

**WORKING
DRAFT**

**INCITS XXX
T10/1545-D**

Revision 5
17 November 2004

INFORMATION TECHNOLOGY - Multimedia Commands – 4 (MMC-4)

This is a draft proposal of the InterNational Committee for Information Technology Standards (INCITS). INCITS is accredited by, and approved under rules approved by, the American National Standards Institute (ANSI). As such this is not a completed standard. The INCITS T10 Technical Committee may modify this document as a result of comments received during public review and its approval as a standard. Use of the information contained herein is at your own risk.

Permission is granted to members of INCITS, its technical committees, and their associated task groups to reproduce this document for the purposes of INCITS standards activities without further permission, provided this notice is included. All other rights are reserved. Any commercial or for-profit replication or re-publication is prohibited.

MMC-4 Technical Editor:

Bill McFerrin, CD Edge, Inc.

P. O. Box 381

Llano, TX 78643

Tel. (325) 423-1560

E-mail: billmc@tstar.net

Reference number
ISO/IEC *****:XXXX
ANSI INCITS .*****:XXXX
Printed: ***** ,XXXX

POINTS OF CONTACT

INCITS T10 Chair

John B. Lohmeyer
LSI Logic Corp.
4420 ArrowsWest Dr.
Colo. Springs, CO 80907-3444
Tel: (719) 533-7560
Fax: (719) 533-7183
Email: lohmeyer@t10.org

INCITS Secretariat

INCITS Secretariat
1250 Eye Street, NW Suite 200
Washington, DC 20005

T10 Reflector

Internet address for subscription to the T10 reflector:
Internet address for distribution via T10 reflector:

Document Distribution

Global Engineering
15 Inverness Way East
Englewood, CO 80112-5704

INCITS T10 Vice-Chair

George O. Penokie
Tivoli Systems Inc.
MS: 2C6
3605 Highway 52 N.
Rochester, MN 55901 USA
Telephone: (507) 253-5208
Facsimile: (507) 253-2880
Email: gpenokie@tivoli.com

Telephone: 202-737-8888
Facsimile: 202-638-4922
e-mail: INCITS@itic.org

majordomo@t10.org
t10@t10.org

Telephone: 303-792-2181 or
800-854-7179
Facsimile: 303-792-2192

**ANSI I
INCITS XXX.200n**

**American National Standards
for Information Technology –**

SCSI Multimedia Commands – 4 (MMC-4)

**Secretariat
InterNational Committee for Information Technology Standards**

Approved DD MM YY

American National Standards Institute, Inc.

Abstract

This standard defines a SCSI based command set needed to access multimedia features. The applicable clauses of this standard when used in conjunction with other standards and publications define a full standard set of commands.

American National Standard

Approval of an American National Standard requires verification by ANSI that the requirements for due process, consensus and other criteria for approval have been met by the standards developer.

Consensus is established when, in the judgment of the ANSI Board of Standards Review, directly and materially affected interests have reached substantial agreement. Substantial agreement means much more than a simple majority, but not necessarily unanimity. Consensus requires that all views and objections be considered and that effort be made towards their resolution.

The use of American National Standards is completely voluntary; their existence does not in any respect preclude anyone, whether he has approved the standards or not, from manufacturing, marketing, purchasing, or using products, processes, or procedures not conforming to the standards.

The American National Standards Institute does not develop standards and in no circumstances give interpretation on any American National Standard. Moreover, no person shall have the right or authority to issue an interpretation of an American National Standard in the name of the American National Standards Institute. Requests for interpretations should be addressed to the secretariat or sponsor whose name appears on the title page of this standard.

CAUTION NOTICE: This American National Standard may be revised or withdrawn at any time. The procedures of the American National Standards Institute require that action be taken periodically to reaffirm, revise, or withdraw this standard. Purchasers of American National Standards may receive current information on all standards by calling or writing the American National Standards Institute.

CAUTION NOTICE: The developers of this standard have requested that holders of patents that may be required for the implementation of this standard disclose such patents to the publisher. However, neither the developers nor the publisher has undertaken a patent search in order to identify, which, if any, patents may apply to this standard. As of the date of publication of this standard and following call for the identification of patents that may be required for the implementation of the standard, no such claims have been made. The developer or publisher in respect to any standard it processes conducts no further patent search. No representation is made or implied that licenses are not required to avoid infringement in the use of this standard.

Published by
American National Standards Institute
11 West 42nd Street, New York, NY 10036

Copyright © 200n by American National Standards Institute
All rights reserved.

Printed in the United States of America

Contents

1	Scope	1
2	References.....	3
2.1	Normative References	3
2.2	Approved References	3
2.3	References Under Development	4
2.4	Other References	4
3	Definitions, Symbols, Abbreviations, and Conventions.....	7
3.1	Definitions.....	7
3.2	List of Abbreviations and Acronyms	18
3.3	Keywords	19
3.4	Conventions	20
3.5	Bit and byte ordering.....	21
4	Multi-Media Device Models.....	23
4.1	General.....	23
4.1.1	Media Organization.....	23
4.1.2	Logical Blocks.....	23
4.1.3	Logical Sub-Divisions of Media	24
4.1.3.1	General.....	24
4.1.3.2	Logical Tracks	24
4.1.3.3	Sessions.....	24
4.1.4	Data cache.....	25
4.1.5	Resets.....	25
4.1.5.1	Reset Types	25
4.1.5.2	Power-On Reset.....	25
4.1.5.3	Hard Reset	26
4.1.5.4	Device Reset.....	26
4.1.6	Error reporting.....	26
4.1.6.1	Unit Attention Conditions.....	26
4.1.6.2	Logical Unit Busy Conditions	26
4.1.6.3	Unable to Write Errors.....	28
4.1.6.4	Deferred Errors.....	28
4.1.7	Removable medium.....	28
4.1.8	Timeouts	30
4.1.8.1	General.....	30
4.1.8.2	Group 1 Timeouts.....	30
4.1.8.3	Group 2 Timeouts.....	31
4.1.8.4	No Timeout Commands	31
4.1.8.5	Group 3 timeout for Real Time Stream recording/playback.....	31
4.1.8.5.1	General	31
4.1.8.5.2	Trace time for requested sectors.....	32
4.1.8.5.3	Exception 1: Time for the initial OPC.....	32
4.1.8.5.4	Exception 2: Sync cache time	33
4.1.8.5.5	Exception 3: Power state transition time to Active state.....	33
4.1.8.5.6	Relationship of Group 3 time unit and Unit length.....	33
4.1.8.6	Recommended Timeout value handling.....	34
4.1.9	Power Management.....	35
4.2	CD Model.....	36
4.2.1	CD Media Organization	36
4.2.2	Recorded CD Media Structure.....	36

4.2.2.1	The CD Frame Structure	36
4.2.2.2	Sub-channel.....	37
4.2.3	Physical Track Topology: Single Session Disc.....	39
4.2.4	Physical track topology – Multi-Session Disc.....	39
4.2.4.1	Sessions	39
4.2.4.2	Tracks	39
4.2.4.3	Frame Addressing	40
4.2.4.4	Q Sub-channel.....	40
4.2.4.5	Q Sub-channel in the Program Area	41
4.2.4.5.1	Types of Q.....	41
4.2.4.5.2	ADR=1 (0001b) – Mode-1 Q.....	41
4.2.4.5.3	ADR=2 (0010b) – Mode-2 Q.....	41
4.2.4.5.4	ADR=3 (0011b) – Mode-3 Q.....	42
4.2.4.6	Q Sub-channel in the Lead-out Area	43
4.2.4.7	Q Sub-channel in the Lead-in Area	43
4.2.4.7.1	Types of Q.....	43
4.2.4.7.2	Mode-1 Q	43
4.2.4.7.3	Mode-2 Q	44
4.2.4.7.4	Mode-5 Q	44
4.2.4.8	CD Main Channel Block Formats	45
4.2.4.8.1	General Data Block Format.....	45
4.2.4.8.2	Block Format for Audio.....	46
4.2.4.8.3	Block Format for Mode 0 Data	46
4.2.4.8.4	Block Format for Mode 1 Data	46
4.2.4.8.5	Block Format for Mode 2 Data	47
4.2.4.9	CD Recordable and CD ReWritable Media Structure.....	48
4.2.4.9.1	ATIP	48
4.2.4.9.2	ATIP Time Codes.....	50
4.2.4.9.3	Special Information	50
4.2.4.9.4	Additional Information	51
4.2.4.10	Blank Media Structure	51
4.2.4.10.1	CD-R Volume 1 and CD-RW.....	51
4.2.4.10.2	CD-R Volume 2	52
4.2.4.10.3	PMA Q Sub-channel	52
4.2.4.11	Recording.....	53
4.2.4.12	The Track Descriptor Block	54
4.2.5	High Speed CD-RW media recording	55
4.2.6	CD Audio error reporting	56
4.2.7	CD ready condition/not ready condition	56
4.2.8	Sensing support for CD-audio commands.....	57
4.3	DDCD Model.....	58
4.3.1	Introduction.....	58
4.3.2	DDCD Specifications.....	58
4.3.2.1	General	58
4.3.2.2	Disc Structure	59
4.3.2.3	Single Session Disc	60
4.3.2.4	Multi-Session Disc	61
4.3.2.5	Physical Sector	61
4.3.2.6	Sector Structure.....	61
4.3.2.7	Sub-Channel Information Formats	62
4.3.2.8	DDCD Ready Condition/Not Ready Condition	62
4.3.2.9	DDCD Address Reporting Format (TIME bit)	63
4.3.2.10	Error Reporting	63
4.3.2.11	Recording for DDCD media.....	64
4.3.2.12	DDCD Recordable and DDCD ReWritable Structure.....	64
4.3.2.13	Packet Layout for DDCD	65

4.4 DVD Model	66
4.4.1 General	66
4.4.2 Physical Media Characteristics	66
4.4.2.1 The Disc	66
4.4.2.2 Track (Groove) Structure	67
4.4.2.3 ECC Blocks	68
4.4.2.3.1 General	68
4.4.2.3.2 The Structure of the Data Sector	68
4.4.2.3.3 The Structure of the ECC Block	69
4.4.2.4 The Lead-in Area	70
4.4.3 DVD-ROM	72
4.4.3.1 Track Structure	72
4.4.3.2 Sector Structure	72
4.4.3.3 The Lead-in	73
4.4.4 DVD-RAM	74
4.4.4.1 Track Structure	74
4.4.4.2 Sector Structure	74
4.4.4.3 The Lead-in	75
4.4.4.4 DVD-RAM Recording	76
4.4.5 DVD-R/-RW	77
4.4.5.1 Track Structure	77
4.4.5.2 Sector Structure	77
4.4.5.3 The Lead-in	78
4.4.5.3.1 Control Data Zone	79
4.4.5.3.2 DVD-R/-RW Physical format information Zone	80
4.4.5.3.3 Extra Border Zone	81
4.4.5.4 DVD-R/-RW Recording	82
4.4.5.4.1 Rzone Description	82
4.4.5.4.2 Border-in/Border-out	82
4.4.5.4.3 RMA Caching	82
4.4.6 DVD+R	83
4.4.6.1 Track Structure	83
4.4.6.1.1 The ADIP (Address in Pre-groove)	83
4.4.6.1.2 The ECC Block	83
4.4.6.1.3 DVD+R Groove Layout	84
4.4.6.2 Recording on DVD+R	85
4.4.6.2.1 Recording Structures	85
4.4.6.2.2 The Initiator's Perspective	88
4.4.6.2.3 Building from a Blank Disc	89
4.4.7 DVD+RW	90
4.4.7.1 Track Structure	90
4.4.7.1.1 The ADIP (Address in Pre-groove)	90
4.4.7.1.2 Logical Structure	90
4.4.7.2 The ECC Block	90
4.4.7.2.1 The Groove Layout	91
4.4.7.3 DVD+RW Basic Format	91
4.4.7.3.1 Reading	91
4.4.7.3.2 Writing	92
4.4.7.3.3 Formatting	92
4.4.8 Disc Control Blocks	93
4.5 The MRW Format for ReWritable Media	94
4.5.1 Overview	94
4.5.2 Consequences of a Multi-Volume Format	94
4.5.2.1 LBA Spaces	94
4.5.2.2 Features and Events	95
4.5.3 Initiator Requests/Logical Unit Responses	95

4.5.3.1	General	95
4.5.3.2	Streamed Writing	95
4.5.3.3	Formatting.....	95
4.5.3.4	Media Specific Implementations	95
4.6	Logical Unit Assisted Software Defect Management	96
4.6.1	General.....	96
4.6.2	Basic actions for defect management.....	96
4.6.3	Software Defect management modes.....	96
4.6.3.1	General	96
4.6.3.2	Persistent defect management (Persistent-DM) mode.....	96
4.6.3.3	Distributed real-time defect management (DRT-DM) mode	97
4.6.4	Enhanced Defect Reporting	97
4.6.4.1	General	97
4.6.4.2	Standard playback model for DVD-RW media	97
4.6.4.3	Four types of defect level.....	97
4.6.4.4	Error reporting control.....	98
4.6.4.5	DBI memory management.....	101
4.6.4.5.1	General.....	101
4.6.4.5.2	Simple DBI memory model	101
4.6.4.5.3	Large DBI buffer memory model.....	101
4.6.4.5.4	Small DBI cache memory model.....	101
4.6.5	Implicit synchronize cache	103
4.6.6	Persistent-DM mode behavior.....	104
4.6.6.1	General	104
4.6.6.2	RECOVERED ERROR reporting control for Persistent-DM mode.....	104
4.6.6.3	Recommend Initiator sequence of Persistent-DM mode	105
4.6.7	DRT-DM mode behavior	105
4.6.7.1	General	105
4.6.7.2	Defect Level Transition model	105
4.6.7.3	Certification.....	106
4.6.7.4	Detecting the use of a defective block.....	106
4.6.7.5	Management of defective block.....	107
4.6.7.6	Delayed replacement of data on defective block.....	107
4.6.7.7	RECOVERED ERROR reporting control for DRT-DM mode	107
4.7	Real-Time Stream Recording/Playback Model	109
4.7.1	General.....	109
4.7.2	Real-Time Stream Playback	109
4.7.3	Error Handling with Hardware or No Defect Management.....	110
4.7.4	Real-Time Stream Recording.....	111
4.7.5	Error Handling with Hardware or No Defect Management.....	112
4.7.6	Error Handling with Software Defect Management.....	112
4.7.7	Fatal error recovery model with Group 3 time-out	112
4.8	Write Protect	114
4.8.1	Types of Write Protect.....	114
4.8.2	SWPP.....	114
4.8.3	CWP.....	115
4.8.4	MSWI.....	115
4.8.5	PWP	115
4.8.6	WDCB	115
4.8.7	Event Reporting.....	115
4.8.8	Error reporting	116
4.9	Changer Model.....	117
4.9.1	General.....	117
4.9.2	Side definition.....	117
4.9.2.1	Overview	117

4.9.2.2	Side Changing Only Logical Unit	118
4.9.2.3	Attention Conditions for Sided Discs.....	118
4.9.2.4	Error Conditions for Sided Discs	118
4.9.2.5	Initialization.....	119
4.9.3	Changer Addressing	120
4.9.4	Automatic Load and Unload Operations.....	120
4.9.5	Delayed Disc load operation.....	120
4.9.6	Prevent / Allow processing	121
4.9.7	Error Reporting for Changers	121
5	Features and Profiles for Multi-Media Devices.....	122
5.1	Introduction	122
5.2	Features	122
5.2.1	Overview	122
5.2.2	Version field	123
5.2.3	Persistent Bit.....	123
5.2.4	Current Bit.....	123
5.2.5	Additional Length Field	123
5.2.6	Feature Codes	123
5.3	Feature Definitions	126
5.3.1	Profile List Feature (0000h)	126
5.3.2	Core Feature (0001h)	128
5.3.3	Morphing Feature (0002h).....	130
5.3.4	Removable Medium Feature (0003h).....	131
5.3.5	Write Protect Feature (0004h)	133
5.3.6	Random Readable Feature (0010h).....	134
5.3.7	Multi-Read Feature (001Dh).....	136
5.3.8	CD Read Feature (001Eh).....	137
5.3.9	DVD Read Feature (001Fh).....	138
5.3.10	Random Writable Feature (0020h)	139
5.3.11	Incremental Streaming Writable (0021h).....	141
5.3.12	Sector Erasable Feature (0022h)	143
5.3.13	Formattable Feature (0023h).....	144
5.3.14	Hardware Defect Management Feature (0024h).....	145
5.3.15	Write Once Feature (0025h).....	146
5.3.16	Restricted Overwrite Feature (0026h)	148
5.3.17	CD-RW CAV Write Feature (0027h).....	149
5.3.18	The MRW Feature (0028h).....	150
5.3.19	Enhanced Defect Reporting Feature (0029h).....	152
5.3.20	DVD+RW Feature (002Ah).....	154
5.3.21	DVD+R Feature (002Bh)	156
5.3.22	Rigid Restricted Overwrite Feature (002Ch)	157
5.3.23	CD Track at Once Feature (002Dh)	159
5.3.24	CD Mastering (Session at Once) Feature (002Eh)	161
5.3.25	DVD-R/-RW Write Feature (002Fh).....	163
5.3.26	Double Density CD Read Feature (0030h).....	164
5.3.27	Double Density CD-R Write Feature (0031h).....	165
5.3.28	Double Density CD-RW Write Feature (0032h).....	166
5.3.29	CD-RW Media Write Support Feature (0037h).....	167
5.3.30	Power Management Feature (0100h).....	168
5.3.31	S.M.A.R.T. Feature (0101h)	169
5.3.32	Embedded Changer Feature (0102h).....	170
5.3.33	CD Audio External Play Feature (0103h)	171
5.3.34	Microcode Upgrade Feature (0104h)	173
5.3.35	Timeout Feature (0105h).....	174

5.3.36	DVD CSS Feature (0106h)	175
5.3.37	Real Time Streaming Feature (0107h).....	176
5.3.38	Logical Unit Serial Number Feature (0108h)	178
5.3.39	Media Serial Number Feature (0109h).....	179
5.3.40	Disc Control Blocks Feature (010Ah).....	180
5.3.41	DVD CPRM Feature (010Bh).....	181
5.3.42	Firmware Information Feature (010Ch).....	182
5.4	Profile Definitions.....	184
5.4.1	Overview	184
5.4.2	Profile 0000h: No Current Profile	184
5.4.3	Profile 0001h: Non-Removable Disk	185
5.4.4	Profile 0002h: Removable Disk.....	186
5.4.5	Profile 0003h: Magneto-Optical Erasable	187
5.4.6	Profile 0004h: Optical Write Once.....	188
5.4.7	Profile 0005h: AS-MO	189
5.4.8	Profile 0008h: CD-ROM	190
5.4.9	Profile 0009h: CD-R	191
5.4.10	Profile 000Ah: CD-RW	193
5.4.11	Profile 0010h: DVD-ROM.....	195
5.4.12	Profile 0011h: DVD-R Sequential recording	196
5.4.13	Profile 0012h: DVD-RAM	198
5.4.14	Profile 0013h: DVD-RW Restricted Overwrite	199
5.4.15	Profile 0014h: DVD-RW Sequential recording	201
5.4.16	Profile 001Ah: DVD+RW	203
5.4.17	Profile 001Bh: DVD+R	205
5.4.18	Profile 0020h: DDCCD-ROM	207
5.4.19	Profile 0021h: DDCCD-R.....	208
5.4.20	Profile 0022h: DDCCD-RW	209
5.4.21	Profile FFFFh: Logical Units Not Conforming to a Standard Profile	211
6	Commands for Multi-Media Devices	212
6.1	Overview.....	212
6.2	BLANK Command	214
6.2.1	Introduction.....	214
6.2.2	The CDB and its Parameters	214
6.2.2.1	The CDB	214
6.2.2.2	IMMED	214
6.2.2.3	Blanking Type	214
6.2.2.4	Start Address/Track Number	214
6.2.3	Command Execution	217
6.2.4	Timeouts.....	217
6.2.5	Error Reporting.....	217
6.3	CLOSE TRACK/SESSION Command.....	218
6.3.1	Introduction.....	218
6.3.2	The CDB and its Parameters	218
6.3.2.1	The CDB	218
6.3.2.2	IMMED	218
6.3.2.3	Close Functions	218
6.3.2.4	Track Number	218
6.3.3	Command Execution	221
6.3.4	Timeouts.....	222
6.3.5	Error Reporting.....	222
6.4	ERASE (10) Command	223
6.4.1	Introduction.....	223
6.4.2	The CDB and its Parameters	223

6.4.2.1	The CDB.....	223
6.4.2.2	ERA.....	223
6.4.2.3	IMMED.....	223
6.4.2.4	RelAdr.....	223
6.4.2.5	Logical Block Address.....	223
6.4.2.6	Number of Blocks.....	223
6.4.3	Command Execution.....	224
6.4.4	Timeouts.....	224
6.4.5	Error Reporting.....	224
6.5	FORMAT UNIT Command.....	225
6.5.1	Introduction.....	225
6.5.2	The CDB and Its Parameters.....	225
6.5.2.1	The CDB.....	225
6.5.2.2	FmtData.....	225
6.5.2.3	CmpList.....	225
6.5.2.4	Format Code.....	226
6.5.2.5	Interleave Value.....	226
6.5.3	Format Parameter List.....	226
6.5.3.1	List Format.....	226
6.5.3.2	Format List Header.....	226
6.5.3.3	Initialization Pattern.....	228
6.5.3.4	Format Descriptor.....	229
6.5.3.4.1	Format Type = 00h (Full Format).....	230
6.5.3.4.2	Format Type = 01h (Spare Area Expansion).....	230
6.5.3.4.3	Format Type = 04h (Zone Reformat).....	230
6.5.3.4.4	Format Type = 05h (Zone Format).....	230
6.5.3.4.5	Format Type = 10h (CD/DVD-RW Full Format).....	230
6.5.3.4.6	Format Type = 11h (CD/DVD-RW Grow Session).....	231
6.5.3.4.7	Format Type = 12h (CD/DVD-RW Add Session).....	231
6.5.3.4.8	Format Type = 13h (DVD-RW Quick Grow the last Session).....	231
6.5.3.4.9	Format Type = 14h (DVD-RW Quick Add Session).....	232
6.5.3.4.10	Format Type = 15h (DVD-RW Quick).....	232
6.5.3.4.11	Format Types = 24h, (MRW Full Format).....	232
6.5.3.4.12	Format Type = 26h, (DVD+RW Basic Format).....	233
6.5.4	Command Execution.....	234
6.5.4.1	Overview.....	234
6.5.4.2	Use of the IMMED Bit.....	234
6.5.4.3	Background Formatting.....	234
6.5.4.3.1	Overview.....	234
6.5.4.3.2	The Foreground Part of the Format Process.....	235
6.5.4.3.3	The Background Format Process.....	235
6.5.4.3.4	Stopping and Restarting Background Format.....	235
6.5.4.3.5	Writing During the Background Format Process.....	237
6.5.4.3.6	Recovering an Incomplete Format.....	237
6.5.5	Timeouts.....	237
6.5.6	Error Reporting.....	237
6.6	GET CONFIGURATION Command.....	238
6.6.1	The CDB and its Parameters.....	238
6.6.1.1	The CDB.....	238
6.6.1.2	RT.....	238
6.6.1.3	Starting Feature Number.....	239
6.6.1.4	Allocation Length.....	239
6.6.2	Command Execution.....	239
6.6.2.1	GET CONFIGURATION Response Data.....	239
6.6.2.2	Features.....	240

6.6.2.3	Profile List	240
6.6.3	Timeouts.....	240
6.6.4	Error Reporting.....	240
6.7	GET EVENT STATUS NOTIFICATION Command	241
6.7.1	The CDB and its Parameters	241
6.7.1.1	The CDB	241
6.7.1.2	Polled	241
6.7.1.3	Notification Class Request.....	242
6.7.1.4	Allocation Length	242
6.7.2	Command Execution	242
6.7.2.1	Event Status Notification Data.....	242
6.7.2.2	Operational Change Events.....	244
6.7.2.3	Power Management Events.....	245
6.7.2.4	External Request Events	246
6.7.2.5	Media Events	248
6.7.2.5.1	Event Code.....	248
6.7.2.5.2	Media Status	248
6.7.2.5.3	Start Slot.....	249
6.7.2.5.4	End Slot.....	249
6.7.2.6	Multiple Initiator Events.....	250
6.7.2.7	Device Busy Events.....	251
6.7.3	Timeouts.....	253
6.7.4	Error Reporting.....	253
6.8	GET PERFORMANCE Command	254
6.8.1	Introduction.....	254
6.8.2	The CDB and its Parameters	254
6.8.2.1	The CDB	254
6.8.2.2	Data Type	254
6.8.2.3	Starting LBA.....	254
6.8.2.4	Maximum Number of Descriptors	254
6.8.2.5	Type.....	255
6.8.3	Command Execution	255
6.8.3.1	Overview	255
6.8.3.2	Performance (Type field = 00h).....	255
6.8.3.3	Unusable Area Data (Type=01h).....	257
6.8.3.4	Defect Status data (Type=02h).....	258
6.8.3.5	Write Speed (Type=03h).....	259
6.8.3.6	DBI (Type=04h)	261
6.8.3.7	DBI cache zone (Type=05h).....	262
6.8.4	Timeouts.....	263
6.8.5	Error Reporting.....	263
6.9	INQUIRY Command	264
6.9.1	Introduction.....	264
6.9.2	INQUIRY Data for ATAPI and USB Logical Units.....	264
6.9.3	Timeouts.....	264
6.9.4	Error Reporting.....	264
6.10	LOAD/UNLOAD MEDIUM Command.....	265
6.10.1	Introduction.....	265
6.10.2	The CDB and its Parameters	265
6.10.2.1	The CDB	265
6.10.2.2	IMMED	265
6.10.2.3	Start and LoUnlo	265
6.10.2.4	Slot.....	265
6.10.3	Command Execution	266
6.10.4	Timeouts.....	266

6.10.5	Error Reporting	266
6.11	MECHANISM STATUS Command.....	267
6.11.1	Introduction	267
6.11.2	The CDB and its Parameters.....	267
6.11.3	Command Execution	267
6.11.3.1	Mechanism Status Parameter List.....	267
6.11.4	Timeouts	269
6.11.5	Error Reporting	270
6.12	MODE SELECT (10) Command.....	271
6.12.1	Introduction	271
6.12.2	Timeouts	271
6.12.3	Error Reporting	271
6.13	MODE SENSE (10) Command.....	272
6.13.1	Introduction	272
6.13.2	Timeouts	272
6.13.3	Error Reporting	272
6.14	PAUSE/RESUME Command.....	273
6.14.1	Introduction	273
6.14.2	The CDB and Its Parameters.....	273
6.14.3	Command Execution	273
6.14.3.1	Pause	273
6.14.3.2	Resume	273
6.14.4	Timeouts	274
6.14.5	Error Reporting	274
6.15	PLAY AUDIO (10) Command.....	275
6.15.1	Introduction	275
6.15.2	The CDB and Its Parameters.....	275
6.15.2.1	The CDB.....	275
6.15.2.2	RelAdr	275
6.15.2.3	Starting Logical Block Address	275
6.15.2.4	Play Length	275
6.15.3	Command Execution	275
6.15.4	Timeouts	276
6.15.5	Error Reporting	276
6.16	PLAY AUDIO (12) Command.....	277
6.16.1	Introduction	277
6.16.2	The CDB and Its Parameters.....	277
6.16.3	Command Execution	277
6.16.4	Timeouts	277
6.16.5	Error Reporting	278
6.17	PLAY AUDIO MSF Command.....	279
6.17.1	Introduction	279
6.17.2	The CDB and its Parameters.....	279
6.17.2.1	The CDB.....	279
6.17.2.2	Starting M Field, Starting S Field, Starting F Field.....	279
6.17.2.3	Ending M Field, Ending S Field, Ending F Field	279
6.17.3	Command Execution	280
6.17.4	Timeouts	280
6.17.5	Error Reporting	280
6.18	PREVENT ALLOW MEDIUM REMOVAL Command	281
6.18.1	Introduction	281
6.18.2	The CDB and its Parameters.....	281
6.18.3	Command Execution	281
6.18.3.1	Overview	281

6.18.3.2	Persistent Prevent State	281
6.18.3.3	Prevent State	282
6.18.4	Timeouts.....	282
6.18.5	Error Reporting.....	283
6.19	READ (10) Command	284
6.19.1	Introduction.....	284
6.19.2	The CDB and Its Parameters	284
6.19.2.1	The CDB	284
6.19.2.2	DPO	284
6.19.2.3	FUA.....	284
6.19.2.4	RelAdr	284
6.19.2.5	Logical Block Address	284
6.19.2.6	Transfer Length.....	285
6.19.3	Command Execution	285
6.19.4	Timeouts.....	285
6.19.5	Error Reporting.....	285
6.20	READ (12) Command	286
6.20.1	Introduction.....	286
6.20.2	The CDB and Its Parameters	286
6.20.2.1	The CDB	286
6.20.2.2	DPO	286
6.20.2.3	FUA.....	286
6.20.2.4	RelAdr	286
6.20.2.5	Logical Block Address	287
6.20.2.6	Transfer Length.....	287
6.20.2.7	Streaming.....	287
6.20.3	Command Execution	287
6.20.4	Timeouts.....	287
6.20.5	Error Reporting.....	288
6.21	READ BUFFER Command.....	289
6.21.1	Introduction.....	289
6.21.2	Timeouts.....	289
6.21.3	Error Reporting.....	289
6.22	READ BUFFER CAPACITY Command.....	290
6.22.1	Introduction.....	290
6.22.2	The CDB and Its Parameters	290
6.22.2.1	The CDB	290
6.22.2.2	BLOCK.....	290
6.22.2.3	Allocation Length	290
6.22.3	Command Execution	290
6.22.3.1	Reporting Available Buffer in Bytes	290
6.22.3.2	Reporting Available Buffer in Blocks	291
6.22.4	Timeouts.....	292
6.22.5	Error Reporting.....	292
6.23	READ CAPACITY Command	293
6.23.1	Introduction.....	293
6.23.2	The CDB and Its Parameters	293
6.23.2.1	The CDB	293
6.23.2.2	RelAdr	293
6.23.2.3	Logical Block Address	293
6.23.2.4	PMI.....	293
6.23.3	Command Execution	293
6.23.4	Timeouts.....	294
6.23.5	Error Reporting.....	295

6.24 READ CD Command	296
6.24.1 Introduction	296
6.24.2 The CDB and Its Parameters	296
6.24.2.1 The CDB	296
6.24.2.2 Expected Sector Type	296
6.24.2.3 DAP	297
6.24.2.4 RelAdr	297
6.24.2.5 Starting Logical Block Address	297
6.24.2.6 Transfer Length	297
6.24.2.7 Main Channel Selection Bits	298
6.24.2.8 C2 Error Information	299
6.24.2.9 Sub-channel Selection bits	300
6.24.3 Command Execution	300
6.24.3.1 Main Channel Field Formats	300
6.24.3.1.1 Sync Field	300
6.24.3.1.2 Headers	300
6.24.3.1.3 User Data	301
6.24.3.1.4 EDC and ECC	301
6.24.3.1.5 C2 Errors	301
6.24.3.2 Sub-Channel Field Formats	301
6.24.3.2.1 Overview	301
6.24.3.2.2 RAW P-W Sub-channel	301
6.24.3.2.3 P and Q Sub-Channel	302
6.24.3.2.4 Corrected and De-interleaved R-W Sub-channel	302
6.24.3.2.5 CD-Text	302
6.24.4 Timeouts	303
6.24.5 Error Reporting	303
6.25 READ CD MSF Command	304
6.25.1 Introduction	304
6.25.2 The CDB and Its Parameters	304
6.25.2.1 The CDB	304
6.25.2.2 Expected Sector Type	304
6.25.2.3 DAP	304
6.25.2.4 Starting M, Starting S, and Starting F Fields	304
6.25.2.5 Ending M, Ending S, and Ending F Fields	304
6.25.2.6 Main Channel Selection bits	305
6.25.2.7 C2 Error Information	305
6.25.2.8 Sub-channel Selection bits	305
6.25.3 Command Execution	305
6.25.4 Timeouts	305
6.25.5 Error Reporting	305
6.26 READ DISC INFORMATION Command	306
6.26.1 Introduction	306
6.26.2 The CDB and Its Parameters	306
6.26.3 Command Execution	306
6.26.3.1 Overview	306
6.26.3.2 Disc Information Length	307
6.26.3.3 Erasable Bit	307
6.26.3.4 State of Last Session	308
6.26.3.5 Disc Status	308
6.26.3.6 Number of First Track on Disc	308
6.26.3.7 First Track Number in Last Session	308
6.26.3.8 Last Track Number in Last Session	309
6.26.3.9 DID_V Bit	309
6.26.3.10 DBC_V Bit	309

6.26.3.11	URU Bit	309
6.26.3.12	DAC_V	309
6.26.3.13	Dbit	309
6.26.3.14	BG Format Status	309
6.26.3.15	Disc Type	309
6.26.3.16	Disc Identification Number	310
6.26.3.17	Last Session Lead-in Start Address	310
6.26.3.18	Last Possible Lead-out Start Address	310
6.26.3.19	Disc Bar Code	310
6.26.3.20	Disc Application Code	310
6.26.3.21	OPC Table	311
6.26.4	Timeouts	311
6.26.5	Error Reporting	311
6.27	READ DVD STRUCTURE Command	312
6.27.1	Introduction	312
6.27.2	The CDB and Its Parameters	312
6.27.2.1	The CDB	312
6.27.2.2	Address	312
6.27.2.3	Layer Number	312
6.27.2.4	Format	312
6.27.2.5	Allocation Length	312
6.27.2.6	AGID	313
6.27.3	Command Execution	314
6.27.3.1	Format Code 00h: Physical Format Information	314
6.27.3.2	Format Code 01h: DVD Copyright Information	318
6.27.3.3	Format Code 02h: Disc Key	319
6.27.3.4	Format Code 03h: BCA Information	320
6.27.3.5	Format Code 04h: DVD Disc Manufacturing Information	321
6.27.3.6	Format Code 05h: Copyright Management Information	322
6.27.3.7	Format Code 06h: Media Identifier	324
6.27.3.8	Format Code 07h: Media Key Block	325
6.27.3.9	Format Code 08h: DVD-RAM Disc Definition Structure (DDS)	326
6.27.3.10	Format Code 09h: DVD-RAM Medium Status	327
6.27.3.11	Format Code 0Ah: DVD-RAM Spare Area Information	329
6.27.3.12	Format Code 0Bh: DVD-RAM Recording Type Information	330
6.27.3.13	Format Code 0Ch: RMD in the last Border-out	331
6.27.3.14	Format Code 0Dh: Recording Management Area Data	332
6.27.3.15	Format Code 0Eh: Pre-recorded Information in Lead-in	333
6.27.3.16	Format Code 0Fh: Unique Disc Identifier	334
6.27.3.17	Format Code 10h: Format Information of Control Data Zone in the Lead-in	335
6.27.3.18	Format Code 11h: ADIP Information	336
6.27.3.19	Format Code 30h: Disc Control Blocks	336
6.27.3.19.1	Overview	336
6.27.3.19.2	Formatting DCB (FDCB)	337
6.27.3.19.3	Write Inhibit DCB (WDCB)	337
6.27.3.19.4	Session DCB	339
6.27.3.19.5	DCB List	340
6.27.3.20	Format Code 31h: Read MTA ECC Block	341
6.27.3.21	Format Code C0h: Write Protection Status	342
6.27.3.22	Format Code FFh: DVD Structure List	343
6.27.4	Timeouts	344
6.27.5	Error Reporting	344
6.28	READ FORMAT CAPACITIES Command	345
6.28.1	Introduction	345
6.28.2	The CDB and Its Parameters	345

6.28.2.1	The CDB.....	345
6.28.3	Command Execution	346
6.28.3.1	Capacity List Header	346
6.28.3.2	Current/Maximum Capacity Descriptor	347
6.28.3.3	Formattable Capacity Descriptors.....	348
6.28.4	Timeouts	350
6.28.5	Error Reporting	350
6.29	READ SUB-CHANNEL Command.....	351
6.29.1	Introduction	351
6.29.2	The CDB and Its Parameters.....	351
6.29.2.1	The CDB.....	351
6.29.2.2	TIME	351
6.29.2.3	SUBQ	351
6.29.2.4	Sub-channel Parameter List.....	351
6.29.2.5	Track Number.....	352
6.29.2.6	Allocation Length.....	352
6.29.3	Command Execution	352
6.29.3.1	Overview	352
6.29.3.2	Sub-Channel Data Header.....	352
6.29.3.3	CD Current Position	353
6.29.3.4	Media Catalog Number	355
6.29.3.5	International Standard Recording Code (ISRC).....	356
6.29.4	Timeouts	357
6.29.5	Error Reporting	357
6.30	READ TOC/PMA/ATIP Command	358
6.30.1	Introduction	358
6.30.2	The CDB and Its Parameters.....	358
6.30.2.1	The CDB.....	358
6.30.2.2	TIME	358
6.30.2.3	Format	358
6.30.2.4	Track/Session Number.....	358
6.30.2.5	Allocation Length.....	358
6.30.3	Command Execution	359
6.30.3.1	Overview	359
6.30.3.2	Response Format 0000b: Formatted TOC.....	360
6.30.3.2.1	General	360
6.30.3.2.2	General Case for CD	360
6.30.3.2.3	MRW Deviations	361
6.30.3.2.4	DCCD Deviations.....	361
6.30.3.2.5	DVD-ROM, DVD-RAM, DVD+RW, and Single Session DVD-R/-RW, DVD+R.....	362
6.30.3.2.6	DVD-R/-RW with Multiple Sessions.....	362
6.30.3.2.7	DVD+R with Multiple Sessions	362
6.30.3.3	Response Format 0001b: Multi-session Information	363
6.30.3.3.1	General	363
6.30.3.3.2	MRW Deviations	363
6.30.3.3.3	DVD-ROM, DVD-RAM, DVD+RW, DVD-R/-RW, and DVD+R.....	364
6.30.3.4	Response Format 0010b: Raw TOC.....	365
6.30.3.4.1	General	365
6.30.3.4.2	CD-MRW Deviations	368
6.30.3.4.3	DVD-ROM, DVD-RAM, DVD+RW, DVD+R, and DVD-R/-RW	368
6.30.3.5	Response Format 0011b: PMA.....	369
6.30.3.5.1	General	369
6.30.3.5.2	CD-MRW Deviations	369
6.30.3.5.3	DVD-ROM, DVD-RAM, DVD+RW, DVD+R, and DVD-R/-RW	369
6.30.3.6	Response Format 0100b: ATIP.....	370

6.30.3.6.1	General.....	370
6.30.3.6.2	ATIP Descriptor for CD-R/RW Media.....	371
6.30.3.6.3	ATIP Descriptor for DDCD-R/RW Media.....	372
6.30.3.6.4	TOC/PMA/ATIP Format 0100b for DVD Media.....	372
6.30.3.7	Response Format 0101b: CD-TEXT.....	373
6.30.4	Timeouts.....	373
6.30.5	Error Reporting.....	373
6.31	READ TRACK INFORMATION Command.....	374
6.31.1	Introduction.....	374
6.31.2	The CDB and Its Parameters.....	374
6.31.2.1	The CDB.....	374
6.31.2.2	Address/Number Type.....	374
6.31.2.3	Logical BlockAddress/Track/Session Number Fields.....	374
6.31.2.4	Allocation Length.....	375
6.31.3	Command Execution.....	375
6.31.3.1	Overview.....	375
6.31.3.2	Data Length.....	376
6.31.3.3	Track Number.....	376
6.31.3.4	Session Number.....	377
6.31.3.5	Copy bit.....	377
6.31.3.6	Damage Bit.....	377
6.31.3.7	Track Mode.....	377
6.31.3.8	Track Status: RT, Blank, Packet, and FP Bits.....	377
6.31.3.9	Data Mode.....	380
6.31.3.10	NWA_V.....	380
6.31.3.11	LRA_V.....	381
6.31.3.12	Track Start Address.....	381
6.31.3.13	Next Writable Address.....	381
6.31.3.14	Free Blocks.....	382
6.31.3.15	Fixed Packet Size.....	382
6.31.3.16	Track Size.....	382
6.31.3.16.1	General.....	382
6.31.3.16.2	CD and DDCD Track Size.....	382
6.31.3.16.3	DVD-ROM Track Size.....	383
6.31.3.16.4	DVD-RAM Track Size.....	383
6.31.3.16.5	DVD-R/RW Track Size.....	383
6.31.3.16.6	DVD+RW Track Size.....	384
6.31.3.16.7	DVD+R Track Size.....	384
6.31.3.17	Last Recorded Address.....	384
6.31.3.18	Read Compatibility LBA.....	384
6.31.4	Timeouts.....	384
6.31.5	Error Reporting.....	385
6.32	REPAIR TRACK Command.....	386
6.32.1	Introduction.....	386
6.32.2	The CDB and Its Parameters.....	386
6.32.2.1	The CDB.....	386
6.32.2.2	IMMED.....	386
6.32.2.3	Track Number.....	386
6.32.3	Command Execution.....	386
6.32.4	Timeouts.....	386
6.32.5	Error Reporting.....	387
6.33	REPORT KEY Command.....	388
6.33.1	Introduction.....	388
6.33.2	The CDB and Its Parameters.....	388
6.33.2.1	The CDB.....	388

6.33.2.2	Reserved/Logical Block Address	388
6.33.2.3	Key Class	388
6.33.2.4	Allocation Length.....	389
6.33.2.5	AGID.....	389
6.33.2.6	KEY Format.....	389
6.33.3	Command Execution	390
6.33.3.1	Key Format = 000000b, AGID for CSS/CPPM.....	390
6.33.3.2	Key Format = 000001b, Challenge Key	390
6.33.3.3	Key Format = 000010b, KEY1	391
6.33.3.4	Key Format = 000100b, TITLE KEY	391
6.33.3.5	Key Format = 000101b, Authentication Success Flag.....	392
6.33.3.6	Key Format = 001000b, RPC State	393
6.33.3.7	Key Format = 010001b, AGID for CPRM.....	394
6.33.3.8	Key Format = 111111b, Invalidate AGID	394
6.33.4	Timeouts	394
6.33.5	Error Reporting	394
6.34	REQUEST SENSE Command.....	395
6.34.1	Introduction	395
6.34.2	Timeouts	395
6.34.3	Error Reporting	395
6.35	RESERVE TRACK Command.....	396
6.35.1	Introduction	396
6.35.2	The CDB and Its Parameters.....	396
6.35.3	Command Execution	397
6.35.3.1	General.....	397
6.35.3.2	Track Reservation on CD-R/RW Media	397
6.35.3.3	Track (Rzone) Reservation on DVD-R/RW Media.....	397
6.35.3.4	Track (Fragment) Reservation on DVD+R Media	398
6.35.4	Timeouts	398
6.35.5	Error Reporting	398
6.36	SCAN Command	399
6.36.1	Introduction	399
6.36.2	The CDB and Its Parameters.....	399
6.36.2.1	The CDB.....	399
6.36.2.2	Direction	399
6.36.2.3	RelAdr	399
6.36.2.4	Scan Starting Address.....	399
6.36.2.5	Type.....	399
6.36.3	Command Execution	400
6.36.4	Timeouts	400
6.36.5	Error Reporting	400
6.37	SEEK (10) Command	401
6.37.1	Introduction	401
6.37.2	The CDB and Its Parameters.....	401
6.37.2.1	The CDB.....	401
6.37.2.2	Logical Block Address	401
6.37.3	Command Execution	401
6.37.4	Timeouts	401
6.37.5	Error Reporting	402
6.38	SEND CUE SHEET Command.....	403
6.38.1	Introduction	403
6.38.2	The CDB and Its Parameters.....	403
6.38.2.1	The CDB.....	403
6.38.3	Command Execution	403
6.38.3.1	General.....	403

6.38.3.2	Information of the Absolute Disc Location	404
6.38.3.3	Control/Address Field	405
6.38.3.4	CTL Field (upper 4 bits)	405
6.38.3.5	ADR Field (lower 4 bits)	406
6.38.3.6	TNO	406
6.38.3.7	INDEX Field	406
6.38.3.8	Data Form	406
6.38.3.9	SCMS (Serial Copy Management System)	406
6.38.3.10	Data Form of Main Data	406
6.38.3.11	CD-DA Data Form	407
6.38.3.12	CD-ROM mode 1 Form	407
6.38.3.13	CD-ROM XA, CD-I Form	408
6.38.3.14	CD-ROM mode 2	408
6.38.3.15	Data Form of Sub-channel	409
6.38.3.16	Absolute Time	410
6.38.3.17	Session Format	410
6.38.3.18	Pre-gap	410
6.38.3.19	Post-gap	410
6.38.3.20	Media Catalog Number	410
6.38.3.21	ISRC	411
6.38.4	Timeouts	411
6.38.5	Error Reporting	411
6.39	SEND DVD STRUCTURE Command	412
6.39.1	Introduction	412
6.39.2	The CDB and Its Parameters	412
6.39.2.1	The CDB	412
6.39.2.2	Format	412
6.39.2.3	Parameter List Length	413
6.39.3	Command Execution	413
6.39.3.1	General	413
6.39.3.2	Format Code = 04h: User Specific Data	413
6.39.3.3	Format Code = 05h: Copyright Management Information	414
6.39.4	Format Code = 0Fh: Timestamp	416
6.39.5	Format Code = 30h: Disc Control Block	417
6.39.5.1	General	417
6.39.5.2	Erasing a DCB	417
6.39.5.3	Write Inhibit DCB	417
6.39.6	Format Code = C0h: Write Protection	419
6.39.7	Timeouts	419
6.39.8	Error Reporting	419
6.40	SEND KEY Command	420
6.40.1	Introduction	420
6.40.2	The CDB and Its Parameters	420
6.40.2.1	The CDB	420
6.40.2.2	Key Class	420
6.40.2.3	Parameter List Length	420
6.40.2.4	AGID	421
6.40.2.5	KEY Format	421
6.40.3	Command Execution	421
6.40.4	Timeouts	423
6.40.5	Error Reporting	423
6.41	SEND OPC INFORMATION Command	424
6.41.1	Introduction	424
6.41.2	The CDB and Its Parameters	424
6.41.2.1	The CDB	424

6.41.2.2	DoOpc	424
6.41.2.3	Parameter List Length	424
6.41.3	Command Execution	425
6.41.4	Timeouts	425
6.41.5	Error Reporting	425
6.42	SET CD SPEED Command	426
6.42.1	Introduction	426
6.42.2	The CDB and Its Parameters.....	426
6.42.2.1	The CDB.....	426
6.42.2.2	Rotational Control.....	426
6.42.2.3	Logical Unit Read Speed	426
6.42.2.4	Logical Unit Write Speed.....	427
6.42.3	Command Execution	427
6.42.4	Timeouts	427
6.42.5	Error Reporting	427
6.43	SET READ AHEAD Command	428
6.43.1	Introduction	428
6.43.2	The CDB and Its Parameters.....	428
6.43.2.1	The CDB.....	428
6.43.2.2	Trigger Logical Block Address	428
6.43.2.3	Read-Ahead Logical Block Address.....	428
6.43.3	Command Execution	428
6.43.4	Timeouts	429
6.43.5	Error Reporting	429
6.44	SET STREAMING Command.....	430
6.44.1	Introduction	430
6.44.2	The CDB and Its Parameters.....	430
6.44.2.1	The CDB.....	430
6.44.2.2	Type.....	430
6.44.2.3	Parameter List Length	431
6.44.3	Command Execution	431
6.44.3.1	General.....	431
6.44.3.2	Performance Descriptor (Type=0).....	431
6.44.3.3	DBI cache zone Descriptor (Type=5).....	432
6.44.4	Timeouts	433
6.44.5	Error Reporting	433
6.45	START STOP UNIT Command	434
6.45.1	Introduction	434
6.45.2	The CDB and Its Parameters.....	434
6.45.2.1	The CDB.....	434
6.45.2.2	IMMED	434
6.45.2.3	Power Conditions	434
6.45.2.4	LoEj and Start.....	435
6.45.3	Timeouts	435
6.45.4	Error Reporting	435
6.46	STOP PLAY/SCAN Command.....	436
6.46.1	Introduction	436
6.46.2	The CDB and Its Parameters.....	436
6.46.3	Command Execution	436
6.46.4	Timeouts	437
6.46.5	Error Reporting	437
6.47	SYNCHRONIZE CACHE Command	438
6.47.1	Introduction	438
6.47.2	The CDB and Its Parameters.....	438

6.47.2.1	The CDB	438
6.47.2.2	IMMED	438
6.47.2.3	RelAdr	438
6.47.2.4	Logical Block Address	438
6.47.2.5	Number of Blocks	439
6.47.3	Command Execution	439
6.47.4	Timeouts.....	439
6.47.5	Error Reporting.....	439
6.48	TEST UNIT READY Command.....	440
6.48.1	Introduction.....	440
6.48.2	Timeouts.....	440
6.48.3	Error Reporting.....	440
6.49	VERIFY (10) Command.....	441
6.49.1	Introduction.....	441
6.49.2	The CDB and Its Parameters	441
6.49.2.1	The CDB	441
6.49.2.2	DPO	441
6.49.2.3	BytChk	441
6.49.2.4	RelAdr	441
6.49.2.5	Logical Block Address	441
6.49.2.6	Number of Blocks	441
6.49.2.7	G3tout	441
6.49.3	Command Execution	442
6.49.4	Timeouts.....	442
6.49.5	Error Reporting.....	442
6.50	WRITE (10) Command	443
6.50.1	Introduction.....	443
6.50.2	The CDB and Its Parameters	443
6.50.2.1	The CDB	443
6.50.2.2	DPO	443
6.50.2.3	FUA.....	443
6.50.2.4	RelAdr	444
6.50.2.5	Logical Block Address	444
6.50.2.6	Transfer Length.....	444
6.50.3	Command Execution	444
6.50.3.1	General	444
6.50.3.2	CD-R Fixed Packet, Variable Packet, Track-At-Once	444
6.50.3.3	SAO Raw on CD-R/-RW, DAO and Incremental on DVD-R/-RW	445
6.50.3.4	DVD-RAM	446
6.50.3.5	DVD+R.....	446
6.50.3.6	DVD+RW	446
6.50.4	Timeouts.....	446
6.50.5	Error Reporting.....	447
6.51	WRITE (12) Command	448
6.51.1	Introduction.....	448
6.51.2	The CDB and Its Parameters	448
6.51.2.1	The CDB	448
6.51.2.2	FUA.....	448
6.51.2.3	Logical Block Address	449
6.51.2.4	Transfer Length.....	449
6.51.2.5	Blocking Factor	449
6.51.2.6	Streaming.....	449
6.51.3	Command Execution	449
6.51.4	Timeouts.....	449
6.51.5	Error Reporting.....	450

6.52 WRITE AND VERIFY (10) Command	451
6.52.1 Introduction	451
6.52.2 The CDB and Its Parameters.....	451
6.52.2.1 The CDB.....	451
6.52.2.2 Starting Logical Block Address	451
6.52.2.3 Transfer Length	451
6.52.3 Command Execution	451
6.52.4 Timeouts	452
6.52.5 Error Reporting	452
6.53 WRITE BUFFER Command	453
6.53.1 Introduction	453
6.53.2 Timeouts	453
6.53.3 Error Reporting	453
7 Mode Parameters for Multi-Media Devices	454
7.1 Structure Formats	454
7.1.1 Mode Parameter List	454
7.1.2 Mode Parameter Header Format.....	454
7.1.3 Mode Pages.....	455
7.1.4 Mode Page Format.....	455
7.1.4.1 Parameters Savable bit (PS).....	456
7.1.4.1.1 PS in the MODE SENSE Returned Data	456
7.1.4.1.2 PS in the MODE SELECT Parameter List.....	456
7.1.4.2 Page Code	456
7.1.4.2.1 Page Code in the MODE SENSE Returned Data	456
7.1.4.2.2 Page Code in the MODE SELECT Parameter List	456
7.1.4.3 Page Length	456
7.1.4.3.1 Page Length in the MODE SENSE Returned Data.....	456
7.1.4.3.2 Page Length in the MODE SELECT Parameter List.....	456
7.2 Read/Write Error Recovery Parameters Mode Page (Page Code 01h).....	457
7.2.1 Introduction	457
7.2.2 The Mode Page and its Parameters.....	457
7.2.2.1 The Mode Page.....	457
7.2.2.2 PS.....	457
7.2.2.3 Page Code	457
7.2.2.4 Page Length	457
7.2.2.5 Error Recovery Behavior.....	457
7.2.2.5.1 Automatic Write Reallocation Enabled (AWRE).....	457
7.2.2.5.2 Automatic Read Reallocation Enabled (ARRE)	458
7.2.2.5.3 Transfer Block (TB).....	458
7.2.2.5.4 Read Continuous (RC)	458
7.2.2.5.5 Post Error (PER).....	458
7.2.2.5.6 Disable Transfer on Error (DTE).....	459
7.2.2.5.7 Disable Correction (DCR).....	459
7.2.2.5.8 Error Recovery Cases for CD and DDCD	459
7.2.2.5.9 Error Recovery Cases for DVD	462
7.2.2.6 Read Retry Count.....	462
7.2.2.7 Enhanced Media Certification and Defect Reporting (EMCDR)	462
7.2.2.7.1 Description of PER bit and EMCDR field	462
7.2.2.7.2 In case of Enhanced Defect Reporting Feature is not supported or is not current	463
7.2.2.7.3 In case of Enhanced Defect Reporting Feature is current	463
7.2.2.8 Write Retry Count.....	463
7.3 MRW Mode Page (Page Code 03h).....	464
7.3.1 Introduction	464
7.3.2 The Mode Page and its Parameters.....	464

7.3.2.1	The Mode Page	464
7.3.2.2	PS	464
7.3.2.3	Page Code	464
7.3.2.4	Page Length.....	464
7.3.2.5	LBA Space	464
7.4	Write Parameters Mode Page (Page Code 05h)	465
7.4.1	Introduction.....	465
7.4.2	Applicable Media	465
7.4.3	Exempted Media	465
7.4.4	The Mode Page and its Parameters	465
7.4.4.1	The Mode Page	465
7.4.4.2	PS	466
7.4.4.3	Page Code	466
7.4.4.4	Page Length.....	466
7.4.4.5	BUFE	467
7.4.4.6	LS_V	467
7.4.4.7	Link Size	467
7.4.4.8	Test Write.....	467
7.4.4.9	Write Type.....	467
7.4.4.10	FP	468
7.4.4.11	Copy.....	468
7.4.4.12	Track Mode.....	468
7.4.4.13	Data Block Type.....	468
7.4.4.14	Initiator Application Code.....	469
7.4.4.15	Session Format Code	470
7.4.4.16	Packet Size	470
7.4.4.17	Media Catalog Number (MCN)	470
7.4.4.18	International Standard Recording Code (ISRC)	471
7.5	Caching Mode Page (08h).....	472
7.5.1	Introduction.....	472
7.5.2	The Mode Page and its Parameters	472
7.5.2.1	The Mode Page	472
7.5.2.2	PS	472
7.5.2.3	Page Code	472
7.5.2.4	Page Length.....	472
7.5.2.5	WCE (Write Cache Enable).....	472
7.5.2.6	RCD (Read Cache Disable).....	472
7.6	CD Audio Control Page (Page Code 0Eh).....	473
7.6.1	Introduction.....	473
7.6.2	The Mode Page and its Parameters	473
7.6.2.1	The Mode Page	473
7.6.2.2	PS	473
7.6.2.3	Page Code	473
7.6.2.4	Page Length.....	473
7.6.2.5	IMMED	473
7.6.2.6	SOTC	473
7.6.2.7	CDDA Output Port Channel Selection.....	474
7.6.2.8	Output Port Volume Control.....	474
7.7	Power Condition mode page (Page Code 1Ah).....	475
7.7.1	Introduction.....	475
7.8	Informational Exceptions Control Mode Page (Page Code 1Ch)	476
7.8.1	Introduction.....	476
7.9	Timeout and Protect Page (Page Code 1Dh)	477
7.9.1	Introduction.....	477

7.9.2	The Mode Page and its Parameters.....	477
7.9.2.1	The Mode Page.....	477
7.9.2.2	PS.....	477
7.9.2.3	Page Code.....	477
7.9.2.4	Page Length.....	477
7.9.2.5	G3Enable.....	477
7.9.2.6	TMOE.....	477
7.9.2.7	DISP.....	477
7.9.2.8	SWPP.....	478
7.9.2.9	Group 1 Minimum Timeout.....	478
7.9.2.10	Group 2 Minimum Timeout.....	478
Annex A Implementation Notes: ATA Layer of ATAPI.....		480
A.1 Introduction.....		480
A.2 General.....		480
A.2.1	Terms.....	480
A.2.1.1	Initiator.....	480
A.2.1.2	Device.....	480
A.2.1.3	Command Packet.....	480
A.2.2	Command Packet Format.....	480
A.2.3	Command Status.....	482
A.2.4	No Block Descriptors in MM ATAPI Devices.....	482
A.2.5	Use of Immediate.....	482
A.2.6	Mapping of Reset Functions.....	482
Annex B Implementation Notes: SCSI Parallel Interface.....		484
B.1 Introduction.....		484
B.2 SCSI Signal Utilization.....		484
B.3 Reset Functionality.....		484
B.3.1	Power On Reset.....	484
B.3.2	Hard Reset.....	484
B.3.3	TARGET RESET task management function.....	484
B.3.4	Device Reset.....	484
B.3.5	Power Management and Device Reset in SCSI.....	484
B.3.6	Mapping of reset functions.....	485
Annex C Implementation Notes: SCSI Serial Bus Protocol.....		486
C.1 SBP-2 Definitions.....		486
C.1.1	Command block.....	486
C.1.2	IEEE 1394.....	486
C.1.3	login.....	486
C.1.4	quadlet.....	486
C.1.5	register.....	486
C.1.6	status block.....	486
C.1.7	system memory.....	486
C.1.8	transaction.....	486
C.1.9	unit.....	486
C.1.10	unit architecture.....	486
C.1.11	unit attention.....	486
C.2 SBP-2 Storage Model.....		487
C.2.1	Overview.....	487
C.2.2	Model configuration.....	487
C.2.3	Model operation.....	487
C.2.4	Reconnect /Power reset support (normative).....	488
C.3 Configuration ROM support (normative).....		488

C.3.1	Overview	488
C.3.2	Unit Directory – Command_Set_Spec_ID.....	488
C.3.3	Unit Directory – Command_Set	489
C.3.4	Unit Directory – Command_Set_Revision.....	489
C.3.5	Unit Directory – Logical_Unit_Number.....	489
C.4	Login support (normative).....	489
C.5	Security support (normative)	489
C.6	Status block support (normative).....	489
C.7	Unsolicited Status support (normative).....	490
C.8	Unit attention condition	490
Annex D	Implementation Notes: Universal Serial Bus	492
D.1	USB and Mass Storage Definitions	492
D.2	Bulk Only Mass Storage	494
D.2.1	Scope	494
D.2.2	Bulk-Only Mass Storage Reset (class-specific request).....	494
D.2.3	Get Max LUN (class-specific request).....	495
D.2.4	Initiator/Device Packet Transfer Order.....	495
D.2.5	Command Queuing	495
D.2.6	Standard Descriptors.....	495
D.2.7	Device Descriptor	496
D.2.8	Serial Number	496
D.2.9	Valid Serial Number Characters.....	496
D.3	Descriptors.....	497
D.3.1	Configuration Descriptor	497
D.3.2	Interface Descriptor	497
D.3.3	Endpoint Descriptors	498
D.3.4	Bulk-In Endpoint.....	498
D.3.5	Bulk-Out Endpoint	499
D.4	Command/Data/Status Protocol	500
D.4.1	Command Block Wrapper (CBW)	500
D.4.2	Command Status Wrapper (CSW).....	501
D.5	Data Transfer Conditions	503
D.5.1	Command Transport	503
D.5.2	Data Transport	503
D.5.3	Status Transport.....	503
D.5.4	Phase Error	503
D.5.5	Reset Recovery.....	503
D.5.6	The 13 Cases	503
Annex E	Legacy Specifications	504
E.1	Overview.....	504
E.2	Commands	504
E.2.1	GET EVENT STATUS NOTIFICATION Command – Operational Change Events	504
E.2.2	GET EVENT STATUS NOTIFICATION Command – Device Busy Events	505
E.2.3	FORMAT UNIT Command, Format Code = 111b.....	506
E.2.4	READ TOC/PMA/ATIP Command: CDB Format field definition	507
E.2.5	SEND EVENT Command.....	508
E.3	MODE PARAMETERS.....	511
E.3.1	Block Descriptors	511
E.3.2	CD Device Parameters Mode Page (Page 0Dh)	512
E.3.3	MM Capabilities and Mechanical Status Page (Page Code 2Ah).....	513
Annex F	Error Reporting	518

F.1 Overview	518
F.2 Deferred Errors	518
F.3 Error Lists	518
Annex G Features and Profiles.....	533
G.1 What Is a Feature?	533
G.2 History	533
G.3 Implementation of Features	534
G.4 Compatibility	534
G.5 Summary	534
Annex H Event Reporting Using GESN.....	536
H.1 Introduction	536
H.2 Functional Behavior Guidelines	536
Annex I Power Management	538
I.1 Power Management States	538
I.2 Power State Transitions	539
I.3 Power Management State Diagram.....	540
I.4 Power Management Timers	542
I.5 Standby Timer	542
I.6 Power Management Status Reporting	544
Annex J The MRW Format.....	546
J.1 The CD-MRW Format.....	546
J.1.1 Overview	546
J.1.2 CD-MRW Structure.....	546
J.1.3 CD-MRW Addressing	547
J.1.4 A CD-MRW Example	547
J.1.4.1 General.....	547
J.1.4.2 READ CAPACITY Command.....	548
J.1.4.3 READ DISC INFORMATION Command.....	549
J.1.4.4 READ TRACK INFORMATION Command	550
J.1.4.5 READ TOC/PMA/ATIP Command	551
J.1.4.6 READ (10), READ (12), READ CD, WRITE (10), WRITE AND VERIFY(10), SEEK(10), VERIFY(10) Commands	555
J.1.5 Legacy Considerations	556
J.1.5.1 Overview	556
J.1.5.2 Combinations 1A, 1B: Legacy CD-ROM Logical Unit.....	556
J.1.5.3 Combinations 3A, 3B: Legacy (MMC1) CD-RW Logical Unit	557
J.1.5.4 Combinations 4A, 4B: MRW Compliant CD-RW Logical Unit.....	557
J.1.5.5 Doing the Format.....	558
J.2 The DVD+MRW Format.....	560
J.2.1 Overview	560
J.2.2 DVD+MRW Structure.....	560
J.2.3 Addressing.....	561
J.2.4 Using DVD+MRW	562
J.2.4.1 Overview	562
J.2.4.2 Determining the Format State of a New Media	562
J.2.4.3 Formatting	562
J.2.4.4 Accessing the Media	563

Tables

Table 1 – Busy Condition Examples	27
Table 2 – SK/ASC/ASCQ Specification for Unable to Write Situations	28
Table 3 – Commands with Group 1 Timeout	30
Table 4 – Group 2 Timeout Commands	31
Table 5 – No Timeout Commands	31
Table 6 – Group 3 Timeout Commands	31
Table 7 – Power Conditions	35
Table 8 – Small Frame layout and definition	36
Table 9 – CD Frame Structure from Small Frames	37
Table 10 – Sub-Channel byte layout	37
Table 11 – P-Sub-Channel Layout	38
Table 12 – Q Sub-channel record format	40
Table 13 – ISRC 6 bit character codes (in hexadecimal)	42
Table 14 – Sync Pattern Block Header	45
Table 15 – Mode Zero Data Format	46
Table 16 – Mode 1 Data Format	46
Table 17 – Mode 2 formless block format	47
Table 18 – Mode 2 form 1 data format	47
Table 19 – Mode 2 Formed Sector Sub-header Format	48
Table 20 – Mode 2 form 2 data format	48
Table 21 – ATIP Information Types	49
Table 22 – Block Identifier bits	54
Table 23 – Track Descriptor Block (TDB) header	55
Table 24 – Track Descriptor Unit (TDU) Format	55
Table 25 – Recording Method	55
Table 26 – Not Ready Error Reporting (by command)	57
Table 27 – Realization of higher density	58
Table 28 – Main Parameters of DDCD	59
Table 29 – TIME Address Format	63
Table 30 – Error Conditions and Sense Key	63
Table 31 – ATIP format	64
Table 32 – Block Identifier bits	65
Table 33 – Structure of Control Data ECC Block	70
Table 34 – Physical Format Information	71
Table 35 – Book Type	71
Table 36 – Disc Size	71
Table 37 – DVD-ROM Lead-in Structure	73
Table 38 – Data Area Allocation Definition	73
Table 39 – DVD-RAM Lead-in Structure	75
Table 40 – DVD-RAM Data Area Allocation Definition	75
Table 41 – DVD-RAM (Ver. 1.0) Unique Part of Physical Format Information	76
Table 42 – DVD-RAM (Ver. 2.1) Unique Part of Physical Format Information	76
Table 43 – Lead-in Structure: DVD-RW and DVD-R for General Purpose, ver 2.0	78

Table 44 – Lead-in Structure: DVD-R ver 1.0, DVD-R for Authoring ver 2.0	78
Table 45 – DVD-R/-RW Data Area Allocation Definition	79
Table 46 – DVD-R Ver 1.0/-R for Authoring Ver.2.0 Unique Part of Physical Format Information	79
Table 47 – DVD-RW/-R for General Ver.2.0 Unique Part of Physical Format Information	79
Table 48 – DVD-R/-RW Physical Format Information Zone	80
Table 49 – Data Area Allocation Field in DVD-R/-RW Physical Format Information	80
Table 50 – Unique Part of Physical Format Information in DVD-R/-RW Physical format information	81
Table 51 – DVD+R Format Lay-out	84
Table 52 – Zones of a Session	87
Table 53 – DVD+RW Media Lay-out	91
Table 54 – Returned error code for commands under the Persistent-DM mode	99
Table 55 – Returned error code for READ and VERIFY commands under the DRT-DM mode	99
Table 56 – Returned error code for commands under the DRT-DM mode	99
Table 57 – Returned Deferred error code	100
Table 58 – DBI update for READ and VERIFY command ¹	100
Table 59 – DBI update for WRITE and WRITE AND VERIFY command ¹	100
Table 60 – Example of DBI cache zone image	103
Table 61 – Definition of PER bit and EMCDR field of Persistent-DM mode	104
Table 62 – Definition of PER bit and EMCDR field of DRT-DM mode	108
Table 63 – Stream Playback Operation Error Handling	110
Table 64 – Error Handling on Stream Recording Operation	112
Table 65 – Examples of Write Protection Associated with Media Types	114
Table 66 – Write Protect ASCQ Reporting	116
Table 67 – WDCB Write Protect ASCQ Reporting	116
Table 68 – Commands that shall not cause delayed loads to occur	120
Table 69 – Commands that may cause delayed loads to occur	120
Table 70 – Commands that should not cause delayed loads to occur	121
Table 71 – Error Conditions and Sense Keys for Changer Mechanisms	121
Table 72 – GET CONFIGURATION response data format	122
Table 73 – Feature Header	122
Table 74 – Feature Descriptor generic format	123
Table 75 – Feature Codes	124
Table 76 – Profile List Descriptor Format	126
Table 77 – Profile Descriptor	126
Table 78 – Profile List	127
Table 79 – Core Feature Descriptor Format	128
Table 80 – Core Feature Commands	128
Table 81 – Physical Interface Standard	129
Table 82 – Morphing Descriptor Format	130
Table 83 – Morphing Feature Commands	130
Table 84 – Removable Medium Feature Descriptor Format	131
Table 85 – Loading Mechanism Type	132
Table 86 – Removable Medium Feature Commands	132
Table 87 – Write Protect Feature Descriptor	133

Table 88 – Write Protect Feature Commands	133
Table 89 – Random Readable Feature Descriptor Format.....	134
Table 90 – Random Readable Feature Commands	134
Table 91 – Random Readable Feature Mode Pages	135
Table 92 – Multi-Read Feature Descriptor Format	136
Table 93 – Multi-Read Feature Commands.....	136
Table 94 – CD Read Feature Descriptor Format	137
Table 95 – CD READ Feature Commands	137
Table 96 – DVD Read Feature Descriptor Format.....	138
Table 97 – DVD READ Feature Commands.....	138
Table 98 – Random Writable Feature Descriptor Format.....	139
Table 99 – Random Writable Feature Commands	140
Table 100 – Random Writable Feature Mode Pages	140
Table 101 – Incremental Streaming Writable Feature Descriptor Format	141
Table 102 – Incremental Streaming Writable Feature Commands.....	142
Table 103 – Incremental Streaming Writable Feature Parameters	142
Table 104 – Sector Erasable Feature Descriptor Format	143
Table 105 – Sector Erasable Feature Commands	143
Table 106 – Formattable Feature Descriptor Format	144
Table 107 – Formattable Feature Commands.....	144
Table 108 – Defect Management Feature Descriptor Format	145
Table 109 – Defect Management Feature Commands.....	145
Table 110 – Defect Management Feature Mode Pages.....	145
Table 111 – Write Once Feature Descriptor Format.....	146
Table 112 – Write Once Feature Commands	146
Table 113 – Write Once Feature Mode Pages	147
Table 114 – Restricted Overwrite Feature Descriptor Format.....	148
Table 115 – Restricted Overwrite Feature Commands	148
Table 116 – Restricted Overwrite Feature Mode Pages.....	148
Table 117 – CD-RW CAV Write Feature Commands.....	149
Table 118 – CD-RW CAV Write Feature Parameters.....	149
Table 119 – CD-RW CAV WRITE Feature Descriptor.....	149
Table 120 – MRW Feature Descriptor	150
Table 121 – MRW Feature Commands	150
Table 122 – MRW Feature Parameters	151
Table 123 – MRW Write Feature Commands.....	151
Table 124 – Enhanced Defect Reporting Feature Descriptor.....	152
Table 125 – Relation between Number of DBI cache zones and DBI memory model type	153
Table 126 – Enhanced Defect Reporting Feature Commands.....	153
Table 127 – Enhanced Defect Reporting Feature Parameters.....	153
Table 128 – Enhanced Defect Reporting DRT-DM Feature Commands	153
Table 129 – Enhanced Defect Reporting small DBI cache memory model Feature Commands.....	153
Table 130 – DVD+RW Feature Descriptor	154
Table 131 – Command Support Required by the DVD+RW Feature with Write = 1	154

Table 132 – DVD+R Feature Descriptor	156
Table 133 – Command Support Required by the DVD+R Feature with Write = 1	156
Table 134 – Rigid Restricted Overwrite Feature Descriptor Format	157
Table 135 – Rigid Restricted Overwrite Feature Commands	158
Table 136 – CD Track at Once Feature Descriptor Format	159
Table 137 – CD Track at Once Feature Commands	160
Table 138 – CD Track at Once Feature Mode Parameters	160
Table 139 – CD Mastering Feature Descriptor	161
Table 140 – CD Mastering (Session at Once) Feature Commands	162
Table 141 – CD Mastering (Session at Once) Feature Parameter	162
Table 142 – CD Mastering (RAW) Feature Commands	162
Table 143 – CD Mastering (RAW) Feature Parameters	162
Table 144 – DVD-R/-RW Write Feature Descriptor Format	163
Table 145 – DVD-R/-RW Write Feature Commands	163
Table 146 – DVD-R/-RW Write Feature Parameters	163
Table 147 – DDCCD Read Feature Descriptor Format	164
Table 148 – DDCCD Read Feature Commands	164
Table 149 – DDCCD-R Write Feature Descriptor Format	165
Table 150 – DDCCD-R Write Feature Commands	165
Table 151 – DDCCD-RW Write Feature Descriptor Format	166
Table 152 – DDCCD-RW Write Feature Commands	166
Table 153 – CD-RW Media Write Support Feature Descriptor	167
Table 154 – Power Management Feature Descriptor Format	168
Table 155 – Power Management Feature Commands	168
Table 156 – Power Management Feature Parameters	168
Table 157 – Embedded Changer Feature Descriptor Format	170
Table 158 – Embedded Changer Feature Command	170
Table 159 – CD Audio External Play Feature Descriptor Format	171
Table 160 – CD-Audio External Play Feature Commands	172
Table 161 – CD-Audio External Play Feature Parameters	172
Table 162 – Microcode Upgrade Feature Command	173
Table 163 – Microcode Upgrade Feature Descriptor Format	173
Table 164 – Timeout Feature Descriptor Format	174
Table 165 – Timeout Feature Parameter	174
Table 166 – DVD CSS Feature Descriptor Format	175
Table 167 – DVD CSS Feature Commands	175
Table 168 – Real Time Streaming Feature Descriptor Format	176
Table 169 – Real Time Streaming Feature Commands	177
Table 170 – Logical Unit Serial Number Feature Descriptor	178
Table 171 – Logical Unit Serial Number Feature Descriptor	179
Table 172 – Commands Required by the Media Serial Number Feature	179
Table 173 – Disc Control Blocks Feature Descriptor	180
Table 174 – Disc Control Blocks Feature Commands	180
Table 175 – DVD CPRM Feature Descriptor Format	181

Table 176 – DVD CPRM Feature Commands	181
Table 177 – Firmware Information	182
Table 178 – Mandatory Features for Non-removable Disks	185
Table 179 – Non-Removable Disk Profile Decomposition	185
Table 180 – Mandatory Features for Removable Disks	186
Table 181 – Removable Disk Profile Decomposition	186
Table 182 – Mandatory Features for Magneto-Optical Erasable	187
Table 183 – Magneto-Optical Erasable Profile Decomposition	187
Table 184 – Mandatory Features for Optical Write Once	188
Table 185 – Optical Write Once Profile Decomposition	188
Table 186 – Mandatory Features for AS-MO	189
Table 187 – AS-MO Profile Decomposition	189
Table 188 – Mandatory Features for CD-ROM	190
Table 189 – CD-ROM Profile Decomposition	190
Table 190 – Mandatory Features for CD-R	191
Table 191 – CD-R Profile Decomposition	192
Table 192 – Mandatory Features for CD-RW	193
Table 193 – CD-RW Profile Decomposition	194
Table 194 – Mandatory Features for DVD-ROM	195
Table 195 – DVD-ROM Profile Decomposition	195
Table 196 – Mandatory Features for DVD-R Sequential recording	196
Table 197 – DVD-R Sequential Recording Profile Decomposition	197
Table 198 – Mandatory Features for DVD-RAM	198
Table 199 – DVD-RAM Profile Decomposition	198
Table 200 – Mandatory Features for DVD-RW Restricted Overwrite	199
Table 201 – DVD-RW Restricted Overwrite Profile Decomposition	200
Table 202 – Mandatory Features for DVD-RW Sequential recording	201
Table 203 – DVD-RW Sequential Recording Profile Decomposition	202
Table 204 – Mandatory Features for DVD+RW	203
Table 205 – DVD+RW Profile Decomposition	204
Table 206 – Mandatory Features for DVD+R	205
Table 207 – DVD+R Profile Decomposition	206
Table 208 – Mandatory Feature List for the DDCD-ROM	207
Table 209 – DDCD-ROM Profile Decomposition	207
Table 210 – Mandatory Feature List for the DDCD-R	208
Table 211 – DDCD-R Profile Decomposition	208
Table 212 – Mandatory Feature List for the DDCD-R/RW	209
Table 213 – DDCD-RW Profile Decomposition	210
Table 214 – Mandatory Features for Logical Units Not Conforming to a Standard Profile	211
Table 215 – Commands for Multi-Media Logical Units (Alphabetic order)	212
Table 216 – Commands for Multi-Media Logical Units (Opcode order)	213
Table 217 – Features Associated with the BLANK Command	214
Table 218 – BLANK CDB	214
Table 219 – Blanking Types CD-RW and DDCD-RW	215

Table 220 – Blanking Types for DVD-RW media	216
Table 221 – Recommended errors for BLANK Command	217
Table 222 – Features Associated with the CLOSE TRACK/SESSION command.....	218
Table 223 – CLOSE TRACK/SESSION CDB	218
Table 224 – Close Function Definitions.....	219
Table 225 – Recommended errors for CLOSE TRACK/SESSION Command	222
Table 226 – Features Associated with the ERASE (10) Command.....	223
Table 227 – ERASE (10) CDB	223
Table 228 – Recommended errors for ERASE (10) Command	224
Table 229 – Features Associated with the FORMAT UNIT Command.....	225
Table 230 – FORMAT UNIT CDB	225
Table 231 – DVD-RAM Defect List Handling	226
Table 232 – Format Unit Parameter List	226
Table 233 – Format List Header.....	226
Table 234 – Initialization Pattern Descriptor.....	228
Table 235 – IP Modifier Field.....	228
Table 236 – Initialization Pattern Type	228
Table 237 – Format Code 001b Format Descriptor.....	229
Table 238 – Use of DCRT when MRW Formatting	233
Table 239 – Type Dependent Parameter for Format Type 26h	233
Table 240 – Sense Key Specific Bytes in Sense Data.....	234
Table 241 – Writing During different Format States	237
Table 242 – Recommended Errors for the FORMAT UNIT Command.....	237
Table 243 – Features Associated with the GET CONFIGURATION Command.....	238
Table 244 – GET CONFIGURATION CDB	238
Table 245 – RT Field Definitions	238
Table 246 – GET CONFIGURATION response data format.....	239
Table 247 – Feature Header	239
Table 248 – Recommended Errors for the GET CONFIGURATION Command	240
Table 249 – Features Associated with the GET EVENT STATUS NOTIFICATION Command	241
Table 250 – GET EVENT STATUS NOTIFICATION CDB.....	241
Table 251 – Notification Class Request field definition	242
Table 252 – Event Status Notification Response	242
Table 253 – Event Header.....	242
Table 254 – Notification Class Field Values.....	243
Table 255 – General Event Descriptor Format.....	243
Table 256 – Operational Change Event Descriptor.....	244
Table 257 – Event Codes For the Operational Change Class	244
Table 258 – Operational Change	244
Table 259 – Power Management Event Descriptor.....	245
Table 260 – Power Event Field	245
Table 261 – Power Status Field	245
Table 262 – External Request Descriptor	246
Table 263 – External Request Events	246

Table 264 – External Request Status Codes	246
Table 265 – External Request Codes	247
Table 266 – Media Event Descriptor	248
Table 267 – Media Event Format	248
Table 268 – Media Status Byte Definition	248
Table 269 – Multiple Initiator Descriptor	250
Table 270 – Multiple Initiator Event Format	250
Table 271 – Multiple Initiator Status Codes	250
Table 272 – Multiple Initiator Priority Codes	250
Table 273 – Device Busy Event Descriptor	251
Table 274 – Device Busy Event Codes	251
Table 275 – Device Busy Status	251
Table 276 – Recommended Errors for GET EVENT STATUS NOTIFICATION Command	253
Table 277 – Features Associated with the GET PERFORMANCE Command	254
Table 278 – GET PERFORMANCE CDB	254
Table 279 – Type Field Definitions	255
Table 280 – Performance response format	255
Table 281 – Performance Header	255
Table 282 – Data Type Field Definitions for Type = 00h	256
Table 283 – Performance Descriptor – Nominal Performance	256
Table 284 – Performance Descriptor – Exceptions	257
Table 285 – Unusable Area Type values	257
Table 286 – Unusable Area Descriptor	258
Table 287 – Defect Status Descriptor	259
Table 288 – Write Speed Descriptor	260
Table 289 – Write Rotation Control values	260
Table 290 – DBI data	261
Table 291 – DBI data Header	261
Table 292 – DBI Descriptor	261
Table 293 – Error Level Type values	262
Table 294 – Recommended errors for GET PERFORMANCE Command	263
Table 295 – Features Associated with the INQUIRY Command	264
Table 296 – INQUIRY Data for ATAPI and USB Logical Units	264
Table 297 – INQUIRY Command Errors	264
Table 298 – Features Associated with the LOAD/UNLOAD MEDIUM Command	265
Table 299 – LOAD/UNLOAD MEDIUM CDB	265
Table 300 – LoUnlo/Start Operation	265
Table 301 – LOAD/UNLOAD MEDIUM Command Errors	266
Table 302 – Features Associated with the MECHANISM STATUS Command	267
Table 303 – MECHANISM STATUS CDB	267
Table 304 – Mechanism Status Parameter List Format	268
Table 305 – Mechanism Status Header	268
Table 306 – Changer State Field	268
Table 307 – Mechanism State Field	269

Table 308 – Slot Table Format.....	269
Table 309 – Recommended errors for Mechanism Status Command	270
Table 310 – Features Associated with the Mode Select Command	271
Table 311 – Recommended errors for Mode Select (10) Command	271
Table 312 – Features Associated with the Mode Sense Command	272
Table 313 – Recommended errors for Mode Sense (10) Command	272
Table 314 – Features Associated with the PAUSE/RESUME Command.....	273
Table 315 – Pause/Resume CDB	273
Table 316 – Recommended errors for PAUSE/RESUME Command	274
Table 317 – Features Associated with the PLAY AUDIO (10) Command	275
Table 318 – PLAY AUDIO (10) CDB	275
Table 319 – Recommended errors for PLAY AUDIO (10) Command.....	276
Table 320 – Features Associated with the PLAY AUDIO (12) Command	277
Table 321 – PLAY AUDIO (12) CDB	277
Table 322 – Recommended errors for PLAY AUDIO(12) Command.....	278
Table 323 – Features Associated with the PLAY AUDIO MSF Command	279
Table 324 – PLAY AUDIO MSF CDB.....	279
Table 325 – Recommended errors for PLAY AUDIO MSF Command	280
Table 326 – Features Associated with the PREVENT ALLOW MEDIUM REMOVAL Command	281
Table 327 – PREVENT ALLOW MEDIUM REMOVAL CDB	281
Table 328 – State Selection	281
Table 329 – Actions for Lock/Unlock/Eject.....	282
Table 330 – Recommended errors for PREVENT ALLOW MEDIUM REMOVAL Command.....	283
Table 331 – Features Associated with the READ (10) Command	284
Table 332 – READ (10) CDB.....	284
Table 333 – Recommended errors for READ (10) Command	285
Table 334 – Features Associated with the READ (12) Command.....	286
Table 335 – READ (12) CDB.....	286
Table 336 – Recommended errors for READ (12) Command	288
Table 337 – Recommended errors for READ BUFFER Command	289
Table 338 – Features Associated with the READ BUFFER CAPACITY Command.....	290
Table 339 – READ BUFFER CAPACITY CDB	290
Table 340 – Buffer Capacity Structure, when Block = 0.....	291
Table 341 – Buffer Capacity Structure, when Block = 1.....	291
Table 342 – Recommended errors for READ BUFFER CAPACITY Command	292
Table 343 – Features Associated with the READ CAPACITY Command	293
Table 344 – READ CAPACITY CDB	293
Table 345 – READ CAPACITY Response Data.....	294
Table 346 – Logical Block Address Reporting	294
Table 347 – Recommended errors for READ CAPACITY Command.....	295
Table 348 – Features Associated with the READ CD Command	296
Table 349 – READ CD CDB.....	296
Table 350 – Expected Sector type field bit definitions.....	297
Table 351 – Main Channel Selection and Mapped Values	299

Table 352 – C2 Errors Codes	300
Table 353 – Sub-Channel Selection Field Values	300
Table 354 – Formatted Q- Subchannel Data	302
Table 355 – Recommended errors for READ CD Command	303
Table 356 – Features Associated with the READ CD MSF Command	304
Table 357 – READ CD MSF CDB.....	304
Table 358 – Recommended errors for READ CD MSF Command	305
Table 359 – Features Associated with the READ DISC INFORMATION Command.....	306
Table 360 – READ DISC INFORMATION CDB.....	306
Table 361 – Disc Information Block	307
Table 362 – State of Last Session	308
Table 363 – Disc Status	308
Table 364 – Background Format Status Codes.....	309
Table 365 – Disc Type Field	310
Table 366 – OPC Table Entry.....	311
Table 367 – Recommended errors for READ DISC INFORMATION Command	311
Table 368 – Features Associated with the READ DVD STRUCTURE Command	312
Table 369 – READ DVD STRUCTURE CDB.....	312
Table 370 – Format Code Definitions	313
Table 371 – READ DVD STRUCTURE Data Format (Format field = 00h)	314
Table 372 – Layer Descriptor.....	314
Table 373 – Book Type Field	315
Table 374 – Maximum Rate Field	315
Table 375 – Layer Type Field	315
Table 376 – Linear Density Field	316
Table 377 – Track Density Field	316
Table 378 – Starting Physical Sector Number of Data Area field	316
Table 379 – DVD+RW Layer Descriptor	317
Table 380 – READ DVD STRUCTURE Data Format (Format field = 01h)	318
Table 381 – READ DVD STRUCTURE Data Format (Format field = 02h)	319
Table 382 – READ DVD STRUCTURE Data Format (Format field = 03h)	320
Table 383 – READ DVD STRUCTURE Data Format (Format field = 04h)	321
Table 384 – READ DVD STRUCTURE Data Format (Format field = 05h)	322
Table 385 – CPR_MAI Field Definition	322
Table 386 – READ DVD STRUCTURE Data Format (Format Field = 06h)	324
Table 387 – READ DVD STRUCTURE Data Format (Format Field = 07h)	325
Table 388 – READ DVD STRUCTURE Data Format (Format field = 08h)	326
Table 389 – READ DVD STRUCTURE Data Format (Format = 09h).....	327
Table 390 – RAM-SWI Information field definition	328
Table 391 – READ DVD STRUCTURE Data Format (Format = 0Ah).....	329
Table 392 – READ DVD STRUCTURE Data Format (Format = 0Bh).....	330
Table 393 – READ DVD STRUCTURE Data Format (Format field = 0Ch).....	331
Table 394 – READ DVD STRUCTURE Data Format (Format field = 0Dh).....	332
Table 395 – READ DVD STRUCTURE Data Format (Format field = 0Eh).....	333

Table 396 – READ DVD STRUCTURE Data Format (Format field = 0Fh).....	334
Table 397 – READ DVD STRUCTURE Data Format (With Format field = 10h).....	335
Table 398 – ADIP Information	336
Table 399 – Generic Disc Control Block	336
Table 400 – Valid Values for Content Descriptor	336
Table 401 – Unknown Content Descriptor Actions.....	337
Table 402 – WDCB Format	337
Table 403 – Write Protect Actions Field	337
Table 404 – SDCB Format	339
Table 405 – Disc Control Block (FFFFFFFFh).....	340
Table 406 – READ DVD STRUCTURE Data Format (Format field = 31h).....	341
Table 407 – READ DVD STRUCTURE Data Format (Format field = C0h)	342
Table 408 – READ DVD STRUCTURE Data Format (Format field = FFh)	343
Table 409 – Structure List Entry.....	343
Table 410 – Recommended errors for READ DVD STRUCTURE Command.....	344
Table 411 – Features Associated with the READ FORMAT CAPACITIES Command.....	345
Table 412 – READ FORMAT CAPACITIES CDB	345
Table 413 – READ FORMAT CAPACITIES Data Format.....	346
Table 414 – Capacity List Header	346
Table 415 – Current/Maximum Capacity Descriptor	347
Table 416 – Descriptor Types	347
Table 417 – Returned Current/Maximum Descriptor for Combination of Logical Unit and Media	347
Table 418 – Formattable Capacity Descriptor Format	348
Table 419 – Format Types	349
Table 420 – Recommended errors for READ FORMAT CAPACITIES Command.....	350
Table 421 – Features Associated with the READ SUB-CHANNEL Command	351
Table 422 – READ SUB-CHANNEL CDB	351
Table 423 – Sub-channel Parameter List Codes	351
Table 424 – Read Sub-Channel Returned Data Format.....	352
Table 425 – Sub-Q Channel Data Header Format.....	352
Table 426 – Audio status codes	352
Table 427 – CD current position data format	353
Table 428 – ADR Q Sub-channel field	353
Table 429 – Q Sub-channel control field	353
Table 430 – Q Sub-channel control field for DDCCD	354
Table 431 – Media Catalog Number data format	355
Table 432 – Track International Standard Recording Code data format.....	356
Table 433 – Recommended errors for READ SUB-CHANNEL Command.....	357
Table 434 – Features Associated with the READ TOC/PMA/ATIP Command.....	358
Table 435 – READ TOC/PMA/ATIP CDB	358
Table 436 – Format Field Values	359
Table 437 – READ TOC/PMA/ATIP Data list, general definition	359
Table 438 – READ TOC/PMA/ATIP response data (Format = 0000b)	360
Table 439 – Track Start Addresses for CD-MRW Discs	361

Table 440 – Track Start Addresses for DVD+MRW Discs.....	361
Table 441 – Fabrication of TOC Form 0 for Single Session DVD	362
Table 442 – READ TOC/PMA/ATIP response data (Format = 0001b).....	363
Table 443 – Fabrication of TOC Form 1 for Single Session DVD	364
Table 444 – READ TOC/PMA/ATIP response data (Format = 0010b).....	365
Table 445 – TOC Track Descriptor Format, Q Sub-channel	366
Table 446 – DDCD TOC Track Descriptor Format, Q Sub-channel.....	367
Table 447 – POINT Field	367
Table 448 – Disc Type Byte Format	368
Table 449 – READ TOC/PMA/ATIP response data (Format = 0011b).....	369
Table 450 – READ TOC/PMA/ATIP response data (Format = 0100b).....	370
Table 451 – READ TOC/PMA/ATIP response data (With Format Field = 0101b)	373
Table 452 – Recommended errors for READ TOC/PMA/ATIP Command.....	373
Table 453 – Features Associated with the READ TRACK INFORMATION Command	374
Table 454 – READ TRACK INFORMATION CDB	374
Table 455 – LBA/Track/Session Number Field definition	375
Table 456 – Track Information Block	376
Table 457 – Track Mode Definition	377
Table 458 – RT Bit Definition	377
Table 459 – Blank Bit Definition	378
Table 460 – Packet/Inc Bit Definition	378
Table 461 – FP bit Definition.....	378
Table 462 – Write Parameter Restrictions due to Track State	379
Table 463 – Track Status Indications.....	380
Table 464 – Data Mode.....	380
Table 465 – Next Writable Address Definition	381
Table 466 – Recommended Errors for the Read Track Information Command.....	385
Table 467 – REPAIR TRACK CDB.....	386
Table 468 – Recommended errors for REPAIR TRACK Command.....	387
Table 469 – Features Associated with the REPORT KEY Command.....	388
Table 470 – REPORT KEY CDB	388
Table 471 – KEY Class Definition.....	388
Table 472 – KEY Format Code definitions for REPORT KEY Command (KEY Class 0)	389
Table 473 – REPORT KEY Data Format (With KEY Format = 000000b, Key Class = 0).....	390
Table 474 – REPORT KEY Data Format (With KEY Format = 000001b, Key Class = 0).....	390
Table 475 – REPORT KEY Data Format (With KEY Format = 000010b, Key Class = 0).....	391
Table 476 – REPORT KEY Data Format (With KEY Format = 000100b, Key Class = 0).....	391
Table 477 – REPORT KEY Data Format (With KEY Format = 000101b, Key Class = 0).....	392
Table 478 – REPORT KEY Data Format (With KEY Format = 001000b, Key Class = 0).....	393
Table 479 – Type Code Field Definitions	393
Table 480 – RPC Scheme field Definition.....	393
Table 481 – REPORT KEY Data Format (With Key Format = 010001b, Key Class = 0).....	394
Table 482 – Recommended errors for REPORT KEY Command.....	394
Table 483 – Features Associated with the REQUEST SENSE Command	395

Table 484 – Recommended errors for REQUEST SENSE Command	395
Table 485 – Features Associated with the RESERVE TRACK Command	396
Table 486 – RESERVE TRACK CDB	396
Table 487 – Track Reservation on CD-R/-RW Media	397
Table 488 – Track Reservation on DVD-R/-RW Media	397
Table 489 – Recommended errors for RESERVE TRACK Command	398
Table 490 – Features Associated with the SCAN Command	399
Table 491 – SCAN CDB	399
Table 492 – Type Field Bit Definitions	400
Table 493 – Recommended errors for SCAN Command	400
Table 494 – Features Associated with the SEEK (10) Command	401
Table 495 – SEEK (10) CDB	401
Table 496 – Recommended errors for SEEK (10) Command	402
Table 497 – Features Associated with the SEND CUE SHEET Command	403
Table 498 – SEND CUE SHEET CDB	403
Table 499 – Cue Sheet format	404
Table 500 – Sample CUE SHEET	404
Table 501 – Cue Sheet Data	405
Table 502 – CTL/ADR byte	405
Table 503 – Control Field	405
Table 504 – ADR Field	406
Table 505 – Data Form Byte	406
Table 506 – SCMS Byte	406
Table 507 – CD (CD-DA)	407
Table 508 – CD-DA Data format (1 Sample)	407
Table 509 – CD-ROM mode 1	407
Table 510 – CD-ROM XA, CD-I	408
Table 511 – CD-ROM Mode 2	408
Table 512 – Data Form of Sub-channel	409
Table 513 – Media Catalog Number (N1..N13)	410
Table 514 – ISRC (I1..I12)	411
Table 515 – Recommended errors for SEND CUE SHEET Command	411
Table 516 – Features Associated with the SEND DVD STRUCTURE Command	412
Table 517 – SEND DVD STRUCTURE CDB	412
Table 518 – Format Field Definition	413
Table 519 – SEND DVD STRUCTURE Data Format (Format Code = 04h)	413
Table 520 – SEND DVD STRUCTURE Data Format (Format Code = 05h)	414
Table 521 – CPR_MAI Field Definitions	414
Table 522 – CGMS Field Values	415
Table 523 – SEND DVD STRUCTURE Data Format (Format Code = 0Fh)	416
Table 524 – SEND DVD STRUCTURE Data Format (Format field = 30h)	417
Table 525 – WDCB Management Examples	418
Table 526 – SEND DVD STRUCTURE Data Format (Format Field = C0h)	419
Table 527 – Recommended errors for SEND DVD STRUCTURE Command	419

Table 528 – Features Associated with the SEND KEY Command.....	420
Table 529 – SEND KEY CDB	420
Table 530 – Key Class	420
Table 531 – Key Format Code definitions for SEND KEY Command	421
Table 532 – SEND KEY Parameter List (KEY Format field =000001b)	421
Table 533 – SEND KEY Parameter List (KEY Format field =000011b)	422
Table 534 – SEND KEY Parameter List (KEY Format field =000110b)	423
Table 535 – Recommended errors for SEND KEY Command.....	423
Table 536 – Features Associated with the SEND OPC INFORMATION Command.....	424
Table 537 – SEND OPC INFORMATION CDB	424
Table 538 – SEND OPC INFORMATION Parameter List	425
Table 539 – Recommended errors for SEND OPC INFORMATION Command.....	425
Table 540 – Features Associated with the SET CD SPEED Command	426
Table 541 – SET CD SPEED CDB	426
Table 542 – Rotational Control Parameter	426
Table 543 – Recommended errors for SET CD SPEED Command.....	427
Table 544 – Features Associated with the SET READ AHEAD Command	428
Table 545 – SET READ AHEAD CDB	428
Table 546 – Logical Init Reactions to SET READ AHEAD Command.....	429
Table 547 – Recommended errors for SET READ AHEAD Command.....	429
Table 548 – Features Associated with the SET STREAMING Command	430
Table 549 – SET STREAMING CDB	430
Table 550 – Type field definition	430
Table 551 – Performance Descriptor	431
Table 552 – DBI cache zone Descriptor	432
Table 553 – DBI cache zone Header.....	432
Table 554 – DBI cache zone Descriptor(s).....	433
Table 555 – Recommended errors for SET STREAMING Command.....	433
Table 556 – Features Associated with the START STOP UNIT Command.....	434
Table 557 – START STOP UNIT CDB	434
Table 558 – Power Conditions	434
Table 559 – LoEj and Start Meanings when Power Conditions = 0	435
Table 560 – Recommended errors for START STOP UNIT Command	435
Table 561 – Features Associated with the STOP PLAY/SCAN Command.....	436
Table 562 – STOP PLAY/SCAN CDB	436
Table 563 – Recommended errors for STOP PLAY/SCAN Command	437
Table 564 – Features Associated with the SYNCHRONIZE CACHE Command.....	438
Table 565 – SYNCHRONIZE CACHE CDB.....	438
Table 566 – Recommended errors for SYNCHRONIZE CACHE Command	439
Table 567 – Features Associated with the TEST UNIT READY Command.....	440
Table 568 – Recommended errors for TEST UNIT READY Command	440
Table 569 – Features Associated with the VERIFY (10) Command	441
Table 570 – VERIFY (10) CDB	441
Table 571 – Recommended errors for VERIFY (10) Command.....	442

Table 572 – Features Associated with the WRITE (10) Command	443
Table 573 – WRITE (10) CDB	443
Table 574 – LBA to MSF translation	445
Table 575 – Recommended errors for WRITE (10) Command.....	447
Table 576 – Features Associated with the WRITE (12) Command	448
Table 577 – WRITE (12) CDB	448
Table 578 – Recommended errors for WRITE (12) Command.....	450
Table 579 – Features Associated with the WRITE AND VERIFY (10) Command.....	451
Table 580 – WRITE AND VERIFY (10) CDB	451
Table 581 – Recommended errors for WRITE AND VERIFY (10) Command.....	452
Table 582 – Features Associated with the WRITE BUFFER Command	453
Table 583 – WRITE BUFFER Command Errors	453
Table 584 – Mode Parameter List	454
Table 585 – Mode Parameters Header	454
Table 586 – Mode Pages for MM Logical Units	455
Table 587 – Mode Page Format.....	455
Table 588 – Features Associated with the READ/WRITE Error Recovery Mode Page.....	457
Table 589 – Read/Write Error Recovery Parameters Mode Page Format.....	457
Table 590 – CD-ROM Devices, error recovery description	459
Table 591 – DVD Devices, Error Recovery Description.....	462
Table 592 – Relationship of PER and EMCDCR when Enhanced Defect Reporting Feature is current	463
Table 593 – Features Associated with the MRW Mode Page.....	464
Table 594 – MRW Mode Page	464
Table 595 – Features Associated with the Write Parameters Mode Page	465
Table 596 – Write Parameters Page	466
Table 597 – Use of BUFE bit.....	467
Table 598 – Write Type Field	467
Table 599 – Multi-session Field Definition.....	468
Table 600 – Data Block Type Codes.....	469
Table 601 – Session Format Codes	470
Table 602 – Media Catalog Number Format.....	470
Table 603 – International Standard Recording Code Format	471
Table 604 – Caching mode page Format.....	472
Table 605 – Features Associated with the CD Audio Control Page.....	473
Table 606 – CD Audio Control Page Format.....	473
Table 607 – CDDA Output Port Channel Selection Codes	474
Table 608 – Attenuation Levels for Audio	474
Table 609 – Features Associated with the Power Condition mode page	475
Table 610 – Features Associated with the Informational Exceptions Control mode page.....	476
Table 611 – Features Associated with the Timeout and Protect Page	477
Table 612 – Timeout & Protect Page	477
Table A.1 – ATAPI Command Packet containing a 6-Byte CDB	481
Table A.2 – ATAPI Command Packet containing a 10-Byte CDB	481
Table A.3 – ATAPI Command Packet containing a 12-Byte CDB	482

Table A.4 – Example Reset Function Mapping in ATAPI	482
Table B.1 – Example Reset Function Mapping in SCSI	485
Figure C.1 – Mass storage interface block diagram	487
Table D.1 – Bulk-Only Mass Storage Reset	494
Table D.2 – Get Max LUN	495
Table D.3 – Device Descriptor	496
Table D.4 – Configuration Descriptor	497
Table D.5 – Bulk-Only Data Interface Descriptor	498
Table D.6 – Bulk-In Endpoint Descriptor	498
Table D.7 – Bulk-Out Endpoint Descriptor	499
Table D.8 – Command Block Wrapper	500
Table D.9 – Command Status Wrapper	501
Table D.10 – Command Block Status Values	502
Table E.1 – Operational Change Event Descriptor	504
Table E.2 – Event Codes For the Operational Change Class	504
Table E.3 – Operational Status	505
Table E.4 – Operational Change	505
Table E.5 – Device Busy Event Descriptor	505
Table E.6 – Device Busy Event Format	505
Table E.7 – Device Busy Status Format	506
Table E.8 – CD-RW Format Descriptor	506
Table E.9 – READ TOC/PMA/ATIP CDB - Legacy Version	507
Table E.10 – Format Field Values	508
Table E.11 – Features Associated with the SEND EVENT Command	508
Table E.12 – SEND EVENT CDB	508
Table E.13 – Event Parameter Header	509
Table E.14 – Operational Change/Notification Parameter Data	509
Table E.15 – Operational Event Field	509
Table E.16 – Recommended errors for SEND EVENT Command	510
Table E.17 – Block Descriptor Block Sizes for Read	511
Table E.18 – CD Parameters page	512
Table E.19 – Inactivity timer multiplier values	512
Table E.20 – MM Capabilities and Mechanical Status Page	513
Table E.21 – Loading Mechanism Type	515
Table E.22 – Bit Length of IEC958 Words	516
Table E.23 – Logical Unit Write Speed Performance Descriptor Table Format	517
Table E.24 – Rotation Control Selected field definition	517
Table F.1 – Unit Attention Conditions	519
Table F.2 – CDB or Parameter Validation Errors	520
Table F.3 – Readiness Errors	520
Table F.4 – Protocol Errors	521
Table F.5 – General Media Access Errors	522
Table F.6 – Errors Associated with Reading	523
Table F.7 – Errors Associated with Writing	524

Table F.8 – Hardware Failures	525
Table F.9 – Errors Associated with non-ATAPI Environments.....	526
Table F.10 – Logical Unit Sense Key, ASC and ASCQ Assignments.....	527
Table I.1 – Power Management Model States	538
Table I.2 – State Transition Events and Status	542
Table I.3 – Effects of Initiator Commands on Timers	543
Table I.4 – Effects of Initiator Commands on Timers (cont.).....	544
Table J.1 - GAA Addressing on CD-MRW	547
Table J.2 - DMA Addressing on CD-MRW	547
Table J.1 – MRW Example: Significant Addresses	548
Table J.2 – MRW Example: Read Capacity Results	548
Table J.3 – MRW Example: Disc Information.....	549
Table J.4 – MRW Example: Track Information.....	550
Table J.5 – MRW Example: Form 0 TOC (SCSI-2 TOC).....	551
Table J.6 – MRW Example: Form 1 TOC (Multi-Session).....	552
Table J.7 – MRW Example: Form 2 TOC (Full TOC).....	553
Table J.8 – MRW Example: Form 2 TOC (Full TOC), continued	554
Table J.9 – MRW Example: Form 2 TOC (Full TOC), continued	555
Table J.10 – MRW: Legacy Combinations	556
Table J.11 – DVD+MRW Format Lay-out.....	561

Figures

Figure 1 – General Media Structure.....	23
Figure 2 – Disc, Session and Logical Track Decomposition.....	25
Figure 3 – Adjustment of Command Termination Time on Different Media	34
Figure 4 – Single Session disc.....	39
Figure 5 – Multi-Session Recorded Disc.....	39
Figure 6 – Q Sub-channel Mode-1 Format recorded in Program Area	41
Figure 7 – Q Sub-channel Mode-2 Format	41
Figure 8 – Q Sub-channel, Mode-3 Format	42
Figure 9 – Q Sub-channel Mode-1 Format recorded in Lead-in	43
Figure 10 – Q Sub-channel Mode-5 Format recorded in Lead-in	44
Figure 11 – Synchronization Field pattern	45
Figure 12 – ATIP Data	48
Figure 13 – Time Codes in CD-R and CD-RW Pre-groove	50
Figure 14 – CD-R Volume 1 and CD-RW Structure	51
Figure 15 – CD-R Volume 2 Structure.....	52
Figure 16 – PMA, Q Sub-channel	52
Figure 17 – Packet Format.....	53
Figure 18 – Physical and Logical Layout of DDCD-ROM/R/RW	60
Figure 19 – Multi-Session Recorded Disc.....	61
Figure 20 – Sector format Mode 2	61
Figure 21 – Sub-code-Q Mode1 format recorded in Program Area.....	62
Figure 22 – Packet Layout	65
Figure 23 – Example of Packet written Track layout	65
Figure 24 – The Zones of a DVD Medium	66
Figure 25 – Single Layer, Single Sided Disc.....	67
Figure 26 – Parallel Track Path Disc	67
Figure 27 – Opposite Track Path Disc.....	68
Figure 28 – Logical Layout of a DVD Data Sector	68
Figure 29 – ID Field.....	68
Figure 30 – ECC Block Structure	69
Figure 31 – General Layout of Lead-in Area.....	70
Figure 32 – ID Field for DVD-ROM	72
Figure 33 – ID Field for DVD-RAM	74
Figure 34 – ID Field for DVD-R/-RW.....	77
Figure 35 – Structure of Extra Border Zone.....	81
Figure 36 – DVD+R ID Field Details	83
Figure 37 – General Layout of a Multi-Session DVD+R	86
Figure 38 – ID Field for DVD+RW.....	90
Figure 39 – General Structure of MRW Candidate Media	94
Figure 40 – Main Areas Defined by MRW	94
Figure 41 –Example of DBI memory blocks.....	102
Figure 42 –Example of defect level transition	106
Figure 43 – Example of Data Allocation in case of Linear Replacement.....	111

Figure 44 – An example of data allocation on the Stream recording operation 111

Figure 45 – Media Changer Mechanism Model 117

Figure 46 – Changer State Diagram..... 119

Figure 47 – Background Process Flow 236

Figure 48 – Execution of a command that may cause Logical Unit Busy 252

Figure 49 – Location of Sub-channel Data..... 409

Figure 50 – Stop Play/Play Audio/Audio Scan/Pause/Resume Sequencing 437

Figure I.1 – Power Management STATE Diagram..... 540

Figure J.1 - Track/Session Structure of a MRW Disc..... 546

Figure J.2 - The Additional Structure..... 546

Figure J.3 – MRW Mapping onto DVD+RW, General 560

**This page is intentionally
blank.**

Forward

(This forward is not part of American National Standard INCITS ***-****.)

This standard defines the command set to access multimedia Features for all classes of SCSI devices. The applicable clauses of this standard when used in conjunction with SCSI Primary Commands and other applicable command set documents pertaining to the subject device class, define the full standard set of commands available for that device in a SCSI environment.

Requests for interpretation, suggestions for improvement and addenda, or defect reports are welcome. They should be sent to the INCITS Secretariat, Information Technology Industry Council, 1250 I Street NW, Suite 200, Washington, DC 20005-3922.

This standard was processed and approved for submittal to ANSI by National Committee for Information Technology Standards (INCITS). Committee approval of this standard does not necessarily imply that all committee members voted for approval. At the time it approved this standard, INCITS had the following members:

To be supplied prior to forwarding to INCITS, Chair

To be supplied prior to forwarding to INCITS, Vice-Chair

To be supplied prior to forwarding to INCITS, Secretary

Organization Represented..... Name of Representative

Entire list to be supplied prior to forwarding to INCITS

Technical Committee T10 on Lower Level Interfaces, that developed and reviewed this standard, had the following members:

John B. Lohmeyer, Chair
George O. Penokie, Vice-Chair
Ralph O. Weber, Secretary

Entire list to be supplied prior to forwarding to INCITS.

Multimedia Command Set – 4 (MMC-4)

1 Scope

This standard defines a set of SCSI command descriptor blocks that are useful in accessing and controlling devices with a peripheral device type set to 5.

This command set is transport independent and may be implemented across a wide variety of environments for which a SCSI transport protocol has been defined. To date, these include Parallel SCSI, ATA/ATAPI, Serial ATA, Universal Serial Bus (USB versions 1.1 and 2.0), and High Performance Serial Bus (IEEE 1394, 1394A, and 1394B).

The command set described has been selected for correct operation when the physical interface is ATA with the ATAPI command protocol. Although some commands are also described in the SPC-3 the descriptions are also in this standard for the purpose of profiling mandatory and optional command features as applied to multi-media devices.

The objective of this command set is to provide for the following:

- A definition of the command formats and functions independent of delivery, protocol/signaling or transport mechanism. Architectural constraints regarding command functions, over the various transports, are addressed in the document specific to the physical transport.
- Standardized access to common features of devices employed in multimedia applications.
- System software/firmware independence across device classes and physical interfaces. Provision is made for the addition of special features and functions through the use of vendor-specific options.
- To provide compatibility such that properly conforming devices may inter-operate with subsequent devices.

**This page is intentionally
blank.**

2 References

2.1 Normative References

The following standards contain provisions that, through reference in the text, constitute provisions of this standard. At the time of publication, the editions indicated were valid. All standards are subject to revision and parties to agreements based on this standard are encouraged to investigate the possibility of applying the most recent editions of the standards listed below.

Copies of the following documents may be obtained from ANSI:

- a) approved and draft ANSI standards;
- b) approved and draft international and regional standards (ISO, IEC, CEN/CENELEC, ITUT);
- c) approved and draft foreign standards (including BSI, JIS, and DIN).

For further information contact ANSI Customer Service Department at 212-642-4900 (phone), 212-302-1286 (fax) or via the World Wide Web at <http://www.ansi.org>.

Additional availability contact information is provided below as needed.

2.2 Approved References

The following are approved ANSI, approved international and approved regional publications (ISO, IEC, CEN/CENELEC, and ITUT), and may be obtained from the international and regional organizations that control them.

ANSI NCITS.336:2000	SCSI Parallel Interface 3 (SPI-3)
ANSI NCITS.351:2001	SCSI-3 Primary Commands (SPC-2)
ANSI INCITS 360:2002	SCSI-3 MultiMedia Command Set 3 (MMC-3)
ANSI NCITS.306:1998	SCSI-3 Block Command Set (SBC)
ANSI NCITS.325:1998	SCSI Serial Bus Protocol – 2 (SBP-2)
ANSI NCITS.361:2002	ATA Attachment with Packet Interface 6 (ATA/ATAPI-6)
ISO/IEC 3901:2001	International Standard Recording Code (ISRC)
ISO/IEC 10149:1995	Information Technology-Data Interchange on Read-only 120 mm Optical Data Discs (CD-ROM).
ISO/IEC 16448:2002	Information technology -- 120 mm DVD -- Read-only disk
ISO/IEC 16449:2002	Information technology - 80 mm DVD - Read-only disk
ISO/IEC 16824:1999	Information technology -- 120 mm DVD rewritable disk
ECMA 167, 3 rd Edition	Volume and File Structure for Write-Once and Rewritable Media using Non-Sequential Recording for Information Interchange
ECMA 330	120 mm (4,7 Gbytes per side) and 80 mm (1,46 Gbytes per side) DVD Rewritable Disk (DVD-RAM)
ECMA 337	120 mm 4,7GB and 80 mm 1,46 GB DVD ReWritable Disc (DVD+RW)
ECMA 338	80 mm (1,46 Gbytes per side) and 120 mm (4,70 Gbytes per side) DVD Re-recordable Disk (DVD-RW)
IEC 908:1987	Compact Disc Digital Audio System.
ANSI/IEEE Std 1394A-2000	High Performance Serial Bus

Members of IEC and ISO maintain registers of currently valid International Standards.

2.3 References Under Development

At the time of publication, the following referenced standards were still under development. For information on the current status of the document, or regarding availability, contact the relevant standards body or other organization as indicated.

INCITS T10/1416D	SCSI Primary Command Set – 3 (SPC-3)
INCITS T10/1417D	SCSI Block Command Set – 2 (SBC-2)
INCITS T10/1467D	SCSI Serial Bus Protocol – 3 (SBP-3)
INCITS T13/1532D	ATA Attachment with Packet Interface 7 (ATA/ATAPI-7)

For more information on the current status of the above documents, contact INCITS Secretariat, 1250 Eye Street, NW Suite 200, Washington, DC 20005, Phone Number (202) 737-8888. To obtain copies of these documents, contact Global Engineering at (303) 792-2181 or INCITS Secretariat.

2.4 Other References

The following are published by the NV Philips and Sony Corporation and are available from Philips Electronics NV (for availability, consult www.licensing.philips.com):

- System Description Compact Disc Digital Audio (aka "Red Book"), See also IEC 908:1987, Compact Disc Digital Audio System
- Compact Disc Read Only Memory (aka "Yellow Book"), See also ISO/IEC 10149, Information Technology-Data Interchange on Read-only 120 mm Optical Data Discs (CD-ROM)
- CD-I Full Functional Specification ("Green Book")
- System Description Compact Disc Read Only Memory eXtended Architecture (CD-ROM XA)
- Multi-session Compact Disc Specification
- System Description Recordable Compact Disc Systems, part II: CD-R
- System Description Recordable Compact Disc Systems, part II: CD-R, Volume 2: Multi-Speed
- System Description Recordable Compact Disc Systems, part III: Compact Disc ReWritable (CD-RW)
- System Description Recordable Compact Disc Systems, part III Volume 2: CD-RW

The following are published by the DVD Forum (for availability, consult www.dvdforum.org):

- DVD Specification for Read only Disc part one Physical Specifications
- DVD Specification for Read only Disc part two File system specifications
- DVD Specification for Read only Disc part three Video Specifications
- DVD Specification for Read only Disc part four Audio Specifications
- DVD Specification for Recordable Disc part one Physical Specifications
- DVD Specification for Recordable Disc part two File system specifications
- DVD Specifications for Recordable Disc for Authoring Part one Physical Specifications
- DVD Specifications for Recordable Disc for Authoring Part two File system Specifications
- DVD Specifications for Recordable Disc for General Part one Physical Specifications
- DVD Specifications for Recordable Disc for General Part two File system Specifications
- DVD Specification for Rewritable Disc part one Physical Specifications
- DVD Specification for Rewritable Disc part two File system specifications
- DVD Specification for Re-recordable Disc (DVD-RW) part one Physical specifications
- DVD Specification for Re-recordable Disc (DVD-RW) part two File system specifications
- DVD Specification for Rewritable/Re-recordable Discs part three Video Recording

The following are published by the DVD+RW Alliance (for availability, consult www.licensing.philips.com):

- DVD+RW 4,7 Gbytes Basic Formats Specifications, Revision 1.2, December 2002
- DVD+R 4,7 Gbytes Basic Formats Specifications, Revision 1.11, December 2002
- CD-MRW Defect Management & Physical Formatting Revision 1.1, August 2001
- DVD+MRW Defect Management & Physical Formatting, Revision 1.1, October 2002

The following are published by the Small Form Factor Industry Group (SFF) (for availability, consult www.sffcommittee.org):

- Mt. Fuji5 Commands for Multi-Media devices, Version 1.6, March 2004

The following are published by the Optical Storage Technology Association (OSTA) (for availability, consult www.osta.org):

- Universal Disk Format (UDF), Revision 1.02, November 1995
- Universal Disk Format (UDF), Revision 1.5, February 1997
- Universal Disk Format (UDF), Revision 2.00, April 1998
- Universal Disk Format (UDF), Revision 2.01, March 2000
- Universal Disk Format (UDF), Revision 2.5, April 2003

NOTE 1: Some specific applications have standardized on older versions of the UDF for disc production. It may be useful to have all versions available.

The following are published by the USB Implementers Forum (for availability, consult www.usb.org):

- Universal Serial Bus Specification, Revision 2.0, published by USB Implementers Forum
- Universal Serial Bus Mass Storage Class Bulk-Only Transport, published by USB Implementers Forum

The following are published by the 4C Content Protection Working Group and are available from CPRM-licensing@4Centity.com:

- Content Protection for Recordable Media Specification: Intel, IBM, Matsushita, Toshiba 2000,

**This page is intentionally
blank.**

3 Definitions, Symbols, Abbreviations, and Conventions

3.1 Definitions

3.1.1 ADIP (Address In Pre-groove)

Address and recording information encoded in the wobble pre-groove on DVD+RW and DVD+R media is named the Address in pre-groove (ADIP).

3.1.2 AGID (Authentication Grant ID)

The Authentication Grant ID is a value used for resource control during key management. Individual key management threads are identified through the use of AGID.

3.1.3 Appendable disc

A disc with a pointer, in the last session, that points to the next possible session.

3.1.4 ASC (Additional Sense Code)

Specifically, this refers to the value stored in byte 12 of the sense information as defined in SPC-3. In the case of this standard, ASC is part of a 2-byte code: ASC/ASCQ that identifies a specific error or condition.

3.1.5 ASCQ (Additional Sense Code Qualifier)

Specifically, this refers to the value stored in byte 13 of the sense information as defined in SPC-3. In the case of this standard, ASCQ is part of a 2-byte code: ASC/ASCQ that identifies a specific error or condition.

3.1.6 ATA (AT Attachment)

ATA defines the physical, electrical, transport, and command protocols for the internal attachment of block storage devices. AT Attachment with Packet Interface 7 (ATA/ATAPI-7)

3.1.7 ATAPI (AT Attachment Packet Interface)

A device that implements the Packet command Feature set as defined in AT Attachment with Packet Interface 7 (ATA/ATAPI-7) is referred to as an ATAPI device or a device with the ATAPI.

3.1.8 ATIP (Absolute Time In Pre-groove)

Address and recording information encoded in the wobble groove on CD-R and CD-RW media is named the Absolute time in pre-groove.

3.1.9 BCA (Burst Cutting Area)

The Burst Cutting Area provides a unique physical identification mark for individual DVD medium. This area is not directly addressable by the user.

3.1.10 BCD (Binary Coded Decimal)

In this numerical representation, a byte contains two four-bit values each with a value from 0 to 9. The high order decimal digit occupies bits 7 through 4 of the byte, while the low order decimal digit occupies the bits 3 through 0 of the byte. Only non-negative values may be represented. The maximum value is 99bcd (99 decimal). Time addressing, track numbering and other information is BCD encoded at the physical format level on CD and DDCD media.

3.1.11 Background (BG)

MRW and DVD+RW formatting occur in background time. i.e., the logical unit shall permit other media accesses during the formatting process. In this standard, background refers to this process.

3.1.12 Bordered Area

A Bordered Area is a recorded area on DVD-R/-RW media that has the equivalent purpose as a session (see 3.1.124) on CD-R/-RW media.

3.1.13 BSGA

Block Sync Guard Area

3.1.14 C1, C2, C3

There are potentially 3 layers of error correction on CD media. CIRC contains two layers known as C1 and C2. C2 is layered on C1. When a sector is encoded as either mode 1 data or mode 2, form 1 data, there is a third layer of correction named C3.

3.1.15 CDB (Command Descriptor Block)

The structure of 6, 10, or 12 bytes used to communicate commands from an Initiator to a MM Logical Unit.

3.1.16 CD (Compact Disc)

CD is a family of related optical storage media.

3.1.17 CD-DA (Compact Disc-Digital Audio)

The disc format for storing digital audio information on CD is referred to as CD-DA. See IEC 908:1987.

3.1.18 CD-R (CD Recordable)

A CD that is able to be written only once is named CD-R.

3.1.19 CD-ROM (Compact Disc – Read Only Memory)

CD-ROM is used to describe media with digital data rather than discs that encode audio only.

3.1.20 CD-R/RW

This designates CD-R, CD-RW, or both.

3.1.21 CD-RW (CD ReWritable)

A CD that is able to be re-written is named CD-RW.

3.1.22 CD-Text

A method for storing text information in the lead-in and data areas of a CD-DA disc is named CD-Text.

3.1.23 Challenge key

The challenge key is data used during an authentication key exchange process.

3.1.24 Command Packet

Some transports package a SCSI CDB in a fixed size data structure that is used by the transport to communicate commands from an Initiator to a Logical Unit. This structure is named a command packet.

3.1.25 Complete (Closed) session

A session that contains a completely written Lead-in, Data area, and Lead-out is named complete. In DVD-R a complete session contains a completed Border-In, and a Border-out. It may or may not be possible to append an additional session (see Finalized Disc).

3.1.26 control field

The control field is a 4-bit field in the Q Sub-channel data on CD media indicating the type of information encoded on the current track. The information includes: audio/data, the type of audio encoding, etc.

3.1.27 CPPM (Content Protection for Prerecorded Media)

CPPM is a system for protecting DVD-Audio content on DVD-ROM media

3.1.28 CPRM (Content Protection for Recordable Media)

CPRM is a system for protecting audio-visual content on recordable DVD media

3.1.29 CIRC (Cross Interleaved Reed-Solomon Code)

The error detection and correction technique used on all CD formats is CIRC. This is sometimes referred to as correction layer 1 (C1) and correction layer 2 (C2).

3.1.30 CSS (Content Scrambling System)

CSS is an encryption system for content protection of DVD-ROM mastered for video applications.

3.1.31 DA (MRW Data Area)

On a MRW disc a DA is one of many primary zones of the disc where user data is stored. With the exception of the last DA, each DA contains the same number of sectors. The last DA contains only the remaining undedicated sectors prior to the space reserved for the STA.

3.1.32 data mode

One byte of the header of a CD data sector contains the data mode. This indicates if data is present and if layered error correction information is present. It is also applicable to DDCCD data sectors.

3.1.33 DBI (Defective Block Information)

A Logical Unit that provides Enhanced Defect Reporting for Software Defect Management maintains status of defective blocks in this area of its buffer space.

3.1.34 DDCCD (Double Density Compact Disc)

DDCCD refers to a family of related optical storage media with twice the density of CD media.

3.1.35 DDCCD-R (DDCCD Recordable)

DDCCD-R is DDCCD media that is able to be written only once.

3.1.36 DDCCD-ROM (Double Density Compact Disc – Read Only Memory)

DDCCD-ROM is a standard for storing digital data on read-only media.

3.1.37 DDCCD R/RW

This designates DDCCD-R, DDCCD-RW, or both.

3.1.38 DDCCD-RW (DDCCD ReWritable)

DDCCD-RW is DDCCD media that is able to be re-written.

3.1.39 Defect Management

Block addressable storage medium may have defects that render some sectors either temporarily or permanently unusable. A storage logical unit may implement a mechanism that provides an apparently defect free address space to the Initiator. This mechanism is named Defect Management.

3.1.40 De-Icing

When an ECC block on a DVD-RW or DVD+RW medium is blank, no headers are present in any sector of the ECC block. This means that it is not possible to locate any sector within that ECC block. This has been described as similar to sliding on ice until crashing into a written area. The process of insuring that each ECC block is written at least once to insure the presence of headers is called De-Icing.

Most read-only CD devices locate the groove only by the presence of data. When no data is present, a seek is unable to find a stopping point. Consequently, this is like having the device actuator slide on ice. Writing the entire surface (formatting) of a CD-RW disc is also referred to de-icing.

3.1.41 Direct-overwrite

The process or capability of writing over previously written data without an erase cycle is direct-overwrite.

3.1.42 Disc Key

The Disc Key is a value used during the scrambling process of the title key data on DVD media.

3.1.43 DMA (Defect Managed Area)

A MRW disc contains a logical address space that is completely covered by the defect management system of the MRW format. This logical address space is the Defect Managed Area (DMA). The primary storage space of the DMA is the collection of Das while the replacements for defective sectors from the DA collection comes from the collection of Sas.

3.1.44 Double Sided

A medium with two independently addressed sides is named double sided.

3.1.45 Dual Layer

If it is possible to access two separate DVD tracks from one side of the media, the recording is named dual layer. Dual layer Discs are recorded either OTP or PTP.

3.1.46 DVD

DVD is a family of related optical storage media and Logical Units.

3.1.47 DVD Control Data Zone

The DVD Control data zone is comprised of 192 ECC blocks in the Lead-in Area of a DVD medium. The content of 16 sectors in each block is repeated 192 times. This area contains information concerning the disc.

3.1.48 DVD Disc Manufacturing Information

The DVD Disc Manufacturing Information is recorded in the DVD Control Data Zone and contains information supplied by the disc manufacturer.

3.1.49 DVD ECC-Block

The DVD ECC block packs 16 data sectors and then applies a 2 layer error correction.

3.1.50 DVD+R (DVD plus Recordable)

DVD+R is a wobble groove based DVD medium that is write-once.

3.1.51 DVD-R (DVD Recordable)

DVD-R is a wobble groove based DVD medium that is write-once.

3.1.52 DVD-RAM (DVD-Random Access Memory)

DVD-RAM is a stamped header based DVD medium that is rewritable.

3.1.53 DVD-ROM (DVD-Read Only Memory)

DVD-ROM is a standard for recording digital data, including digital video movie data.

3.1.54 DVD+RW (DVD ReWritable)

DVD+RW is a wobble groove based DVD media that is rewritable.

3.1.55 DVD-RW (DVD Re-recordable)

DVD-RW is a wobble groove based DVD media that is rewritable.

3.1.56 DVD-Video

DVD-Video is a special case logical formatting of a DVD-ROM disc that is mastered for video applications.

3.1.57 EAN (European Article Number)

EAN is a standard number registering system for CD media, controlled by the EAN International located at 145 rue Royale B, 1000 Brussels, Belgium. See MCN.

3.1.58 ECC (Error Correction Code)

ECC is a general term for any encoding that has the purpose of detecting and correcting errors.

3.1.59 EDC (Error Detection Code)

EDC is a general term for any encoding that has the purpose of detecting data errors.

3.1.60 EFM (Eight bit to Fourteen bit Modulation code)

EFM is the modulation code used in all CD recording. EFM-plus, a modified version of EFM, is the modulation coding used in all DVD recording.

3.1.61 Feature

A feature is an atomic unit of Logical Unit functionality. A feature associated with a given Logical Unit defines only a small subset of related functionality normally associated with that Logical Unit.

3.1.62 Field

A Field is a group of two or more contiguous bits. Fields containing only one bit are referred to as the "named" bit instead of the "named" field.

3.1.63 Finalized Disc

A disc is finalized when the last session is closed with no possibility of appending a new session.

3.1.64 Fixed Packet Track

A fixed packet track is a CD track that contains only fixed length packets in its data area.

3.1.65 Format

As a noun, "format" refers to a well-defined arrangement or layout of information on a medium. Within the confines of the MMC, the verb "format" refers to process started by the FORMAT UNIT command and applies only to Rewritable media.

3.1.66 Frame

A CD frame is a physical CD sector. The F field unit of a MSF CD address is the frame field. For the Initiator, this is the smallest addressable unit on CD media.

3.1.67 Fragment

Fragment refers to a logical track on DVD+R media. See Logical Track.

3.1.68 GAA (General Application Area)

When a disc is formatted as a MRW disc, the GAA is a separately addressed LBA space. The GAA contains the first 2 MB of user data storage in the program area. This area is not covered by any MRW defect management mechanism. The GAA is defined as a legacy link for CD devices that always view LBA = 0 as being assigned to 00:02:00.

3.1.69 Hex

Hex is an abbreviation for the word hexadecimal. This indicates a binary value represented in base 16. The value may extend across multiple bytes.

3.1.70 HMSF address (Hour/Minute/Second/Frame)

HMSF is the physical addressing for CD (H is always zero) and DDCD. As defined by the CD standards, each F field unit is one sector; each S field unit is 75 F field units; each M field unit is 60 S field units. Valid contents of F fields are binary values from 0 through 74. Valid contents of S fields are binary values from 0 through 59. Valid contents of M fields are binary values from 0 through 60. Valid contents of H fields are binary values from 0 through 2.

3.1.71 Hold Track State

When a MM device enters the hold Track State the optical pick-up is maintained at an approximately constant radial position on the media.

3.1.72 ID (Identification Data)

The ID field of a DVD sector is a 4-byte field that contains sector information and a physical sector number.

3.1.73 IED (ID Error Detection)

The IED is an EDC for the ID field in a DVD sector.

3.1.74 Incomplete session

A session in which the Lead-in and Lead-out are unwritten is incomplete.

3.1.75 Incremental Recording

Incremental recording on CD is any recording that requires a linkage sequence in the data stream. Packet, Track-At-Once (TAO), and Session-At-Once (SAO) recording are all incremental.

Incremental recording is also used as a track relative term. TAO tracks are recorded uninterrupted, whereas tracks recorded in packets are recorded incrementally. This is reflected in the CONTROL field of mode 1 Q sub-channel.

3.1.76 Index

CD-DA discs may have sub-divisions of tracks identified by an index that varies from 00bcd through 99bcd. The index is recorded in the Q sub-channel of each sector of the track.

3.1.77 Layer

The recorded information is in layers as seen from one side of a DVD Disc. There are single and dual layer Discs.

3.1.78 Lead-in

On CD media the Lead-in is the area that contains the TOC data and precedes each program area. The main channel in the Lead-in area contains audio or data null information. This area is coded as track zero. The Q Sub-channel in this area is coded with the Table of Contents information.

The DVD Lead-in area is the area comprising physical sectors 1.2 mm wide or more adjacent to the inside of the Data area. The area contains the Control data and precedes the Data area.

3.1.79 Lead-out

On CD media the Lead-out is the area that follows each program area. The main channel in the Lead-out area contains audio or data null information. This area is coded as track AAh.

The DVD Lead-out area is the area comprising physical sectors 1.0 mm wide or more adjacent to the outside of the data area in single layered disc for PTP (Parallel Track Path) disc, or the area comprising physical sectors 1.2 mm wide or more adjacent to the inside of the data area in layer 1 of OTP (Opposite Track Path) disc.

3.1.80 L-EC (Layered Error Correction)

L-EC is another name for C3 error correction. See 3.1.14.

3.1.81 Logical Block

The Initiator addressable units of data are named Logical Blocks.

3.1.82 LBA (Logical Block Address)

The LBA is the number that an Initiator uses to reference Logical Blocks on a block storage device.

3.1.83 Logical Track

This is a generic term for a logical subdivision of the address space of optical media. On CD and DDCD media a logical track is a track. On DVD-R/-RW media a logical track is a Rzone. On DVD+R media a logical track is a fragment. For all other media types where logical track is not defined, the entire user space of the media is viewed as a single logical track.

3.1.84 Logical Unit

A Logical Unit is a physical or virtual peripheral device addressable through a target.

3.1.85 Logical Unit Busy

A Logical Unit is Busy if it is executing some process and yet is still able to accept new commands. e.g., when the Logical Unit is currently executing a command that had an immediate bit (IMMED) set to one in its CDB, it may be unavailable to accept and process all commands. See 4.1.6.2.

3.1.86 LUN (Logical Unit Number)

The LUN is the address of a Logical Unit via a target.

3.1.87 Magazine

This is a term for multiple disc unit/container.

3.1.88 MCN (Media Catalog Number)

This 13 BCD number is found in CD sub-channel in at least one out of every one hundred consecutive CD frames. The number is typically registered with a public or private service. See EAN and UPC.

3.1.89 MDT (Main Defect Table)

A MRW disc stores its defect mappings and other format management information in this structure. The MDT is written into the MTA – an area in the disc lead-in.

3.1.90 Medium

Within this publication, medium refers to a single disc: CD or DVD.

3.1.91 Method 1 Addressing

For all CD media, method 1 addressing is a linearization of MSF addresses. If absolute location MSF is in the program area, then $LBA = 4\ 500 * M + 75 * S + F - 150$. Method 1 logical sector numbering is not defined for sectors outside of the program area.

3.1.92 Method 2 Addressing

For CD-R and CD-RW media, method 2 addressing is defined for the logical numbering of sectors on a fixed packet written disk. Link, run-in, and run-out blocks are ignored in the logical sector numbering.

3.1.93 Method 3 Addressing

Method 3 is an extension of method 2. It is the LBA translation method for CD-MRW formatted media. See 4.5.

3.1.94 Middle Area

Area comprising physical sectors 1.0 mm wide or more adjacent to the outside of the Data Area in OTP (Opposite Track Path) disc on both layers of DVD media.

3.1.95 MIP (Main Information Packet)

The Main Information Packet contains information describing the MRW format, status, and defect management system. The MIP is written in the disc lead-in.

3.1.96 MRW (Mount Rainier reWritable)

This general optical media format is defined specifically for rewritable media for the purpose of

providing a defect management scheme without ignoring potential problems with legacy devices. When used on CD-RW media, the format is named CD-MRW. When used on DVD+RW media, the format is named DVD+MRW.

3.1.97 MRW Accessible

At some point during the background formatting process, the Logical Unit provides read/write access for the Initiator. Once the Logical Unit is capable of providing access, the media is MRW Accessible.

3.1.98 MSF address (Minute/Second/Frame)

The physical address expressed as a sector count relative to either the beginning of the medium (absolute) or to the beginning of the current track (relative). As defined by the CD standards, each F field unit is one sector; each S field unit is 75 F field units; each M field unit is 60 S field units. Valid contents of F fields are binary values from 0 through 74. Valid contents of S fields are binary values from 0 through 59. Valid contents of M fields are binary values from 0 through 79. This addressing term has been replaced by the TIME address representation.

3.1.99 MTA (Main Table Area)

The MTA is the MRW disc area in which the MIP and MDT are written.

3.1.100 OPC (Optimum Power Calibration)

OPC is a procedure performed by an optical storage device to calibrate laser power. Values from this calibration are used for subsequent write operation.

3.1.101 Orange Book

The term "Orange Book" refers to a collection of documents from Philips Electronics that describe recordable and rewritable CD systems and media:

- System Description Recordable Compact Disc Systems, part II: CD-R,
- System Description Recordable Compact Disc Systems, part II: CD-R, Volume 2: Multi-Speed,
- System Description Recordable Compact Disc Systems, part III: Compact Disc ReWritable (CD-RW), and
- System Description Recordable Compact Disc Systems, part III Volume 2: CD-RW.

3.1.102 OTP (Opposite Track Path)

An opposite track path DVD is dual layer disc. The Layer 0 groove begins at the inner radius with a Lead in, followed by a user area, and finishes with a Middle area. The Layer 1 groove begins at the outer radius with a Middle area, followed by a user area, and finishes with a lead-out. See 4.4.2.2.

3.1.103 output port

Some MM devices carry a means for connecting to data ports other than the Initiator interface.

3.1.104 PTP (Parallel Track Path)

A parallel track path DVD is a dual layer disc that has a Lead in, user area and Lead-out in each layer respectively. The ID sector number in each layer increases to its respective Lead-out in parallel.

3.1.105 Packet

A packet on CD media is a set of recorded link, run-in, data, and run-out blocks. The UDF (3.1.138) refers to packets as a minimally recordable unit of either 64 KB or 32 KB.

3.1.106 packet size

On CD media the number of Data Blocks in a packet is the packet size.

3.1.107 packet track

A packet track is a CD track written as a concatenation of a pre-gap, written as one or two packets, followed by some non-zero number of user packets.

3.1.108 Physical Sector Number (PSN)

When the total number of possible sectors on a media (even those not typically accessible) is N, physical sector numbering is a one-to-one mapping of the set 0, 1, 2, ...N-1 to the entire set of sectors. No device function (e.g. defect management) may change this mapping.

3.1.109 post-gap

The post-gap is a transition area located at the end of a CD track.

3.1.110 pre-gap

The pre-gap is a transition area located at the beginning of a CD track.

3.1.111 Profile

A profile is a collection of features. The profile is a well-defined way of describing the overall capabilities of a specific Logical Unit. More complex Logical Units may exhibit more than one profile.

3.1.112 Program Area

The program area is the logical address space in CD session.

3.1.113 PMA (Program Memory Area)

The PMA contains information about the recordings on a CD-R/RW disc.

3.1.114 Red Book

The term "Red Book" refers to the Philips Electronics document: System Description Compact Disc Digital Audio. The standard IEC 908:1987, Compact Disc Digital Audio System is the preferred reference.

3.1.115 Regional Code

The regional code is used to identify one or more regions of the world. Currently there are six regions defined.

3.1.116 Region Playback Control (RPC)

RPC limits the playback of DVD-ROM content to specific regions of the world.

3.1.117 relative MSF field

See MSF address definition.

3.1.118 RMA

Recording Management Area

3.1.119 RMD

Recording Management Data

3.1.120 Rzone

Rzone refers to a logical track on DVD-R and DVD-RW media. See Logical Track.

3.1.121 SA (Spare Area)

The MRW format provides for some non-zero number of primary data areas (DA) and for some non-zero number of spare areas (SA).

3.1.122 SDT (Secondary Defect Table)

The MRW format requires a back-up copy of the MDT in the program area of the disc. This back-up copy is the SDT.

3.1.123 Sector

In case of CD media, "Sector" refers to the data contained in one CD frame. In the CD-ROM standard (ISO/IEC 10149) the term block is used for this unit.

In the case of DVD media, Sector is the smallest user addressable part of the media. The user data contained within a sector is 2 048 bytes.

3.1.124 Session

A session is a contiguous area of a CD or DVD Disc that contains a Lead-in, Program Area, and Lead-out.

3.1.125 Single Sided

A single sided DVD disc has exactly one recorded or recordable side.

3.1.126 Small Frame

A small frame is 1/98 of a CD frame.

3.1.127 SIP (Secondary Information Packet)

The Secondary Information Packet contains information describing the MRW defect management system. This is a back-up copy of the MIP.

3.1.128 SK (Sense Key)

Specifically, this refers to the value stored in the low order 4 bits of byte 2 of the sense information as defined in SPC-3.

3.1.129 STA (Secondary Table Area)

This is the MRW disc area in which the SIP and SDT are written.

3.1.130 Sub-channel

CD media have a main channel and a Sub-channel. The Sub-channel area has eight parts called P, Q, R, S, T, U, V, and W. The Q Sub-channel contains information useful to the controller and Logical Unit, such as the control field and MSF address. The data rate of each Sub-channel (P, Q, etc.) is 1/192nd of that of the main channel.

3.1.131 TIME addressing

MSF (Minute, Second, Frame) addressing is used for physical sector addressing on CD media. HMSF (Hour, Minute, Second, Frame) addressing is used for physical sector addressing on DDCD media. The general term for physical addressing on either media is TIME addressing.

3.1.132 Title Key

The Title Key is a value used during the scrambling process of movie data on DVD media.

3.1.133 Table of Contents (TOC)

On CD media, the TOC has information on the type of session and the starting address of the tracks. This information is encoded in the Q Sub-channel in each Lead-in area.

3.1.134 Track Descriptor Block (TDB)

On CD-R/RW media, the TDB contains information on the attributes of the current track.

3.1.135 Track

Track refers to a logical track on CD or DDCD media. Track is a historical term that is often used interchangeably with Logical Track. See Logical Track.

3.1.136 Track at Once

On CD-R/RW media when a track, including its pre-gap, is written as a single packet, the track is said to be recorded track at once (TAO).

3.1.137 Transition area

For CD a transition area is a sequence of sectors at the beginning or end of tracks e.g. Pause Area, Pre-Gap, Lead-out, Post-Gap.

3.1.138 UDF (Universal Disk Format)

The description of a file system designed for MM recordables and based upon the ECMA 167.

3.1.139 UPC (Uniform Product Code)

Controlled by the UC Council, Inc., located at 1009 Lenox Drive, Suite 202 Lawrenceville, NJ 08648. See MCN.

3.1.140 Uninterrupted Recording

Also known as Disc-At-Once (DAO) recording, uninterrupted recording on CD-R/RW is performed without any linkage sequence. This is only possible when an entire disc is recorded in a single write stream.

3.1.141 Yellow book

The term "Yellow Book" refers to the Philips Electronics document: Compact Disc Read Only Memory. The preferred reference is ISO/IEC 10149, Information Technology-Data Interchange on Read-only 120 mm Optical Data Discs (CD-ROM).

3.2 List of Abbreviations and Acronyms

ADIP	Address In Pre-groove	DZ	Data Zone (on DVD media)
AGID	Authentication Grant ID	EAN	European Article Number
ASC	Additional Sense Code	ECC	Error Correction Code
ASCQ	Additional Sense Code Qualifier	EDC	Error Detection Code
ATA	AT Attachment	EFM	Eight-to-Fourteen Modulation code
ATAPI	AT Attachment Packet Interface	GAA	General Application Area
ATIP	Absolute Time In Pre-groove	HMSF	Hour/Minute/Second/Frame
BCA	Burst Cutting Area	ID	Identification Data
BCD	Binary Coded Decimal	IED	ID Error Detection
BG	Background	L-EC	Layered Error Correction
CDB	Command Descriptor Block	LBA	Logical Block Address
CD	Compact Disc	LSB	Least Significant Bit
CDZ	Control Data Zone (on DVD media)	LUN	Logical Unit Number
CD-DA	CD – Digital Audio	MCN	Media Catalog Number
CD-R	CD – Recordable	MDT	Main Defect Table
CD-ROM	CD – Read Only Memory	MIP	Main Information Packet
CD R/RW	a CD-R, a CD-RW, or both	MM	Multi-Media
CD-RW	CD ReWritable	MRW	Mount Rainier reWritable
CPPM	Content Protection for Prerecorded Media	MSB	Most Significant Bit
CPRM	Content Protection for Recordable Media	MSF	Minute/Second/Frame
CIRC	Cross Interleaved Reed-Solomon Code	MTA	Main Table Area
DA	Data Area	OPC	Optimum Power Calibration
DBI	Defective Block Information	OTP	Opposite Track Path
DDCD	Double Density Compact Disc	PTP	Parallel Track Path
DDCD-R	DDCD Recordable	PMA	Program Memory Area
DDCD-ROM	DDCD – Read Only Memory	PSN	Physical Number
DDCD-R/RW	DDCD-R, DDCD-RW, or both	RPC	Region Playback Control
DDCD-RW	DDCD ReWritable	SA	Spare Area
DVD	Digital Versatile Disc	SDT	Secondary Defect Table
DVD-R	DVD Recordable	SIP	Secondary Information Packet
DVD-RW	DVD Re-recordable	SK	Sense Key
DVD-R/-RW	DVD-R, DVD-RW or both	STA	Secondary Table Area
DVD-RAM	DVD-Random Access Memory	TOC	Table of Contents
DVD-ROM	DVD-Read Only Memory	TDB	Track Descriptor Block
DVD+R	DVD Recordable	TAO	Track at Once
DVD+RW	DVD ReWritable	UDF	Universal Disk Format
DVD+R/+RW	DVD+R, DVD+RW or both	UPC	Uniform Product Code

3.3 Keywords

3.3.1 expected

A keyword used to describe the behavior of the hardware or software in the design models assumed by this standard. Other hardware and software design models may also be implemented.

3.3.2 legacy

Bits, bytes, fields, and code values that have been defined in previous standards but have been replaced by preferred methods in this standard may be considered obsolete. If the method has long-standing history of use, then obsoleting the method may be detrimental to many users and should then be defined as legacy rather than obsolete.

Initiators should not use legacy commands or mode pages.

Devices conforming to this standard should not support commands or mode pages defined as legacy in previous standards.

Legacy methods do not appear in the main body of this or subsequent standards.

Legacy methods that are considered important are documented in an informative annex of this and subsequent standards until deemed obsolete. Devices implementing legacy commands or mode pages shall implement them according to the most recent and appropriate standard that carries a definition.

3.3.3 may

A keyword that indicates flexibility of choice with no implied preference (equivalent to “may or may not”).

3.3.4 may not

A keyword that indicates flexibility of choice with no implied preference (equivalent to “may or may not”).

3.3.5 shall

A keyword indicating a mandatory requirement. Designers are required to implement all such mandatory requirements to ensure interoperability with other standard conforming products.

3.3.6 should

A keyword indicating flexibility of choice with a strongly preferred alternative. Equivalent to the phrase “it is recommended.”

3.3.7 obsolete

A keyword used to describe bits, bytes, fields, and code values that may have been defined in previous standards are not defined in this standard and shall not be reclaimed for other uses in future standards.

However, some degree of functionality may be required for items designated as “obsolete” to provide for backward compatibility. The Initiator should not use obsolete commands or mode pages.

Devices conforming to this standard should not support commands or mode pages defined as obsolete in previous standards. Devices implementing obsolete commands or mode pages shall implement them according to the most recent and appropriate standard that carries a definition.

If obsolete bits, bytes, fields, or code values are not implemented, their value shall be reserved.

3.3.8 mandatory

A keyword indicating items required to be implemented as defined by this standard.

3.3.9 optional

A keyword that describes Features that are not required for compliance to this standard. However, if any optional Feature defined is implemented, it shall be implemented as defined by this standard.

3.3.10 reserved

A keyword referring to bits, bytes, words, fields and code values that are set aside for future standardization. A reserved bit, byte, word or field shall be set to zero, or in accordance with a future extension to this standard. Recipients are not required to check reserved bits, bytes, words or fields for zero values. Receipt of reserved code values in defined fields shall be reported as error.

3.4 Conventions

Various conventions are used through out this standard and are identified in this sub-clause.

Certain words and terms used in this standard have a specific meaning beyond the normal English meaning. These words and terms are defined either in 3.1 or in the text where they first appear.

Names of commands, statuses, sense keys, and additional sense codes are in all uppercase (e.g., REQUEST SENSE). Lowercase is used for words having the normal English meaning.

If there is more than one CDB length for a particular command (e.g., MODE SENSE(6) and MODE SENSE(10)) and the name of the command is used in a sentence without any CDB length descriptor (e.g., MODE SENSE), then the condition specified in the sentence applies to all CDB lengths for that command.

The names of fields are in uppercase (e.g., ALLOCATION LENGTH). Normal case is used when the contents of a field are being discussed. Fields containing only one bit are usually referred to as the name bit instead of the name field.

The decimal sign is a comma (,) on the line between the whole and fractional numbers. Spaces are used to separate groups of three digits on either side of the decimal sign. A value less than 1 is written with a zero preceding the decimal sign. Numbers that are not immediately followed by lowercase "b," "h," or "bcd" are decimal values.

Numbers immediately followed by lowercase "b" (xxb) are binary values.

Numbers immediately followed by lowercase "h" (xxh) are hexadecimal values.

Numbers immediately followed by lowercase "bcd" (xxbcd) are binary coded decimal values.

Values indicated by a lower case "k" have a base value of 1 000 units.

Values indicated by an uppercase "K" have a base value of 1 024 units.

Values indicated by a lower case "m" have a base value of 1 000 000 units.

Values indicated by an uppercase "M" have a base value of 1 048 576 units.

Values indicated by a lower case "g" have a base value of 1 000 000 000 units.

Values indicated by an uppercase "G" have a base value of 1 073 741 824 units.

When the value of the bit or field is not relevant, x or xx appears in place of a specific value.

Lists sequenced by letters (e.g., a-red, b-blue, c-green) show no priority relationship between the listed items.

Numbered lists (e.g., 1-red, 2-blue, 3-green) show a priority ordering between the listed items. If a conflict arises between text, tables, or figures, the order of precedence to resolve the conflicts is text; then tables; and finally figures. Not all tables or figures are fully described in the text. Tables show data format and values.

Notes do not constitute any requirements for implementors.

Recommended error code tables defined within each command sub-clause uses the following:

Errors shown in mixed case indicate all errors, in that class, are valid.

Errors shown in uppercase refer to the identified specific error condition.

The string SK/ASC/ASCQ refers to the low order 4 bits of byte 2 and bytes 12, and 13 in the referenced Logical Unit's sense data. SK/ASC/ASCQ is used interchangeably with the names associated with the coded values in those sense bytes. In this standard, the numeric SK value may be replaced by its equivalent text. The numeric values of ASC and ASCQ are typically replaced by a single text phrase. e.g., when the numeric values for SK/ASC/ASCQ are 03h/11h/05h, the text replacements are MEDIUM ERROR/L-EC UNCORRECTABLE ERROR.

If a reference is made to a document or standard, the document or standard name appears in italics.

Formulae appear in italics.

3.5 Bit and byte ordering

This subclause describes the representation of fields in a table that defines the format of a SCSI structure (e.g., the format of a CDB).

If a field consists of more than one bit and contains a single value (e.g., a number), the least significant bit (LSB) is shown on the right and the most significant bit (MSB) is shown on the left (e.g., in a byte, bit 7 is the MSB and is shown on the left; and bit 0 is the LSB and is shown on the right). The MSB and LSB are not labeled if the field consists of 8 or fewer bits.

If a field consists of more than one byte and contains a single value, the byte containing the MSB is stored at the lowest address and the byte containing the LSB is stored at the highest address (i.e., big-endian byte ordering). The MSB and LSB are labeled.

If a field consists of more than one byte and contains multiple fields each with their own values (e.g., a descriptor), there is no MSB and LSB of the field itself and thus there are no MSB and LSB labels. Each individual field has an MSB and LSB that are labeled as appropriate in the table (if any) that describes the format of the sub-structure having multiple fields.

If a field contains a text string (e.g., ASCII), the MSB label is the MSB of the first character and the LSB label is the LSB of the last character.

When required for clarity, multiple byte fields may be represented with only two rows in a table. This condition is represented by values in the byte number column not increasing by one in each subsequent table row, thus indicating the presence of additional bytes.

**This page is intentionally
blank.**

4 Multi-Media Device Models

4.1 General

4.1.1 Media Organization

A multi-media (MM) device is defined primarily by the media it supports: CD, DDCD, DVD and each sub-case: read-only, recordable, rewritable. Additionally, the devices are defined by specific capabilities associated with each media type. MM devices may also carry additional capabilities such as integrated media changers.

With each capability, there is modeling that describes it. This clause describes each multi-media device model.

MM devices operate with media that has 3 distinct areas: Lead-in, User Data Area, and Lead-out (Figure 1).

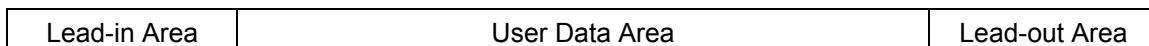

Figure 1 – General Media Structure

Each area is a succession of physical sectors (blocks) where each block has a unique physical address.

The lead-in is a zone of protection that separates the beginning of the recorded/recordable area from the physical start of the User Data Area. The lead-in zone may contain information that relates to organization of the recorded space.

The lead-out is a zone of protection that separates the physical end of the User Data Area from the end of the recorded/recordable area. The lead-out zone may contain information that relates to organization of the recorded space.

4.1.2 Logical Blocks

Multi-media devices store blocks of data for later retrieval. Each block of data is stored at a unique logical block address. When the media is writable, an Initiator issues WRITE commands to store the blocks of data (write operations) and READ commands to retrieve the blocks of data (read operations). Other commands issued by the Initiator may also cause write and read operations to occur. A write operation causes one or more blocks of data to be written on the medium. A read operation causes one or more blocks of data to be read from the medium. A verify operation confirms that one or more blocks of data were correctly written and may be read without error from the medium.

Blocks of data are stored on the medium along with additional information that the Logical Unit uses to manage storage and retrieval. The format of the additional information is unique and is hidden from the Initiator during normal reading or writing. This additional information is often used to identify the physical location of a block of data, the logical address of the logical block(s), and to provide protection against the loss of the user data.

Each logical block has a unique logical block address (LBA). The LBA of the first logical block is zero. The LBA of the last logical block is $N - 1$, where N is the number of logical blocks available on the medium. Each integer between zero and $N - 1$ is an LBA and is associated with a unique block. A READ CAPACITY command may be issued to determine the value of $N - 1$. If a command is issued that requests access to a logical block address not within the capacity of the medium, the command shall be terminated with CHECK CONDITION status and the SK/ASC/ASCQ values shall be set to ILLEGAL REQUEST/LOGICAL BLOCK ADDRESS OUT OF RANGE.

The number of bytes of data contained in a logical block is known as the block length. Each logical block has a block length associated with it. Block storage Logical Units (as defined in the SBC) use the Block Descriptor structure in mode data for the definition of block size. Multi-media Logical Units do not support Block Descriptors. The Block Descriptor Length field in the Mode Data Header shall be set to zero. Non-zero values for the Block Descriptor Length field of the Mode Data Header have

been made obsolete in this standard for all Logical Units. When accessing the media with READ (10), READ (12), VERIFY (10), or VERIFY (12), the block length shall be 2 048 bytes. Block size is self defined by READ CD and READ CD MSF commands. When the media is CD-R/-RW and the media is accessed with WRITE (10) or WRITE (12), block length is determined by the Write Parameters mode page.

In a typical Logical Unit the logical blocks are located in an ascending order. However, the location of a logical block on the medium is not required to have a specific relationship to the location of any other logical block. The time to access the logical block at address X and then the logical block at address X+1 may not be less than time to access X and then any other block on the medium.

4.1.3 Logical Sub-Divisions of Media

4.1.3.1 General

Some MM media types support a logical subdivision of the address space. These sub-divisions typically require some LBA space for overhead. These overhead areas are not available for user data and reading may not be possible.

4.1.3.2 Logical Tracks

The LBA space of CD media may be divided into contiguous areas called tracks. The LBA space of DVD-R and DVD-RW media may be divided into contiguous areas called rzones. The LBA space of DVD+R media may be divided into contiguous areas called fragments. In each case, the start address of the area may be discovered independently to facilitate faster access. Because each of these sub-divisions has similar characteristics to the others, this standard refers to the generic variant of this logical sub-division as a Logical Track.

A logical track typically loses a non-zero, format dependent number of LBAs at its beginning and at its end. The Initiator may discover information about logical tracks by using the READ TOC/PMA/ATIP and READ TRACK INFORMATION commands.

Each MM media type that supports multiple logical tracks (CD, DVD-R, DVD-RW, and DVD+R) may be structured to have exactly one logical track. Each of the other MM media types that do not support multiple logical tracks are always viewed to have exactly one logical track consisting of the LBA space of the disc.

The minimum number of logical tracks on any MM media type is one. The maximum number of logical tracks is media type dependent. Logical tracks are integrally numbered beginning with an integer no smaller than 1.

4.1.3.3 Sessions

A contiguous set of recorded blocks consisting of a lead-in area, user data area, and a lead-out area is known as a session. The user area of a session shall contain at least one logical track. A fully recorded MM disc shall contain at least one session.

The minimum number of session on any recorded MM media type is one. The maximum number of sessions is media type dependent. Sessions are numbered integrally beginning with 1.

The lead-in area for the first session is the lead-in of the disc. The lead-out area for the last session is the lead-out area for the disc. The user data area for any session may be sub-divided into logical tracks.

Information about disc structure is given by the READ DISC INFORMATION command. Information about session structure is discovered in data returned by the READ TRACK INFORMATION command.

The general view of disc, session and logical track decomposition is shown in Figure 2.

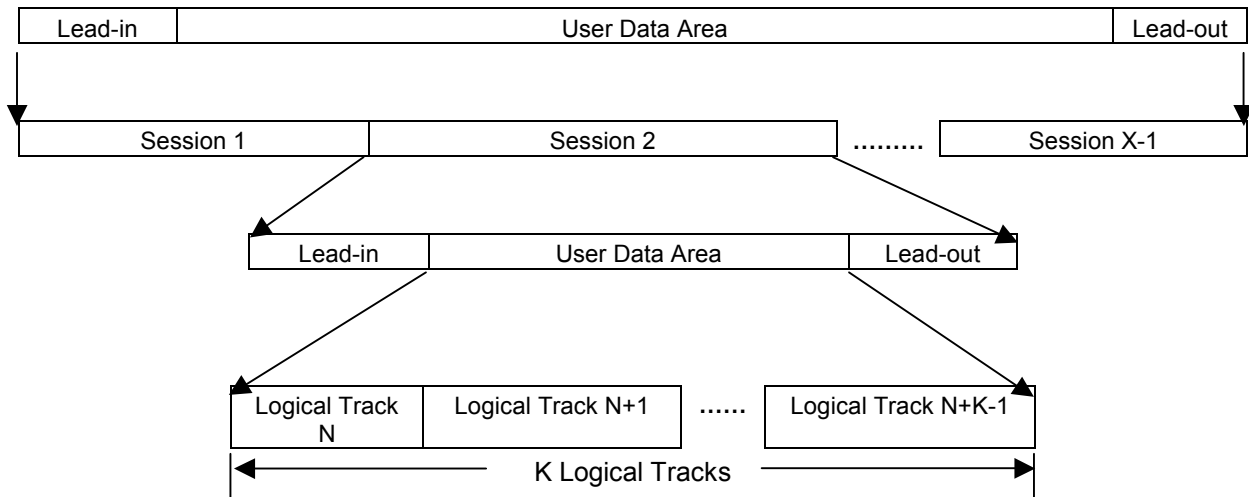

Figure 2 – Disc, Session and Logical Track Decomposition

4.1.4 Data cache

Many Logical Units implement cache memory. A cache memory is usually an area of temporary storage in the Logical Unit that has fast access time and is used to enhance performance. It exists separately from the blocks of data stored and is normally not directly addressable by the Initiator. Use of cache memory for write or read operations typically reduces the access time to a logical block and may increase the overall data throughput.

During read operations, the Logical Unit uses the cache memory to store blocks of data that the Initiator may request at some future time. The algorithm used to manage the cache memory is not part of this specification. However, parameters are provided to advise the Logical Unit about future requests, or to restrict the use of cache memory for a particular request.

Sometimes the Initiator may request that the blocks of data read from the medium instead of from the cache memory. The force unit access (FUA) bit in the CDBs of some commands is used to indicate that the Logical Unit shall access the physical medium. For a write operation, setting FUA to one causes the Logical Unit to complete the data write to the physical medium before completing the command. For a read operation, setting FUA to one causes the logical blocks to be retrieved from the physical medium.

The Logical Unit may implement commands that allow the Initiator to control other behavior of the cache memory:

- The MODE SENSE (10) Command defines a page for the control of cache behavior and handles certain basic elements of cache replacement algorithms.
- The SYNCHRONIZE CACHE Command is used by the Initiator to guarantee that data in the cache has been moved to the media.

4.1.5 Resets

4.1.5.1 Reset Types

Within this standard there are three resets identified. These resets are named:

- a) Power-On Reset
- b) Hard Reset
- c) Device Reset

These resets are used differently in each physical interface referenced. For more information on the use in specific physical interfaces, see the appropriate Annex on implementation notes.

4.1.5.2 Power-On Reset

When power is applied, the Logical Unit processes a series of electrical circuitry diagnostics, resets

Logical Unit specific parameters (mode pages) to default values, and if media is present, may spin up and make the Logical Unit ready for use. In addition, power management and key management are reset to their default states.

4.1.5.3 Hard Reset

For each physical interface the detection of Hard Reset is different. The Logical Unit processes a series of electrical circuitry diagnostics, resets Logical Unit specific parameters (mode pages) to default values, and if media is present, may spin up and make the Logical Unit ready for use. In addition power management and key management are reset to their default states. The behavior of the Logical Unit when Hard Reset is received is the same as for Power On Reset.

Hard Reset is used to reset Logical Units or even a whole interface bus, not individual Logical Units.

4.1.5.4 Device Reset

For each physical interface the detection of Device Reset is different. The Device Reset is used to bring a non-responding Logical Unit into an operable state. Device Reset is different from Power On or Hard Reset. With the Device Reset the parameters being used by the Logical Unit are not set to the defaults. In some cases this may not be possible and the Logical Unit may need to reset to the default conditions. If a reset to default conditions occurs as a result of a Device Reset, a Unit attention condition and Power Management Event Notification shall be generated. Logical Unit should:

- 1) Reset Initiator interface circuitry.
- 2) Perform hardware initialization and device-internal diagnostics only if necessary.
- 3) Do not revert to the default conditions, Logical Unit Number or TOC information.
- 4) Stay in the current Power State.
- 5) Not change Persistent Prevent state.
- 6) Reset Key management to the default state.

4.1.6 Error reporting

4.1.6.1 Unit Attention Conditions

If an Initiator issues a command other than GET CONFIGURATION, GET EVENT STATUS NOTIFICATION, INQUIRY or REQUEST SENSE while a unit attention condition exists for that Initiator, the logical unit shall not perform the command and shall report CHECK CONDITION status unless a higher priority status as defined by the logical unit is also pending.

4.1.6.2 Logical Unit Busy Conditions

A Logical Unit may become Busy, thereby limiting the number of commands that may be processed to completion.

While a Logical Unit is Busy, it shall accept and process REQUEST SENSE, INQUIRY, GET CONFIGURATION, GET EVENT STATUS NOTIFICATION, and TEST UNIT READY. However, the Logical Unit may not be able to process some commands and shall respond with CHECK CONDITION status with sense key set to NOT READY, ASC set to LOGICAL UNIT NOT READY, and ASCQ set to OPERATION IN PROGRESS, LONG WRITE IN PROGRESS, or FORMAT IN PROGRESS.

Commands that have an immediate bit set to one in their CDBs may cause a Logical Unit Busy condition.

A Logical Unit may become Busy under the conditions described above, however, the Logical Unit is not required to become Busy. e.g., if the Initiator sends a CLOSE TRACK SESSION command with immediate bit set to one to close a track and the track is already closed, the Logical Unit may terminate the command with GOOD status and never enter the Logical Unit Busy condition.

During cached recording when the write buffer has become full, a Logical Unit may respond to a WRITE command with CHECK CONDITION status and sense bytes SK/ASC/ASCQ set to NOT READY/LOGICAL UNIT NOT READY/LONG WRITE IN PROGRESS. This particular case is not a Logical Unit Busy condition.

When a Logical Unit that was not busy, becomes busy, a Device Busy Event shall be generated indicating that the Busy State has changed and the Busy State is Busy.

When a Logical Unit that was busy, becomes not busy, a Device Busy Event shall be generated indicating that the Busy State has changed and the Busy State is Not Busy.

Device Busy Event reporting is described in 6.7.2.7.

Table 1 shows examples of error reporting during a Logical Unit Busy condition.

Table 1 – Busy Condition Examples

Situation	SK Value	ASC Value	ASCQ Value
BLANK command with CDB Immediate bit set to one is in progress	NOT READY	LOGICAL UNIT NOT READY	OPERATION IN PROGRESS or LONG WRITE IN PROGRESS
CLOSE TRACK SESSION command with CDB Immediate bit set to one is in progress	NOT READY	LOGICAL UNIT NOT READY	OPERATION IN PROGRESS or LONG WRITE IN PROGRESS
FORMAT UNIT command with parameter list Immediate bit set to one is in progress	NOT READY	LOGICAL UNIT NOT READY	FORMAT IN PROGRESS
Last WRITE command in a DAO recording. This is equivalent to sending a SYNCHRONIZE CACHE command with the immediate bit set to one.	NOT READY	LOGICAL UNIT NOT READY	LONG WRITE IN PROGRESS

4.1.6.3 Unable to Write Errors

Logical Units that possess no feature indicating write capability shall respond to any command that requires writing with CHECK CONDITION status and set sense bytes SK/ASC/ASCQ to ILLEGAL REQUEST/INVALID COMMAND OPERATION CODE.

Logical Units that possess one or more write features may be unable to write. If the Initiator sends a command that requires writing to the currently mounted medium, but some condition exists such that the Logical Unit is not capable of writing to the media, the command shall be terminated with CHECK CONDITION status and sense bytes SK/ASC/ASCQ shall be set according to Table 2.

Table 2 – SK/ASC/ASCQ Specification for Unable to Write Situations

Error Situation	SK/ASC/ASCQ
Medium is read-only.	ILLEGAL REQUEST/CANNOT WRITE MEDIUM – INCOMPATIBLE FORMAT
Medium is write-once. Initiator is attempting overwrite.	ILLEGAL REQUEST/INVALID FIELD IN CDB, or ILLEGAL REQUEST/INVALID ADDRESS FOR WRITE, or Sense key is set to BLANK CHECK and ASC /ASCQ is not specified in this standard.
Medium is write protected.	DATA PROTECT/WRITE PROTECTED – The ASCQ shall be set as described in Table 66.
Logical Unit is not capable of writing to the specific physical media/media format. e.g., writable DVD medium in a CD recorder with no DVD capability.	NOT READY/MEDIUM NOT PRESENT (device is unable to detect the presence of media), or NOT READY/CANNOT WRITE MEDIUM – INCOMPATIBLE MEDIUM (device detects media presence, but is unable to identify media), or ILLEGAL REQUEST/CANNOT WRITE MEDIUM – INCOMPATIBLE MEDIUM (device only has read capability)
The Logical Unit is able to write some versions of the currently mounted media type, but not the version of currently mounted media.	ILLEGAL REQUEST/CANNOT WRITE MEDIUM – INCOMPATIBLE FORMAT, or ILLEGAL REQUEST/CANNOT WRITE MEDIUM – UNSUPPORTED MEDIUM VERSION

4.1.6.4 Deferred Errors

Some MM Logical Units may support commands that return GOOD status prior to actual command execution. These commands are associated with the use of the immediate bit or some forms of write caching. Multi-media Logical Units that implement these features shall implement deferred error reporting. See SPC-3 for definition and handling.

4.1.7 Removable medium

A disc has an attribute of either being mounted or unmounted on a suitable transport mechanism. A disc is mounted when the Logical Unit is capable of performing read operations to the medium. A mounted disc may not be accessible by an Initiator, if another Initiator has reserved it. A disc is unmounted at any other time (e.g. during loading, unloading, or storage). An Initiator may check the mounted status by issuing a TEST UNIT READY command.

The REMOVABLE MEDIUM Feature provides the Initiator with commands to load or eject media and to prevent the removal of any media.

The PREVENT ALLOW MEDIUM REMOVAL command allows an Initiator to restrict the de-mounting of the disc. This is useful in maintaining system integrity. If the Logical Unit implements cache memory, it shall ensure that all logical blocks of the medium contain the most recent data prior to permitting de-mounting of the disc. If the Initiator issues a START STOP UNIT command to eject the disc, and is prevented from de-mounting by the PREVENT ALLOW MEDIUM REMOVAL command, the START/STOP UNIT command is rejected by the Logical Unit.

When the Persistent Prevent state is entered, the media shall remain locked in the Logical Unit, until the Initiator issues an eject request, or a power on or hard reset condition occurs. The Persistent Prevent state shall be maintained after the eject request. New media that is inserted into the Logical

Unit shall be locked in the Logical Unit after the Logical Unit reports the NEW MEDIA event. Prior to reporting the NEW MEDIA event, the Logical Unit may eject media without an explicit eject command from the Initiator. This allows the user to remove incorrectly inserted media without having to wait for Initiator intervention.

While in the Persistent prevent state, the Logical Unit shall generate Events upon receipt of a User Eject request. The Logical Unit shall not eject the media on receipt of these requests if the Logical Unit has already reported a NEW MEDIA event for this media. If a Logical Unit allows an eject between generating and reporting the NEW MEDIA event, the Logical Unit shall remove the NEW MEDIA event(s) from the Event queue. When the Initiator receives the Eject Request and determines that it is safe to eject the medium, an eject command (START STOP UNIT command with LoEj bit set to one) should be issued. At that time the Logical Unit shall eject the medium. The Persistent Prevent State shall be retained.

The Logical Unit shall only generate GET EVENT STATUS NOTIFICATION (EJECT REQUEST) events after reporting a GET EVENT STATUS NOTIFICATION (NEW MEDIA) event, and prior to reporting a GET EVENT STATUS NOTIFICATION (MEDIA REMOVAL) event for the given media.

To maintain compatibility with existing BIOS implementations and operating systems, the Logical Unit shall default to Persistent Prevent disabled. When the Initiator enables the support using the PREVENT ALLOW MEDIUM REMOVAL command, the Logical Unit shall respond as described in this specification. When the Initiator disables this Feature, the Logical Unit shall default to normal operating modes. A power on or hard reset shall cause the Logical Unit to return to the default Persistent Prevent state.

If the Logical Unit is unable to maintain media status information across a reset or power cycle, the Logical Unit shall generate a NEW MEDIA event.

Commands shall be processed exactly the same as if Persistent Prevent was not enabled. For compatibility reasons, a unit attention condition shall be generated. Execution of the GET EVENT STATUS NOTIFICATION command does not include terminating with CHECK CONDITION status when a unit attention condition is pending. e.g., if the user inserts a new medium and the Logical Unit is accessed with a command, a unit attention condition shall be generated, but the Logical Unit shall also report the NEW MEDIA Event with the next available GET EVENT STATUS NOTIFICATION (Media Status) command.

4.1.8 Timeouts

4.1.8.1 General

Many Initiator implementations associate a time limit for execution of each command. If a command has not reported status, but the Initiator's time limit has expired, the Initiator has few options in forcing termination of the command. Typically, the Initiator chooses to reset the Logical Unit. Since the Logical Unit may not be able to prepare for such an abrupt termination, the action may have detrimental effects.

Commands are separated into two groups: Group 1 and Group 2. If a Group 1 command that times out, the Initiator should retry the command. Group 2 commands should not be retried.

Group 3 timeout is a modified version of Group 1 timeout for streaming applications. Consequently, READ (12), VERIFY (10), and WRITE (12) may operate differently.

4.1.8.2 Group 1 Timeouts

Commands in Group 1 should always be retried when the Logical Unit is ready. Commands with the Group 1 timeout are shown in Table 3.

Table 3 –Commands with Group 1 Timeout

Command	Operation Code	Command	Operation Code
GET PERFORMANCE	ACh	READ TRACK INFORMATION	52h
MECHANISM STATUS	BDh	REPAIR TRACK	58h
MODE SELECT	55h, 15h	REPORT KEY	A4h
MODE SENSE	5Ah, 1Ah	REPORT LUNS	A0h
PAUSE/RESUME	4Bh	REZERO UNIT	01h
PLAY AUDIO	45h, A5h	SCAN	BAh
PLAY AUDIO MSF	47h	SEEK	2Bh
PLAY CD	BCh	SEND CUE SHEET	5Dh
PREFETCH	34h	SEND DVD STRUCTURE	BFh
PREVENT ALLOW MEDIUM REMOVAL	1Eh	SEND EVENT	A2h
READ (see note 2)	28h, A8h	SEND KEY	A3h
READ BUFFER	3Ch	SEND OPC INFORMATION	54h
READ BUFFER CAPACITY	5Ch	SET CD SPEED	BBh
READ CAPACITY	25h	SET READ AHEAD	A7h
READ CD	BEh	SET STREAMING	B6h
READ CD MSF	B9h	START STOP UNIT	1Bh
READ DISC INFORMATION	51h	STOP PLAY/SCAN	4Eh
READ DVD STRUCTURE	ADh	TEST UNIT READY	00h
READ FORMAT CAPACITIES	23h	WRITE (see note 2)	2Ah, AAh
READ SUB-CHANNEL	42h	WRITE BUFFER	3Bh
READ TOC/PMA/ATIP	43h	WRITE AND VERIFY	2Eh

NOTE 2: If the logical unit supports Group3 time-out and the G3Enable bit in Time-out & Protect Mode Page (1Dh) is set to 1, READ (12) with Streaming = 1 and WRITE (12) with Streaming = 1 are categorized as Group 3 time-out. Otherwise, the commands are Group 1.

The Group 1 time limit in the Timeout and Protect Page specifies sets a time limit for Group 1 commands. If command execution requires more than the allowed time, the command shall be terminated with CHECK CONDITION status and sense key shall be set to either NOT READY or UNIT ATTENTION and ASC shall be set to INSUFFICIENT TIME FOR OPERATION. Additionally, the Logical Unit shall set the Command Specific Information sense bytes to the minimum timeout value in seconds that should be used when retrying the command. The Initiator's response should be to retry the command with the requested timeout.

The Logical Unit is permitted to terminate the command prior to the timeout if it has determined that the command may not be completed within the allowed time.

4.1.8.3 Group 2 Timeouts

Group 2 contains commands that may be unable to complete successfully if retried. It is important that the Initiator specify a Group 2 timeout that is large enough to allow the command to complete under worst-case scenarios. Commands with the Group 2 timeout are shown in Table 4.

Table 4 – Group 2 Timeout Commands

Command	Operation Code	Command	Operation Code
BLANK	A1h	RESERVE TRACK	53h
CLOSE TRACK/SESSION	5Bh	SYNCHRONIZE CACHE	35h
FORMAT UNIT	04h	VERIFY (10)	2Fh
LOAD/UNLOAD MEDIUM	A6h	VERIFY (12)	Afh

NOTE 3: If the logical unit supports Group3 time-out and the G3Enable bit in Time-out & Protect Mode Page (1Dh) is set to 1, VERIFY (10) and VERIFY (12) are categorized as Group 3 time-out. Otherwise, the commands are Group 2.

If a Group 2 command has an immediate bit in its CDB and IMMED = 1, Timeout is not allowed for any Group 2 command. Command status shall be returned within the Group 1 time.

4.1.8.4 No Timeout Commands

Some commands should be able to be processed with no dependence on the readiness of the mounted medium. These commands shall not timeout. These are listed in Table 5.

Table 5 – No Timeout Commands

Command	Operation Code	Command	Operation Code
GET CONFIGURATION	46h	RELEASE	17h, 57h
GET EVENT/STATUS NOTIFICATION	4Ah	REQUEST SENSE	03h
INQUIRY	12h	RESERVE	16h, 56h
RECEIVE DIAGNOSTIC RESULTS	1Ch	SEND DIAGNOSTICS	1Dh

4.1.8.5 Group 3 timeout for Real Time Stream recording/playback

4.1.8.5.1 General

Some Group 1 and Group 2 timeout commands become Group 3 timeout commands when G3tout in the READ/WRITE ERROR RECOVERY MODE PAGE is set to one. See Table 6.

Table 6 – Group 3 Timeout Commands

Command	Operation Code	Command	Operation Code
READ (12) when Streaming = 1	A8h	VERIFY (12)	Afh
VERIFY (10)	2Fh	WRITE (12) when Streaming = 1	AAh

To adjust application setting of real-time stream recording/playback to recover from fatal error, observation of expected time length for the command is necessary. Group 3 timeout is assigned for this purposes. A logical unit shall terminate READ (12)/WRITE (12) command with Streaming = 1 and VERIFY (10) command with G3tout bit=1, within expected time length defined as follows.

Expected time = Group3 time unit * Ceil(Transfer length / Unit length) + trace time for requested blocks. Ceil(x) returns the least integer value greater than or equal to x.

Group 3 time unit: a unit for Group 3 Timeout that correspond to read/write one sector

Unit length: a unit of block length correspond to increase a unit of Group 3 time unit

trace time: time to read/write blocks excluding access time and read/write time of the first sector.

Group 3 time unit value shows the maximum time of operation when the transfer length field is set to 1 and when Power state of Logical Unit is Active state. In case of DVD-RAM, Group 3 time unit value should include 1 zone transition time.

The recommended value for Group 3 time unit is 1 to 5 seconds. The recommended value for Unit length is 256 sectors.

It is recommended that transfer length and verification length are set to smaller than Unit length value. If Initiator uses transfer length less than Unit length, the Expected time is similar with Group 3 time unit as follows: (in the case of DVD, 256 sectors is only 0.38 sec. At 1X speed.)

Expected time = Group3 time unit + trace time for requested blocks

Group3 time unit shall not be changed by a medium change. A logical unit may accept the value change by the Initiator. The Initiator may find it from the changeable values page of MODE SENSE (10) command.

Unit length is defined on media specific. A logical unit may change the value when media is changed.

Expected time of Group3 timeout has following three exceptions.

Exception 1: Initial OPC time

Exception 2: Sync cache time

Exception 3: Power state transition time to Active state

Initiator may control the occurrence of these exceptions by command e.g. SEND OPC INFORMATION command and SYNCHRONIZE CACHE command. And the occurrence of these exceptions is rare case. So it is not necessary to treat these exceptions as error.

If Group 3 timeout is supported, G3tout bit of VERIFY (10) command shall be supported as described in 14.47, "VERIFY (10) command" on page 525.

4.1.8.5.2 Trace time for requested sectors

Group 3 time unit value shows the minimum time of operation when the transfer length field is set to 1. If transfer length is larger than 1, Expected time is increased to reflect the transfer length of the command. e.g., in case of 1X CLV of DVD media, read operation takes 1.48msec/sector. If Group 3 time value is 3 sec. And transfer length is 160, Expected time is 3.24 sec. ($=3+0.00148*(160-1)$).

The transfer length field value of usual READ (12)/WRITE (12) command is assumed 32 or less. The trace time for the requested sectors of usual READ (12)/WRITE (12) command is very small comparing with Group 3 time unit value.

4.1.8.5.3 Exception 1: Time for the initial OPC

Optimum Power Calibration before a write operation takes several seconds. When OPC is performed, a logical unit may expand Expected time with extra time for the initial OPC. To avoid this exception, the Initiator should issue the SEND OPC INFORMATION command with DoOpc = 1.

Expected time with OPC = time for the initial OPC + Expected time

A logical unit should not perform very long internal later OPC during real-time stream recording at the WRITE (12) command with Streaming=1. A WRITE (10) command or WRITE (12) command with Streaming=0 and SEND OPC INFORMATION command with DoOpc = 1, the device may perform internal OPC later if necessary. The Initiator should issue the SEND OPC INFORMATION command with DoOpc = 1 when Real Time Stream Recording is paused.

If the logical unit reports CHECK CONDITION status with sense bytes SK/ASC/ASCQ set to NOT READY/LOGICAL UNIT NOT READY/LONG WRITE IN PROGRESS to avoid the timeout of WRITE (12) command with Streaming=1 due to insufficient buffer capacity, this exception does not occur. This OPC delay is hidden by this operation. However, it is not recommended to use this operation for the internal later OPC.

4.1.8.5.4 Exception 2: Sync cache time

If a logical unit has write data in buffer, when the logical unit receives READ (12) command with Streaming=1 or VERIFY (10) command with G3tout=1, the logical unit shall write the data in buffer. Then the logical unit shall read the specified blocks. In this case, additional Expected time for Sync cache is added to the Expected time for READ (12) command with Streaming=1 and VERIFY (10) command with G3tout=1.

- Expected time for Sync cache = Group3 time unit + write time for buffered sectors
- Expected time with Sync cache = Expected time for Sync cache + Expected time

Initiator may assume the Expected time for Sync cache via READ BUFFER CAPACITY command. e.g., if a logical unit has 2M bytes buffer, the logical unit may have about 60 ECC blocks of write data in buffer. In case of 1X CLV of DVD media, Expected time for Sync cache is 4.42 sec (= 3 + 0.00148*(960-1))

To avoid this exception, Initiator should issue SYNCHRONIZE CACHE command.

The logical unit shall report the buffer size by Length of Buffer field of Table 282 – READ BUFFER CAPACITY data when Block bit of CDB = 0 on page 381 if Group3 bit in the Timeout Feature (0105h) is set to 1 and the Timeout Feature (0105h) is current.

4.1.8.5.5 Exception 3: Power state transition time to Active state

When a logical unit is in Idle state or Standby state, the logical unit needs a few seconds to be Active state before a operation. When Power state transition is performed, Logical unit may expand Expected time with extra time for the Power state transition.

- Expected time with Power state transition = time for the Power state transition + Expected time

To avoid this exception, Initiator should issue START/STOP UNIT command with Start = 1, LoEj = 0 and Power Condition = 0.

4.1.8.5.6 Relationship of Group 3 time unit and Unit length

The Expected time of the command termination is increased by Group 3 time unit when the transfer block length is increased by Unit length as shown in Figure 83. Changing Group 3 time unit causes big direct impact to Initiator software. Therefore, Group 3 time unit value shall not be changed with medium change. If adjustment of the Expected time of the command termination time on different media is necessary, different Unit length value for different media shall be used.

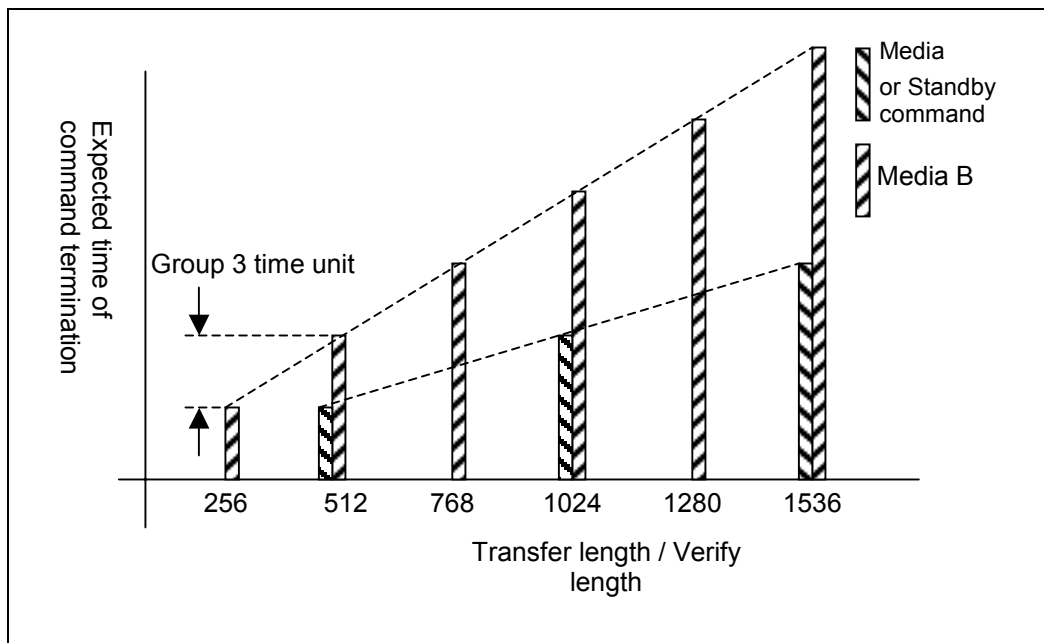

Figure 3 – Adjustment of Command Termination Time on Different Media**4.1.8.6 Recommended Timeout value handling**

The Group 1 Minimum Timeout field, the Group 2 Minimum Timeout field and the Group 3 Time unit field in the Timeout & Protect Mode Page (1Dh) may not be changeable. Even if the field is changeable, a logical unit may round up the Initiator specified value. Because the logical unit has its own minimum time to perform retry in a command. Initiator should check whether these fields are changeable or not by issuing MODE SENSE (10) command with Changeable Value of PC field prior to issue MODE SELECT (10) command. Also Initiator should check whether the selected value is accepted by issuing MODE SENSE (10) command with Current value after the MODE SELECT (10) command.

Specific timeout actions are included with each command description in clause 6.

4.1.9 Power Management

Power conditions permit the Initiator to modify the behavior of a MM Logical Unit in a manner that may reduce the required power. The Initiator may determine the current power state by issuing the GET EVENT STATUS NOTIFICATION command and requesting Power Management Events (See 6.7.2.3). Power conditions may be controlled by either the START STOP UNIT command or the Power Condition mode page. If both methods are being used on the same target/logical unit combination then any START STOP UNIT command's power condition request shall override the power condition mode page's power control. See the START STOP UNIT command description (6.45) and the MODE SELECT Power Condition mode page description (7.7) for more information. Table 7 shows the defined power conditions.

Table 7 – Power Conditions

Power Condition	Definition
Sleep	The lowest power consumption, with power applied, occurs in the Sleep condition. When in the Sleep condition a MM Logical Unit requires a WAKEUP task management function to be activated.
Standby	In the Standby condition a MM Logical Unit is capable of accepting commands, but media is not immediately accessible (e.g., the spindle is stopped).
Idle	In the Idle condition a MM Logical Unit is capable of responding quickly to media access requests. However, a MM Logical Unit in the idle condition may take longer, than in the active condition, to complete the execution of a command because it may have to activate some circuitry.
Active	In the Active condition a MM Logical Unit is capable of responding immediately to media access requests, and operations complete execution in the shortest time compared to the other power conditions.

No Logical Unit power condition change shall affect other devices connected to the physical interface. MM Logical Units that contain cache memory shall implicitly perform a SYNCHRONIZE CACHE command for the entire medium prior to entering any power condition that prevents access the media (e.g., the spindle being stopped).

Power Management implementation details are given in Annex I.

4.2 CD Model

4.2.1 CD Media Organization

The CD device model is driven by the CD media organization and data formats. A CD medium is an 80mm or 120mm disc with a continuously recorded spiral track beginning near a diameter of 50mm and spiraling outward to a diameter near 78mm or 118mm.

4.2.2 Recorded CD Media Structure

4.2.2.1 The CD Frame Structure

Data is recorded in a continuous stream of Small Frames. Each byte of a Small Frame is encoded with an 8 bit to 14bit modulation (EFM) code. Three merging bits are appended. The merging bits are chosen to provide minimum low-frequency signal content and optimize phase lock loop performance. Each Small Frame consists of 588 EFM bits (see Table 8). Small Frame is defined in clause 3.1.

Table 8 – Small Frame layout and definition

1 synchronization pattern (24 + 3 bits)	1 byte of Sub-channel data (14 + 3 bits)	12 bytes of main channel data (12 x (14 + 3) bits)	4 bytes of CIRC code (4 x (14 + 3) bits)	12 bytes of main channel data (12 x (14 + 3) bits)	4 bytes of CIRC code (4 x (14 + 3) bits)
588 bits					

A CD frame consists of 98 contiguous Small Frames. This yields $24 \times 98 = 2352$ bytes of main channel data per frame and 98 bytes of Sub-channel data per CD frame. A recorded CD is a succession of CD frames. For audio, the bounds of a Frame are defined by the Sub-channel bytes. For data, the bounds are determined by the sync bytes in the main channel data.

The 98 Sub-channel bytes are separated into 2 bytes of synchronization and 96 bytes of data. Each CD frame begins with the first Sub-channel sync byte and ends with the 96th Sub-channel data byte. A CD frame is constructed from Small Frames as shown in Table 9. This is a logical representation since Small Frames are physically interleaved. This means that precise CD frame boundaries do not exist.

Table 9 – CD Frame Structure from Small Frames

F R A M E N	.	.	.
	.	.	.
	Small Frame 94	Sub-channel Data Byte 92	24 bytes main channel data
	Small Frame 95	Sub-channel Data Byte 93	24 bytes main channel data
	Small Frame 96	Sub-channel Data Byte 94	24 bytes main channel data
	Small Frame 97	Sub-channel Data Byte 95	24 bytes main channel data
	Small Frame 98	Sub-channel Data Byte 96	24 bytes main channel data
F R A M E N+1	Small Frame 1	Sub-channel Sync Byte 1	24 bytes main channel data
	Small Frame 2	Sub-channel Sync Byte 2	24 bytes main channel data
	Small Frame 3	Sub-channel data byte 1	24 bytes main channel data
	.	.	.
	.	.	.
	Small Frame 97	Sub-channel data byte 95	24 bytes main channel data
	Small Frame 98	Sub-channel data byte 96	24 bytes main channel data
F R A M E N+2	Small Frame 1	Sub-channel sync byte 1	24 bytes main channel data
	Small Frame 2	Sub-channel sync byte 2	24 bytes main channel data
	Small Frame 3	Sub-channel data byte 1	24 bytes main channel data
	Small Frame 4	Sub-channel data byte 2	24 bytes main channel data
	Small Frame 5	Sub-channel data byte 3	24 bytes main channel data
	.	.	.
	.	.	.

4.2.2.2 Sub-channel

Each non-sync byte of Sub-channel is labeled according to bit position, See Table 10.

Table 10 – Sub-Channel byte layout

Small Frame Sub-channel Byte							
P	Q	R	S	T	U	V	W
Bit 7	Bit 6	Bit 5	Bit 4	Bit 3	Bit 2	Bit 1	Bit 0

Over the 98 Small Frames, the Sub-channel is separated into bytes associated with the Sub-channel letter. The Sub-channel sync bytes are not a part of Sub-channel data, so there are 96 bytes of Sub-channel. e.g., the P Sub-channel is separated into bytes as shown in Table 11.

Table 11 – P-Sub-Channel Layout

Small Frame	P Bit	P Byte
1	SYNC 0	-
2	SYNC 1	-
3	7	0
4	6	
5	5	
6	4	
7	3	
8	2	
9	1	
10	0	
11	7	1
12	6	
13	5	
14	4	
15	3	
16	2	
17	1	
18	0	
•	•	•
•	•	•
•	•	•

•	•	•
•	•	•
•	•	•
83	7	10
84	6	
85	5	
86	4	
87	3	
88	2	
89	1	
90	0	
91	7	11
92	6	
93	5	
94	4	
95	3	
96	2	
97	1	
98	0	

The byte construction for other (Q – W) Sub-channels is identical.

P and Q Sub-channels provide information about the recording.

R-W Sub-channel is defined only for audio tracks. When used, it carries line graphics, MIDI Control, or text. In that case, specific formatting of the resulting data defines the meaning. Consult the appropriate format documents. For data tracks, R-W sub-channels shall be set to zeros.

4.2.3 Physical Track Topology: Single Session Disc

CD players and readers follow the physical track by following the path of recorded EFM data. When there is no EFM data, the player/reader is unable to follow the physical track.

The physical track is divided into 3 logical entities from the inner radius:

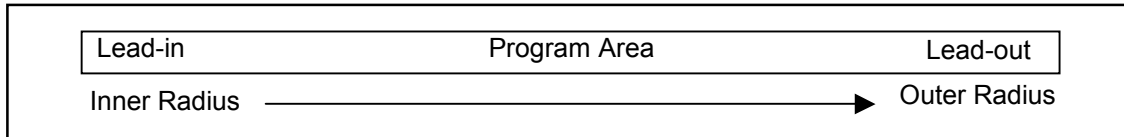

Figure 4 – Single Session disc

LEAD-IN – The Lead-in is a zone of protection from unrecorded areas near the disc center. The Lead-in also contains the table of contents (TOC) for the disc's Program Area.

PROGRAM AREA – This is also known as the user area of the disc. e.g., on an audio CD, this is where the music is recorded.

LEAD-OUT – The Lead-out is a zone of protection from unrecorded areas toward the disc's outer edge.

4.2.4 Physical track topology – Multi-Session Disc

4.2.4.1 Sessions

A Session is the recorded sequence: Lead-in, program area, Lead-out. The multi-session allows a single disc to have several concatenated sessions.

CD-ROM devices are not typically capable of reading through unrecorded areas on the medium. The CD-ROM device needs EFM data in order to find and stay in the physical track. This means that to ensure that a CD-ROM Logical Unit is capable of accessing all areas of a Program Area, the Program Area needs the protection zones of Lead-in and Lead-out. On a recorded disc, sessions may appear as shown in Figure 5.

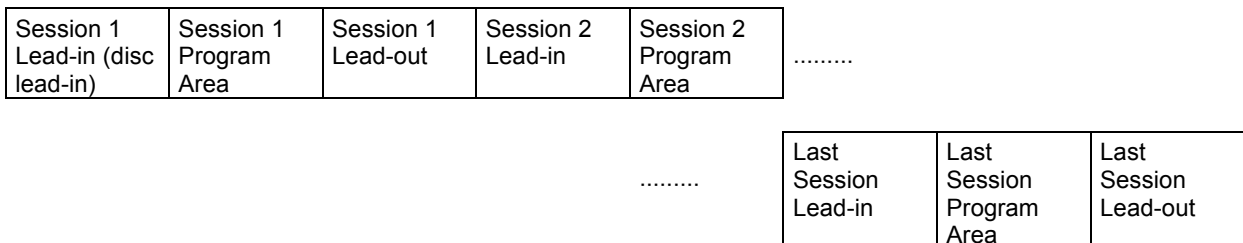

Figure 5 – Multi-Session Recorded Disc

In order to assure readability by CD-ROM Logical Units, the recording system should always close the session with the most recently added program area before attempting interchange.

Additional information is needed in order to locate all of the program areas. This is accomplished by using Mode 5 Q in the Lead-in areas.

4.2.4.2 Tracks

The Program Area of the disc is divided into logically separated areas called tracks. There shall be at least one track in the Program Area. There may be gaps between tracks, primarily to provide a zone of digital silence between audio program selections. P Sub-channel is reserved for identifying these transition areas between tracks. The normal value for P is 0. During a transition area, the value for P is 1.

4.2.4.3 Frame Addressing

CD was originally developed for playing digital audio that has two channels of 16-bit samples at 44.1KHz. The number of frames per second of play is 75:

$$\begin{aligned} \text{bytes/Sample} * 44\ 100 \text{ Samples/second} &= 176\ 400 \text{ bytes/second, and} \\ 176\ 400 \text{ bytes/second} / 2\ 352 \text{ bytes/frame} &= 75 \text{ frames/second} \end{aligned}$$

Given this, CD frames are addressed in terms of audio play time, i.e., Minute, Second, and Frame (MSF). The traditional value of 60 seconds per minute is followed.

In all cases, when an address appears as part of the CD format, it is in MSF format using 2 bcd digits per time unit. This limits the time addressing on the disc to 99bcd minutes. The representation for a time based address is MM:SS:FF, where MM = minutes, SS = seconds, and FF = frames.

Addressing in the program area begins with 00:00:00. This advances up through the Lead-out.

The last frame in the Lead-in is 99:59:74 and decreases as the physical track is followed toward the center of the disc. The Lead-in is typically 3 to 4 minutes in length.

4.2.4.4 Q Sub-channel

Since an audio CD frame has no address field built into the main channel, the address is carried in the Q Sub-channel. Q Sub-channel may also carry information about the logical structure of the disc, disc identification, and music track identification. The general format of a Q Sub-channel record is shown in Table 12.

Table 12 – Q Sub-channel record format

Field name	Definitions
S0, S1	Sub-channel Synchronization
CONTROL	The Control Field has 4 bits that define the type of information in the frame: 00x0b = 2 audio channels without pre-emphasis 00x1b = 2 audio channels with pre-emphasis of 50/15 μs 10x0b = 4 audio channels without pre-emphasis 10x1b = 4 audio channels with pre-emphasis of 50/15 μs 01x0b = Data track, recorded uninterrupted 01x1b = Data track, recorded increment 11xxb = reserved xx0xb = digital copy prohibited xx1xb = digital copy permitted The bits of the control field (except for the copy bit) may change during a pause (X=00) of at least 2 seconds and during the Lead-in area only.
ADR	4 bits of identification for DATA-Q. This is also known as the Mode (ADR) Q.
DATA Q	72 bits of data
CRC	A 16 bit CRC for the Control, ADR, and DATA-Q Fields. On the disc the CRC bits are inverted. The remainder has to be checked at zero. Polynomial = $P(X)=X^{16}+X^{12}+X^5+1$

Because the sync bits and the two bytes of CRC are overhead, the valid Q information length is actually 10 bytes.

4.2.4.5 Q Sub-channel in the Program Area

4.2.4.5.1 Types of Q

During the program area 3 types of Q Sub-channel may be encountered, Mode-1 Q, Mode-2 Q, or Mode-3 Q.

4.2.4.5.2 ADR=1 (0001b) – Mode-1 Q

Mode 1 Q occupies at least 9 out of 10 successive CD frames. Mode-1 Q in the program area is also referred to as current position Q. The Mode-1 Q format during data and audio tracks is shown in Figure 6.

ADR	DATA-Q								
0001	TNO	INDEX	MIN	SEC	FRAME	ZERO	AMIN	ASEC	AFRAME

Figure 6 – Q Sub-channel Mode-1 Format recorded in Program Area

- TNO = 01 to 99bcd is the track number
- INDEX = 00 to 99bcd is the Index to TNO. An audio track may be divided into up to 99 sections, identified by a non-zero index. The first indexed area in a track shall be 01. Most audio discs have only one indexed area per track. The pre-gap is the part of a track-to-track gap that belongs to the following track. In a track's pre-gap, the track number is that of the following track and the INDEX is 00.
- MIN, SEC, FRAME = Is the relative time within the track encoded as 6 BCD digits. This is 00:00:00 at track start and advances through the track. During the pre-gap the time decreases.
- ZERO = 8 bits of zero (00000000b)
- AMIN, ASEC, AFRAME = Is the program area absolute time address expressed in 6 BCD digits.

4.2.4.5.3 ADR=2 (0010b) – Mode-2 Q

Mode-2 Q is optional. If Mode-2 Q is present, it shall occupy at least 1 out of each 100 successive frames. The Mode-2 Q data format is shown in Figure 7.

ADR	DATA-Q														
0010	N1	N2	N3	N4	N5	N6	N7	N8	N9	N10	N11	N12	N13	ZERO	AFRAME

Figure 7 – Q Sub-channel Mode-2 Format

The DATA-Q field is 52 bits long, organized as 13 nibbles (N1 – N13), each carrying a single BCD digit. The resulting BCD string is the Media Catalog Number (MCN). The catalog number does not change on a disc. In case no catalog number is encoded according to the UPC/EAN code, N1 – N13 are all zero, or Mode-2 may be deleted from the disc.

The ZERO field contains 12 bits of zero. (000000000000b)

AFRAME is as defined in Q Sub-channel Mode-1 (two BCD digits running from 00 to 74). During the Lead-in (TNO = 00), these 8 bits are zero.

4.2.4.5.4 ADR=3 (0011b) – Mode-3 Q

Mode-3 Q is optional. If Mode-3 is present, it shall occupy at least 1 out of 100 successive sub-coding blocks. Mode-3 is used to give a unique number to an audio track. This is done by means of the International Standard Recording Code (ISRC). If no ISRC is used, Mode-3 shall be deleted. During the Lead-in and Lead-out, Mode-3 is not present on the disc. The ISRC may only change immediately after the Track Number (TNO) has been changed. The Mode-3 data format is shown in Figure 8.

ADR	DATA-Q															
0011	I1	I2	I3	I4	I5	0	0	I6	I7	I8	I9	I10	I11	I12	ZERO	AFRAME

Figure 8 – Q Sub-channel, Mode-3 Format

The Country-Code is given in fields I1 through I2, the owner-code in fields I3 – I5, The year of recording in fields I6 – I7 and the I8 through I12 contain the serial number of the recording. The characters I1 – I5 are 6-bit cells, coded as shown in Table 13. The characters I6 – I12 are coded in 4 bit BCD numbers.

I1 – I12 define the ISRC.

The ZERO Field contains 4 bits of zero. (0000b)

AFRAME is defined in Q Sub-channel Mode-1 Q (two BCD digits running from 00 to 74).

Table 13 – ISRC 6 bit character codes (in hexadecimal)

CHAR	CODE	CHAR	CODE
0	00	I	19
1	01	J	1A
2	02	K	1B
3	03	L	1C
4	04	M	1D
5	05	N	1E
6	06	O	1F
7	07	P	20
8	08	Q	21
9	09	R	22
A	11	S	23
B	12	T	24
C	13	U	25
D	14	V	26
E	15	W	27
F	16	X	28
G	17	Y	29
H	18	Z	2A

4.2.4.6 Q Sub-channel in the Lead-out Area

Q Sub-channel in the Lead-out area is similar to Q Sub-channel in the program area. The differences are:

Mode-1 Q Sub-channel: TNO = AAh, INDEX = 01bcd

Mode-2 Q Sub-channel: No differences.

No other Q Sub-channel modes are allowed in the Lead-out area.

4.2.4.7 Q Sub-channel in the Lead-in Area

4.2.4.7.1 Types of Q

Q Sub-channel in the Lead-in area is referred to as the Table of Contents (TOC).

Three modes of Q are allowed in the Lead-in area: Mode-1 Q, Mode-2 Q, and Mode-5 Q.

4.2.4.7.2 Mode-1 Q

The Mode-1 Q format during the Lead-in is shown in Figure 9. TNO is always 00 during the Lead-in and ZERO is always 00 during the Lead-in. Variations of Mode-1 Q are defined by the value of POINT.

ADR	DATA-Q								
0001	TNO=00	POINT	MIN	SEC	FRAME	ZERO=00	PMIN	PSEC	PFRAME

Figure 9 – Q Sub-channel Mode-1 Format recorded in Lead-in

POINT = 01bcd – 99bcd is the track number of the track being defined.

MIN, SEC, FRAME = Running time in the Lead-in, encoded as BCD

PMIN, PSEC, PFRAME = Track start time, encoded as BCD

POINT = A0h

MIN, SEC, FRAME = Running time in the Lead-in, encoded as BCD

PMIN = Track number of the first track in the program area, encoded as BCD

PSEC = Program area format: 00h - CD-DA or CD-ROM

10h – CD-I

20h – CD-ROM-XA

PFRAME = 0

POINT = A1h

MIN, SEC, FRAME = Running time in the Lead-in, encoded as BCD

PMIN = Track number of the last track in the program area, encoded as BCD

PSEC, PFRAME = 0, 0

POINT = A2h

MIN, SEC, FRAME = Running time in the Lead-in, encoded as BCD

PMIN, PSEC, PFRAME = Start time of Lead-out, encoded as BCD

4.2.4.7.3 Mode-2 Q

Mode-2 Q Sub-channel is defined the same in the Lead-in, program area and Lead-out.

4.2.4.7.4 Mode-5 Q

Mode-5 Q Sub-channel provides additional information about CD-R and CD-RW recordings. The format of a Mode-5 Q Sub-channel is shown in Figure 10. TNO is always 00 during the Lead-in. Variations of Mode-5 Q are defined by POINT.

ADR	DATA-Q								
0101	TNO	POINT	MIN	SEC	FRAME	ZERO	PMIN	PSEC	PFRAME

Figure 10 – Q Sub-channel Mode-5 Format recorded in Lead-in

POINT = 01...40 (Audio only: This identifies a specific playback skip interval)

MIN, SEC, FRAME = Skip interval stop time in 6 BCD digits
 ZERO = 00
 PMIN, PSEC, PFRAME = Skip interval start time in 6 BCD digits

POINT = B0h (multi-session disc)

MIN, SEC, FRAME = the start time for the next possible session's program area. A final session is indicated MIN, SEC, FRAME = FFh:FFh:FFh or when the Mode-5 point B0 is absent.
 ZERO = the number of different Mode-5 pointers present.
 PMIN, PSEC, PFRAME = the maximum possible start time of the outermost Lead-out

POINT = B1h (Audio only: This identifies the presence of skip intervals)

MIN, SEC, FRAME = 00, 00, 00
 ZERO = 00
 PMIN = the number of skip interval pointers
 PSEC = the number of skip track assignments in POINT=B2, B3, and B4
 PFRAME = 00

POINT = B2h, B3h, B4h (Audio only: This identifies tracks that should be skipped during playback)

MIN = 01-99bcd, track number to skip upon playback
 SEC = 00-99bcd, track number to skip upon playback,
 00 if no skip track is specified
 FRAME = 00-99bcd, track number to skip upon playback,
 00 if no skip track is specified
 ZERO = 00
 PMIN = 00-99bcd, track number to skip upon playback,
 00 if no skip track is specified
 PSEC = 00-99bcd, track number to skip upon playback,
 00 if no skip track is specified
 PFRAME = 00-99bcd, track number to skip upon playback,
 00 if no skip track is specified

NOTE 4: Skip intervals are seldom written by recorders and typically ignored by readers.

POINT = C0h (Together with POINT=B0h, this is used to identify a multi-session disc)

MIN, SEC, FRAME = ATIP values from Special Information 1, ID=101 (See)
 ZERO = 00
 PMIN, PSEC, PFRAME = Start time of the first Lead-in area of the disc

4.2.4.8 CD Main Channel Block Formats

4.2.4.8.1 General Data Block Format

Although some are rarely used, there are 6 main channel frame formats defined. Audio blocks are recorded unmodified. Data blocks are given a synchronization field at the beginning of the block. The pattern is shown in Figure 11.



Figure 11 – Synchronization Field pattern

The synchronization field is followed by a 4 byte header defined in Table 14. After the sync pattern the remaining bytes of the data block are scrambled with a feedback mechanism. This is done with a 15-bit shift register fed back according to the polynomial $X^{15}+X+1$.

Table 14 – Sync Pattern Block Header

Header Offset	Header Byte	Content
0	Minute	Program area time of block, minute component (00-79 bcd)
1	Second	Program area time of block, second component (00-59 bcd)
2	Frame	Program area time of block, frame component (00-74 bcd)
3	Mode	Bits 1, 0 = Data Mode, Bits 7 -.5 = block indicator field, Bits 4 – 2 = Reserved. When Bits 7 – 5 = 000 indicates user data.

Mode byte Format is shown below:

- Bits 7, 6, 5 = 000 - User Data block
- = 001 - Fourth Run-in block
- = 010 - Third Run-in block
- = 011 - Second Run-in block
- = 100 - First Run-in block
- = 101 - Link block. Physical linking of EFM data
- = 110 - Second Run-out block
- = 111 - First Run-out block
- Bits 4, 3, 2 = 000 - Reserved
- Bits 1, 0 = 00 - Mode 0 Data
- = 01 - Mode 1 Data
- = 10 - Mode 2 Data
- = 11 - Reserved

4.2.4.8.2 Block Format for Audio

Audio is streamed, so only user data resides within the frame. See the READ CD command description for byte ordering.

4.2.4.8.3 Block Format for Mode 0 Data

Mode 0 is a rarely used format as it is zero filled in the entire user data area. Mode zero data (Table 15) has the following format.

Table 15 – Mode Zero Data Format

Byte Offset	Field Length	Content
0	12	Data Block Sync pattern
12	3	Block MSF address (BCD)
15	1	Data mode = 0
16	2 336	User data (each byte is zero)

4.2.4.8.4 Block Format for Mode 1 Data

Mode 1 data (Table 16) is most prevalent in CD-ROM applications. The sync pattern, header and user data are protected by a 32-bit CRC. Two additional layers of error correction, P and Q, collectively called Level 3 correction cover the header and user data. This is also referred to as Layered error correction (L-EC or C3).

Table 16 – Mode 1 Data Format

Byte Offset	Field Length	Content
0	12	Data Block Sync pattern
12	3	Block MSF address (BCD)
15	1	Data mode = 01
16	2 048	User data
2 064	4	CRC ($P = (X^{16} + X^{15} + X^2 + X^1) * (X^{16} + X^2 + X + 1)$) Bytes 0 – 2 063
2 068	8	Zero fill
2 076	172	P parity symbols
2 248	104	Q parity symbols

The coverage of the CRC is the sync pattern, Header, and the User Data.

The coverage of Level 3 P is Header, User Data, CRC, and the zero fill.

The coverage of Level 3 Q is Header, User Data, CRC, the zero fill, and the P parity.

4.2.4.8.5 Block Format for Mode 2 Data

4.2.4.8.5.1 Forms of Mode 2

Mode 2 data blocks have two types: formless and formed. Mode 2 formed blocks have two forms: form 1 and form 2.

4.2.4.8.5.2 Block Format for Mode 2 formless Data

The Mode 2 formless block format (Table 17) is rarely used. There is no defined CRC or additional correction.

Table 17 – Mode 2 formless block format

Byte Offset	Field Length	Content
0	12	Data Block Sync pattern
12	3	Block MSF address (BCD)
15	1	Data mode = 2
16	2 336	User data

4.2.4.8.5.3 Block Format for Mode 2 form 1 Data

The Mode 2 form 1 block format (Table 18) is regularly used in recorder applications and Video CD movies. The Mode 2 form 1 format is very similar to Mode 1 format. The differences are:

- The 8 zero fill bytes have been moved to between the header and user data as two copies of a 4 byte sub-header.
- The CRC, P-parity, and Q-parity do not cover the block header. This assures the ability of relocating data, including all parity symbols.

Table 18 – Mode 2 form 1 data format

Byte Offset	Field Length	Content
0	12	Data Block Sync pattern
12	3	Block MSF address (BCD)
15	1	Data mode = 2
16	4	Sub-header, first copy
20	4	Sub-header, second copy
24	2 048	User data
2072	4	CRC ($P = (X^{16} + X^{15} + X^2 + X^1) * (X^{16} + X^2 + X + 1)$) Bytes 16 – 2071
2076	172	P parity symbols
2248	104	Q parity symbols

The format of the sub-header is shown in Table 19.

Table 19 – Mode 2 Formed Sector Sub-header Format

Sub-Header Byte	Byte Name	Definition
0	File number	Identifies the file to which the block belongs
1	Channel number	Playback channel selection
2	Sub-mode	Bit 7: End-of-File
		Bit 6: Real-time block
		Bit 5: Form (0 = Form 1, 1 = Form 2)
		Bit 4: Trigger Block
		Bit 3: Data Block
		Bit 2: Audio Block (not traditional CD-DA audio)
		Bit 1: Video Block
3	Coding information	Bit 0: End-of-Record

4.2.4.8.5.4 Block Format for Mode 2 form 2 Data

Mode 2 form 2 data (Table 20) is regularly used in Video CD movies. The data is optionally covered by CRC within the last 4 bytes of the block.

Table 20 – Mode 2 form 2 data format

Byte Offset	Field Length	Content
0	12	Data Block Sync pattern
12	3	Block MSF address (BCD)
15	1	Data mode = 2
16	4	Sub-header, first copy
20	4	Sub-header, second copy
24	2 324	User data
2 348	4	Optional CRC Bytes 16 – 2 347

4.2.4.9 CD Recordable and CD ReWritable Media Structure

4.2.4.9.1 ATIP

An unrecorded CD-R or CD-RW media has no EFM available for locating the physical track in the traditional way of CD-ROM Logical Units. A blank CD-R/CD-RW is not smooth. It is pre-grooved with a built-in wobble for the purpose of defining the physical track.

The wobble is a 22.05kHz signal (at 1X) modulated with digital information. The information recorded within the pre-groove defines frames of 42 bits. This is known as Absolute Time In Pre-groove (ATIP, see Figure 12).

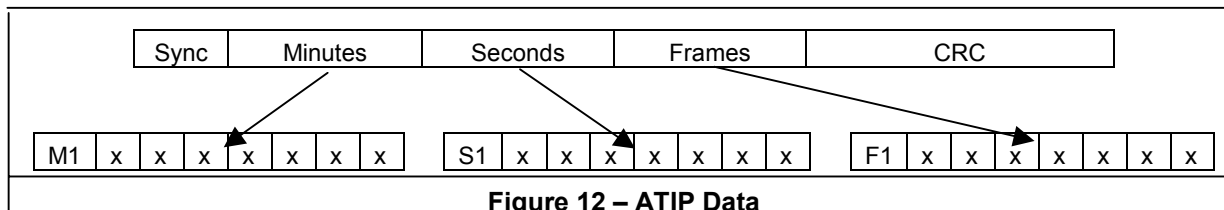

Figure 12 – ATIP Data

The area from any ATIP sync to the next ATIP sync is called an ATIP frame. Each ATIP frame defines the recording area for a CD sector. The information carried within an ATIP frame is 3 bytes labeled M, S, and F. The high order bit of each byte (M1, S1, F1) is used to identify the information contained within the remaining 21 bits. Specific information on capturing and decoding ATIP frame data is found in *CD Recordable System Description (Volumes 1 and 2)* and *CD ReWritable System*

Description (Volumes 1 and 2).

ATIP information types are listed in Table 21.

Table 21 – ATIP Information Types

M1, S1, F1	ATIP Type Name	ATIP Data Content
000b	Time Code	ATIP frame location
001b	Additional Information 1	Recording speed and additional capacity parameters
010b	Additional Information 2	Recording speed parameters
011b	Additional Information 3	Media identification
100b	Time Code	ATIP frame location
101b	Special Information 1	Application code, Disc Type
110b	Special Information 2	Start time of disc's lead-in
111b	Special Information 3	CD-R: Last Possible Start Time of last Lead-out when Special Information 1 is present in lead-in. CD-R: Start time of additional capacity when Additional Information 1 is not present in lead-in, but present in the PCA1 area. CD-RW: Last Possible Start Time of last Lead-out

4.2.4.9.2 ATIP Time Codes

Time codes are presented as MSF with each byte encoded in bcd. The M1, S1, and F1 bits (000b or 100b) are considered a part of the time code. The starting ATIP time code on the disc is typically larger than 95:00:00. As the pre-groove is followed from the inner radius, time codes increment by one frame per ATIP frame until 99:59:74 is reached. The next ATIP frame has time code 00:00:00 – the start of the program area. ATIP frame time codes continue incrementing by one frame until 99:59:00 is reached. If the disc has capacity remaining, the high order 4-bits of the minute field continues to increment past 9, while all other digits are held to bcd encoding. See Figure 13.

Start of pre-groove	> 95:00:00 ... 99:59:74	Inner Radius ↓ Outer Radius
Start of program area	00:00:00 ... 79:59:74 80:00:00 ... 99:59:74 A0:00:00 ...	
Maximum capacity for all CD-RW and older CD-R	...	
Last fully bcd encoded time code	A0:00:00 ...	

Figure 13 – Time Codes in CD-R and CD-RW Pre-groove

4.2.4.9.3 Special Information

Special Information types 1, 2, and 3:

- are present on all CD-R and CD-RW media,
- are interleaved between ATIP time code frames within the area that precedes the program area,
- do not appear before the MSF address in Special Information 2 (Start Time of Disc's lead-in).

Special Information 1 (SI1) includes:

- suggested write power,
- reference write speed,
- disc application code,
- a disc type bit (R = 0, RW = 1),
- a disc sub-type code (contains valid information only for CD-RW media),
- three presence bits for Additional Information 1, 2, and 3.

Special Information 2 (SI2) contains the ATIP time code that corresponds to the disc's lead-in address.

Special Information 3 (SI3) has 2 possible meanings:

- On media defined in *CD Recordable System Description – Volume 1* and *CD ReWritable System Description (Volume 1 and Volume 2)*, the ATIP time code that corresponds to the recommended disc's lead-out start address.
- On media defined in *CD Recordable System Description – Volume 2*, the recommended disc's lead-out stop address is calculated by adding the additional capacity indicated in Additional Information 1 to this ATIP time code value.

4.2.4.9.4 Additional Information

Additional Information 1 (AI1):

- a) appears on all recordable and rewritable media,
- b) on media as defined in *CD Recordable System Description – Volume 1* and *CD ReWritable System Description – Volume 1* AI1 is found in the disc lead-in.
- c) on media as defined in *CD Recordable System Description – Volume 2* AI1 is found in the 30 seconds prior to the disc lead-in,
- d) on media as defined in *CD Recordable System Description – Volume 1* AI1 it is also found in the disc lead-out area.

Additional Information 2 (AI2):

- a) on media as defined in *CD Recordable System Description – Volume 1* and *CD ReWritable System Description – Volume 1* AI2, is not defined,
- b) on media as defined in *CD Recordable System Description – Volume 2*, AI2 is found in the 30 seconds prior to the disc lead-in,
- c) on media as defined in *CD Recordable System Description – Volume 1*, AI2 is also found in the disc lead-out area.

Additional Information 3 (AI3):

- a) on media as defined in *CD Recordable System Description – Volume 1* and *CD ReWritable System Description – Volume 1* AI3 is not defined,
- b) on media as defined in *CD Recordable System Description – Volume 2* AI3 is found in the 30 seconds prior to the disc lead-in,
- c) on media as defined in *CD Recordable System Description – Volume 1* AI3 is also found in the disc lead-out area.

4.2.4.10 Blank Media Structure

4.2.4.10.1 CD-R Volume 1 and CD-RW

There are two additional areas prior to the disc Lead-in (Figure 14), the Power Calibration Area (PCA), and the Program Memory Area (PMA).

The Power Calibration Area is present only for CD-R and CD-RW media for the purpose of write power calibration. The PCA is divided into two areas: the test area and the count area. The test area is divided into 100 calibration partitions. The count area is an accounting area for recording usage of the test area.

The Program Memory Area is present only for CD-R and CD-RW media for the purpose of accounting for the usage of user data areas on the medium. This information is contained only within the Sub-channel of the PMA frames. The main channel content is not defined within the PMA.

Update the PMA means to update the PMA on the disc or to update the PMA Cache that shall be written to the PMA on the disc prior to the removing the disc from the Logical Unit. PMA Caching is vendor specific.

PCA	PMA	Lead-In	Program Area	Lead-out
-----	-----	---------	--------------	----------

Figure 14 – CD-R Volume 1 and CD-RW Structure

4.2.4.10.2 CD-R Volume 2

High capacity CD-R media described in *CD Recordable System Description – Volume 2* has two PCAs. PCA1 is in the same location and has the same length as the PCA on CD-R volume 1 media. PCA2 begins after the last lead-out on the disc and is minimally the same size as PCA1. All other areas of CD-R volume 2 media have the same definitions as for CD-R volume 1 media.

PCA1	PMA	Lead-In	Program Area	Lead-out	PCA2
------	-----	---------	--------------	----------	------

Figure 15 – CD-R Volume 2 Structure

4.2.4.10.3 PMA Q Sub-channel

The PMA is a temporary TOC to be used as a disc is being recorded in increments. The format of the Q Sub-channel for PMA entries is similar to those in the Lead-in.

The PMA is recorded in groups of 10 frames called a PMA unity. If any of the frames in a unity is recorded, then all frames in the unity shall be recorded. A given PMA entry shall appear either 5 or 10 times within a unity.

Q Sub-channel in the PMA has the general form shown in Figure 16.

ADR	DATA-Q								
0001-0110	TNO	POINT	MIN	SEC	FRAME	ZERO	PMIN	PSEC	PFRAME

Figure 16 – PMA, Q Sub-channel

Mode-1 Q Sub-channel in the PMA is a TOC item:

TNO	=	00
POINT	=	Track number encoded as two BCD digits.
ZERO	=	00-09bcd is a label of the frame number in the PMA unity
MIN, SEC, FRAME	=	Track stop time in 6 BCD digits.
PMIN, PSEC, PFRAME	=	Track start time in 6 BCD digits.

Mode-2 Q Sub-channel in the PMA is a Disc Identification item (optional):

TNO	=	00
POINT	=	00
ZERO	=	00-09bcd is a label of the frame number in the PMA unity
MIN, SEC, FRAME	=	Disc identification as a 6 BCD digit number.
PMIN	=	00
PSEC	=	Sessions format: 00 – CD-DA or CD-ROM, 10 – CD-I, 20 – CD-ROM-XA
PFRAME	=	00

Mode-3 Q Sub-channel in the PMA is a Skip track item (optional, audio only):

- TNO = 00
- POINT = 01-21bcd is the mode-3 index of this item
- ZERO = 00-09bcd is a label of the frame number in the PMA unity
- MIN = 01-99bcd track number to skip upon playback
- Each of the following: = 00 if no skip track is specified
- SEC, FRAME = 01-99bcd (each byte) track number to skip upon playback
- PMIN, PSEC, PFRAME

Mode-4 Q Sub-channel in the PMA is an unskip track item (optional, audio only):

- TNO = 00
- POINT = 01-21bcd is the mode-4 index of this item
- ZERO = 00-09bcd is a label of the frame number in the PMA unity
- MIN = 01-99bcd track number to unskip upon playback
- Each of the following: = 00 if no unskip track is specified
- SEC, FRAME = 01-99bcd (each byte) track number to unskip upon playback
- PMIN, PSEC, PFRAME

Mode-5 Q Sub-channel in the PMA is a skip interval item:

- TNO = 00
- POINT = 01-40bcd is the mode-5 index of this item
- ZERO = 00-09bcd is a label of the frame number in the PMA unity
- MIN, SEC, FRAME = Skip interval stop time in 6 BCD digits.
- PMIN, PSEC, PFRAME = Skip interval start time in 6 BCD digits.

Mode-6 Q Sub-channel in the PMA is an “unskip interval” item:

- TNO = 00
- POINT = 01-40bcd is the mode-6 index of this item
- ZERO = 00-09bcd is a label of the frame number in the PMA unity
- MIN, SEC, FRAME = Unskip interval stop time in 6 BCD digits.
- PMIN, PSEC, PFRAME = Unskip interval start time in 6 BCD digits.

4.2.4.11 Recording

Blank CD-R is not randomly writable. CD-RW is limited in its random write capability. Due to the interleaved nature of CD frames, blank media shall be recorded in groups of frames with linkage for appending new recording.

There are two methods for linking separate writes on CD-R or CD-RW:

Audio – Linkage occurs within a single frame time. This assures that locating the linkage frame by its Q at a later time is nearly impossible.

Data – Since it is necessary to locate exact boundaries of user blocks, additional padding is inserted around the linkage frame. The collection of the link block, the pad blocks, and the user blocks is called a Packet. The format of the packet is shown in Figure 17.

Link Block	Run-in Block 1	Run-in Block 2	Run-in Block 3	Run-in Block 4	User Data Blocks	Run-out Block 1	Run-out Block 2
------------	----------------	----------------	----------------	----------------	------------------	-----------------	-----------------

Figure 17 – Packet Format

Bits 5, 6, and 7 of the block's mode byte (see Table 22) uniquely identify blocks.

Table 22 – Block Identifier bits

Mode Byte Bits 7, 6, 5	Block
000	User Data
001	Run-in block 4
010	Run-in block 3
011	Run-in block 2
100	Run-in block 1
101	Link block
110	Run-out block 2
111	Run-out block 1

See 4.2.4.8 for a detailed definition of the Mode Byte. Main channel user data should be all zeros. Only entire packets may be rewritten on CD-RW media.

There are 2 types of recording on CD-R: Uninterrupted and Incremental. Incremental recording requires linking, whereas uninterrupted does not.

Disc At Once is the only type of uninterrupted recording and is a special case of Session At Once. The recording begins at the start of the Lead-in and stops only when the last block of the Lead-out is written. The PMA is not written. No linking is required.

There are 5 types of incremental recording:

Session At Once – The recording begins at the start of the Lead-in of the next session and stops only when the last block of that session's Lead-out is written. The PMA is constructed and written as a separate write action. Linking between sessions is required.

Reserve Track – User data is not necessarily written. The PMA is written for the purpose of defining a new track.

Track At Once – A single packet that includes the pre-gap of the track and all of the track's user data.

Variable Packet – A variable number of user blocks is written between data linkage blocks. A variable packet shall be a part of the user data area of a track.

Fixed Packet – A fixed number of user blocks is written between the user blocks. A fixed packet shall be a part of the user data area of a track.

4.2.4.12 The Track Descriptor Block

The Track Descriptor Block (TDB) is required for Track at Once or Packet recording. When the TDB is present, each block of the pre-gap of a track is a TDB. When a track is only reserved for Track At Once recording, recording of the TDB is deferred until the track data is written. When a track is reserved for either sort of packet recording, the TDB shall be written as a single packet upon reservation.

The TDB contains main channel information about the track recording and optionally contains a history of tracks that preceded the TDB.

The TDB begins with an 8-byte header (Table 23). The TDB header is followed by one or more Track Descriptor Units (TDU) (Table 24).

Table 23 – Track Descriptor Block (TDB) header

Bit	7	6	5	4	3	2	1	0
Byte								
0	54h (ASCII "T")							
1	44h (ASCII "D")							
2	49h (ASCII "I")							
3	Pre-gap Length encoded BCD							
4								
5	Reserved							Current
6	Lowest Track Number Listed (BCD)							
7	Highest Track Number Listed (BCD)							
8	One or more Track Descriptor Unit(s) (TDU)							
:								
n								

Pre-gap length is given in number of blocks.

The Current bit, when set to 1, indicates that only the TDU for the current track is present. When set to zero, indicates that a TDU for tracks with numbers smaller than or equal to the current track, are present.

Table 24 – Track Descriptor Unit (TDU) Format

Bit	7	6	5	4	3	2	1	0	
Byte									
0	Track Number (BCD)								
1	Recording method								
2	(MSB)	Fixed Packet Size in blocks (BCD)						(LSB)	
3									
4									
5	Reserved								
...	Reserved								
15	Reserved								

Recording method is coded as shown in Table 25.

Table 25 – Recording Method

Code	Recording Method
00h	Audio track written TAO
80h	Data track written TAO
90h	incrementally written data track, variable packets
91h	incrementally written data track, fixed packets

Fixed Packet size is filled with FFFFFFFh whenever the recording method is not fixed packet.

4.2.5 High Speed CD-RW media recording

High speed CD-RW is defined in System Description ReWritable Compact Disc Systems, part III Volume 2: CD-RW (Orange Book part III, Vol. 2). High Speed CD-RW recording speed ranges are from 4x to 24x recording and also allows CAV recording. Newer versions of this media (speeds greater than 10x) are referred to as Ultra-Speed CD-RW. Upon CAV recording, write speed needs to be set for each track. If the Logical Unit is not capable of recording continuous track in CAV, then the Logical Unit shall use CLV mode with initial speed of CAV recording. e.g., if the 4x-10x CAV

recording is attempted for TAO mode, but the Logical Unit does not support CAV for TAO mode, then the Logical Unit shall choose 4x CLV recording for that track. This condition is not considered as an error.

It may not be possible to record High speed CD-RW media using Logical Units that comply with only Orange Book Part 3 volume 1. Upon write attempt to the High speed CD-RW media using Orange Book Part 3 volume 1 complying Logical Unit, some Logical Units return CHECK CONDITION Status and set SK/ASC/ASCQ values to either ILLEGAL REQUEST/WRITE PROTECTED or MEDIUM ERROR/NO SEEK COMPLETE. The recommended SK/ASC/ASCQ values for this case are ILLEGAL REQUEST/CANNOT WRITE MEDIUM – INCOMPATIBLE FORMAT.

In order to minimize the impact to legacy CD-R/RW Logical Units and software, the SET CD SPEED Command been modified. SET STREAMING Command and GET CONFIGURATION command for CD-R/RW implementation are defined.

Command Sequence example:

Upon media insertion, Initiator issues READ TRACK INFORMATION Command to find the next writable address. The GET CONFIGURATION Command may be used to identify the Logical Unit's capability for the mounted media.

Initiator then issues either SET CD SPEED Command or SET STREAMING Command for the track to be recorded. Also the Initiator sets an appropriate Write Parameters, and ready to write data.

4.2.6 CD Audio error reporting

Audio play commands (PLAY AUDIO (10), PLAY AUDIO (12), PLAY AUDIO MSF) with the immediate bit set in the audio control mode page return status as soon as the command has been validated (that may involve a seek to the starting address). The playback operation continues and may complete without notification to the Initiator. Error termination of audio operations shall be reported to the Initiator by returning CHECK CONDITION STATUS to the next command (except for REQUEST SENSE, INQUIRY, GET CONFIGURATION, and GET EVENT STATUS NOTIFICATION). The deferred error sense data is used to indicate that the error is not due to the current command.

The status of the play operation may be determined by issuing a REQUEST SENSE command. If SK is set to NO SENSE, and the ASC is set to NO ADDITIONAL SENSE DATA, then the ASCQ value should contain audio status as shown in Table 426.

4.2.7 CD ready condition/not ready condition

The ready condition occurs after a disc is inserted and the Logical Unit has performed its initialization tasks. These tasks may include reading the Table of Contents from the media. Table 26 defines the Not Ready Error reporting for each command. A not ready condition shall occur only for the following reasons:

- a) There is no medium mounted.
- b) The Logical Unit is unable to load or unload the medium.
- c) The Logical Unit is unable to recover the Table of Contents.
- d) The Target is unable to select the Logical Unit.
- e) As otherwise described in the command operation.

Table 26 – Not Ready Error Reporting (by command)

Command Name	Op Code	Return Not Ready Status	Command Name	Op Code	Return Not Ready Status
BLANK	A1h	Yes	READ TOC/PMA/ATIP	43h	Yes
CLOSE TRACK/SESSION	5Bh	Yes	READ TRACK INFORMATION	52h	Yes
SYNCHRONIZE CACHE	35h	Yes	RECEIVE DIAGNOSTIC RESULTS	1Ch	No
FORMAT UNIT	04h	Yes	RELEASE	17h, 57h	No
GET CONFIGURATION	46h	No	REPAIR TRACK	58h	Yes
GET EVENT STATUS NOTIFICATION	4Ah	No	REPORT KEY	A4h	Yes
GET PERFORMANCE	ACh	No	REPORT LUNS	A0h	No
INQUIRY	12h	No	REQUEST SENSE	03h	No
LOAD/UNLOAD MEDIUM	A6h	Yes	RESERVE	16h, 56h	No
LOCK/UNLOCK CACHE	36h	No	RESERVE TRACK	53h	Yes
LOG SELECT/SENSE	4Ch, 4Dh	No	REZERO UNIT	01h	Yes
MECHANISM STATUS	BDh	No	SCAN	BAh	Yes
MODE SELECT	55h, 15h	No	SEEK	2Bh	Yes
MODE SENSE	5Ah, 1Ah	No	SEND CUE SHEET	5Dh	No
PAUSE/RESUME	4Bh	Yes	SEND DIAGNOSTICS	1Dh	No
PLAY AUDIO	45h, A5h	Yes	SEND DVD STRUCTURE	BFh	No
PLAY AUDIO MSF	47h	Yes	SEND EVENT	A2h	Yes
PREFETCH	34h	Yes	SEND KEY	A3h	Yes
PREVENT ALLOW MEDIUM REMOVAL	1Eh	No	SEND OPC INFORMATION	54h	No
READ	28h, A8	Yes	SET CD SPEED	BBh	No
READ BUFFER	3Ch	No	SET READ AHEAD	A7h	Yes
READ BUFFER CAPACITY	5Ch	No	SET STREAMING	B6h	Yes
READ CAPACITY	25h	Yes	START STOP UNIT	1Bh	Yes
READ CD	BEh	Yes	STOP PLAY/SCAN	4Eh	Yes
READ CD MSF	B9h	Yes	TEST UNIT READY	00h	Yes
READ DISC INFORMATION	51h	Yes	VERIFY	2Fh, Afh	Yes
READ DVD STRUCTURE	ADh	Yes	WRITE	2Ah, AAh	Yes
READ FORMAT CAPACITIES	23h	No	WRITE BUFFER	3Bh	No
READ SUB-CHANNEL	42h	Yes	WRITE AND VERIFY	2Eh	Yes

4.2.8 Sensing support for CD-audio commands.

The preferred method of sensing support for CD audio is the implementation of the GET CONFIGURATION command (6.6). For legacy implementations, if any commands related to audio operations are implemented, then the PLAY AUDIO (10) command (6.15) shall be implemented to allow a method for the Initiator to determine if audio operations are supported. If a Logical Unit responds to a PLAY AUDIO (10) command with a transfer length of zero, with CHECK CONDITION STATUS, and setting the sense key to ILLEGAL REQUEST does not support audio play operations.

4.3 DDCCD Model

4.3.1 Introduction

The Double Density CD (DDCCD) Media Format is an extension of CD family whose capacity is more than double. This capacity is achieved by using a conventional 780 nm laser with a NA of 0.50 or 0.55, reduction of the track pitch (x 1.45), and reduced minimum pit size (x 1.33)

Table 27 – Realization of higher density

Parameter	Red Book CD	DDCCD	Factor
Track pitch (um)	1.60	1.10	1.45
Length of optical marks (3*n*11)	n*0.278	n*0.208	1.33
Program area radius (mm)	(120 mm disc) 25-37.5 (80 mm disc)	(120 mm disc) 24-37.5 (80 mm disc)	1.06
Total user bit rate/ Channel bit rate:	(CD-ROM <i>Mode 1</i>)	0.284 (CD-ROM <i>Mode 2</i>)	1.00

A DDCCD medium is an 80 mm or a 120 mm disc with a continuously recorded physical track beginning from a radius of 24 mm and spiraling outward to a radius 37.5 mm or 58 mm.

Like a conventional CD Logical Unit/Media there are three types of DDCCD Logical Unit/Media, Read Only (DDCCD-ROM), Write Once (DDCCD-R), and ReWritable (DDCCD-RW). The capacities of these media are the same. The DDCCD Media Format is not backward compatible with current CD devices

4.3.2 DDCCD Specifications

4.3.2.1 General

Comparing the new DDCCD specifications with those of the conventional CD, some major specifications are the same, such as the size of the disc. Other specifications indicate that some adaptations have to be made to the media production process of the DDCCD.

Error correction and physical addressing require some changes to the decoding/encoding equipment.

Shows some DDCCD parameters.

Table 28 – Main Parameters of DDCD

Parameter	DDCD-ROM	DDCD-R	DDCD-RW
Capacity (120 mm disc) [Mbytes]	1 300	1 300	1 300
Capacity (80 mm disc) [Mbytes]	400	400	400
Wavelength of laser diode [nm]	780	780	780
Reference NA [for read] [for write]	> 0.50	> 0.50 0.55	> 0.50 0.55
Data Bit length [um]	0.442	0.442	0.442
Channel Bit length [um]	0.208	0.208	0.208
Minimum Pit/Mark length [um]	0.62	0.62	0.62
Maximum Pit/Mark length [um]	2.29	2.29	2.29
Track pitch [um]	1.10	1.10	1.10
Sense of disc rotation seen from reading side	Counter clockwise	Counter clockwise	Counter clockwise
Thickness of the disc [mm]	1.2	1.2	1.2
User data per sector [bytes]	2 048	2 048	2 048
Error Correction Code	CIRC*	CIRC*	CIRC*
Layered ECC Constraint Length	1sector	1sector	1sector
Correctable burst error length [mm]	3.16	3.16	3.16
Scanning velocity at 1X speed [m/s]	0.90	0.90	0.90
Channel bit rate [Mbps]	4.3218	4.3218	4.3218
User data bit rate at 1X speed [k Bytes/s]	150	150	150

NOTE 5: CIRC* is different from the conventional CD. In the DDCD system, the delay parameter "D" of CIRC is extended from 4 to 7 to improve burst error correction ability in case of higher recording density. The maximum burst error correction ability of CIRC* is extended to 837 symbols.

4.3.2.2 Disc Structure

There are three address expressions used in the DDCD system; the Block address contained in the sector header (Physical Sector Number), Subcode-Q channel (Subcode frame time number), and the address referred to the blocks of the Initiator system (LBA: Logical Block Address).

The address used by the Initiator system starts from 0 to the end of the recorded information on the disc. LBA 0 shall correspond with the sector header address of D300h and the Subcode-Q address of 0:12:00:16 (0 hour, 12 minutes, 00 second, 16 frame). Only the Data Area is generally addressable by using LBA.

Sub-code Q areas are addressed in time based address. The representation for a time based address is H:MM:SS:FF, where H = hours, MM = minutes, SS = seconds, and FF = frames. Hour field is 1 digit. MM:SS:FF are 2 digits respectively. When the time based address includes the hours field selection between LBA and H:MM:SS:FF is indicated by the appropriate TIME bit.

One Hour is subdivided into 60 Minutes. One Minute is 60 Seconds. One Second is 75 frames. See Figure 18.

4.3.2.3 Single Session Disc

A Session is a recorded sequence that includes a Lead-in Area, Program Area, and Lead-out Area. The Lead-in / Lead-out Area is a guard area at inner / outer part of the disc. The Lead-in Area also contains the table of contents (TOC) for Program Area. The Program Area is also known as the user area of the disc.

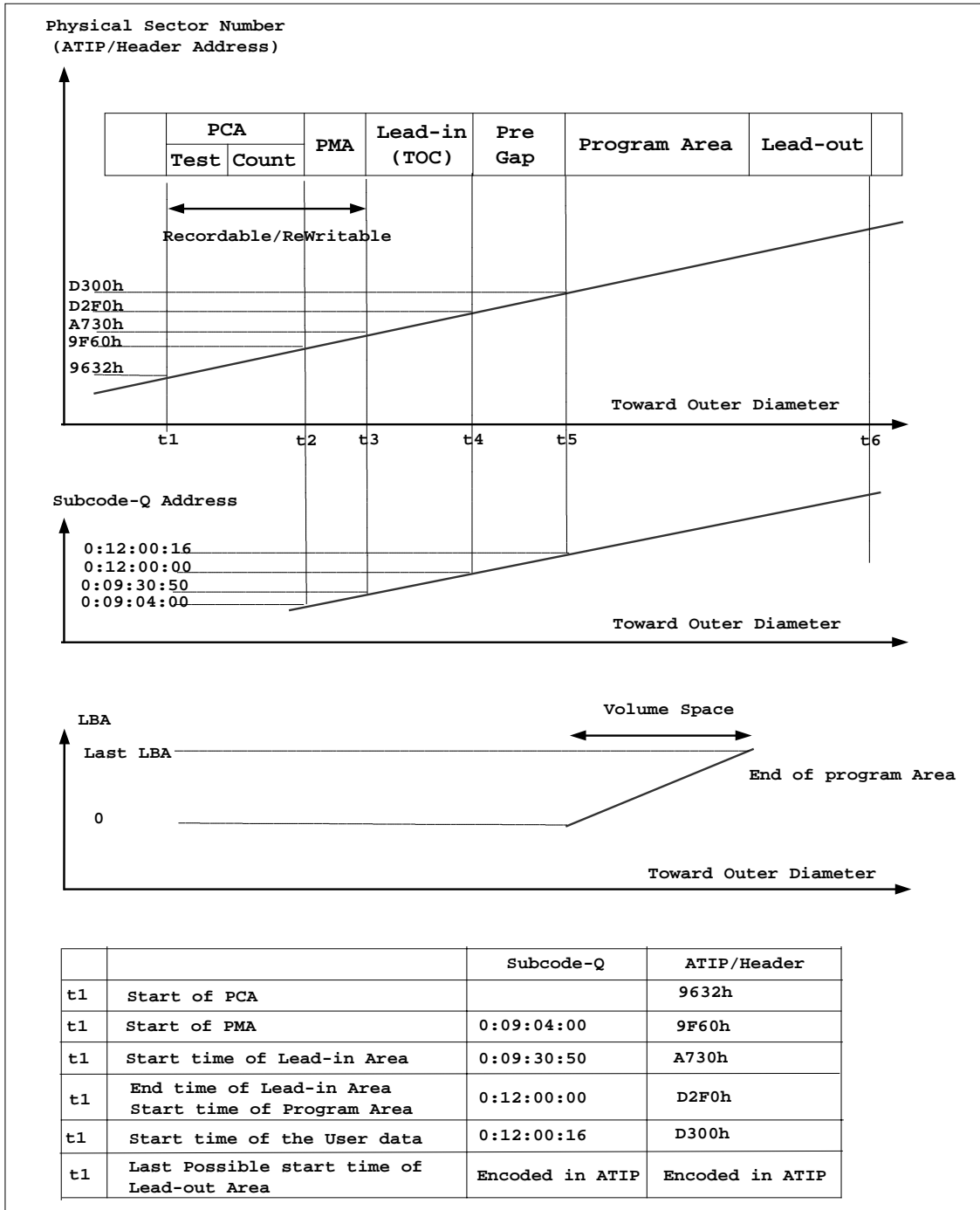

Figure 18 – Physical and Logical Layout of DDCD-ROM/R/RW

4.3.2.4 Multi-Session Disc

The multi-session allows a single disc to have several concatenated sessions. On a recorded disc, session may appear as shown in Figure 19.

DDCD read only Logical Units are not typically capable of reading through unrecorded areas on the medium. The DDCD read only Logical Unit needs EFM data in order to find and stay in the physical track. This is to ensure that a DDCD read only Logical Unit is capable of accessing all areas of a Program Area.

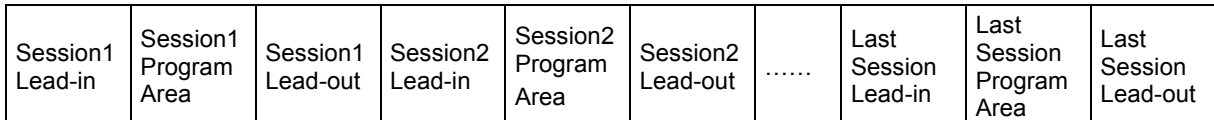

Figure 19 – Multi-Session Recorded Disc

In order to assure readability with DDCD read only Logical Units, the recording system shall always close the session before attempting interchange.

Additional information is needed in order to locate all of the program areas.

This is accomplished by using SubCode-Q Mode 5 in the Lead-in areas.

4.3.2.5 Physical Sector

The physical format defined by the DDCD media standard provides 2 352 bytes per sector. For computer data applications, 2 048 bytes is used for user data, 12 bytes for a synchronization field, 4 bytes for a sector address, 8 bytes for an additional information and 276 bytes – the auxiliary field – for Layered ECC.

4.3.2.6 Sector Structure

A Sector, called Mode2 Sector, shall consist of 2 352 bytes arranged with 12 Sync bytes, 4 Header bytes, 8 Sub-header bytes, 2 048 User Data bytes, 4 Error Detection Code (EDC) bytes, 172 P-Parity bytes, and 104 Q-Parity bytes. The User Data bytes are identified from 24th to 2071st. The Header shall consist of 3 bytes of Sector Address and 1 Mode byte. The Mode byte shall be 02h to indicate Mode 2 Disc Type.

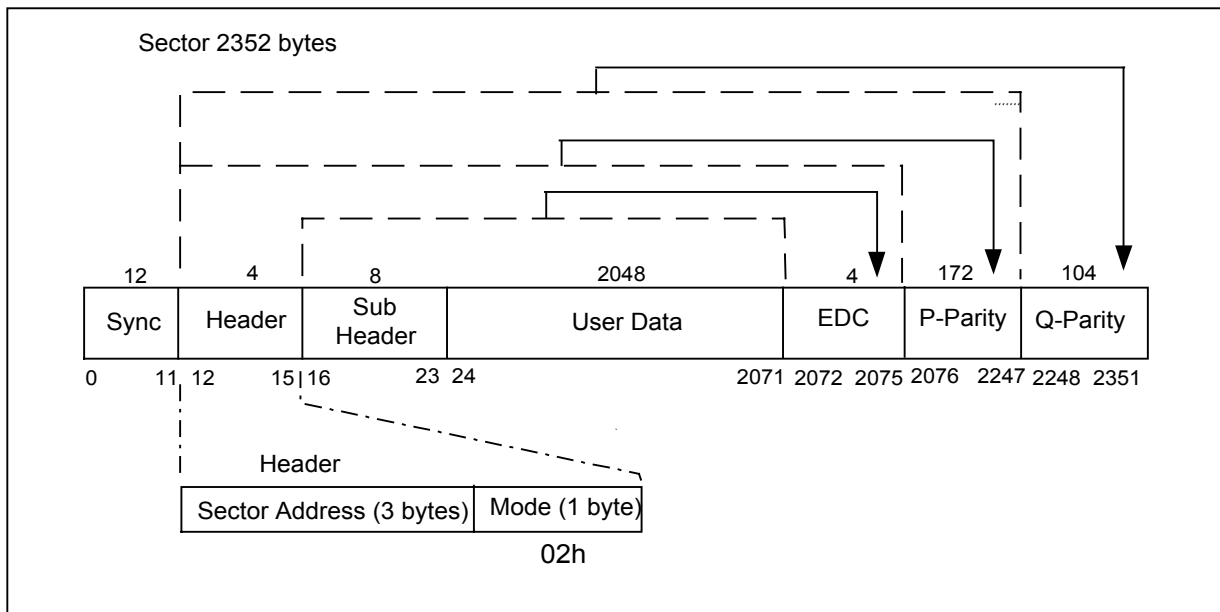

Figure 20 – Sector format Mode 2

The physical format of DDCD media uses smaller unit of synchronization than the other magnetic or

optical recording systems.

The basic unit of the data stream synchronization is a small frame. This is different from large frame (sector) as referred to in the HMSF unit. Each small frame consists of 588 bits. A sector on DDCD media consists of 98 small frames.

A DDCD small frame consists of:

1. 1 synchronization pattern (24+3 bits)
2. 1 byte of sub-channel data (14+3 bits)
3. 24 bytes of data (24 x (14+3) bits)
4. 8 bytes of CIRC code (8 x (14+3) bits) Total:588 bits.

Data, sub-channel and CIRC bytes are encoded to 14-bit codes according to the EFM table; then three merging bits are added. The merging bits are chosen to minimize DSV (Digital Sum Value) and provide DC free characteristics.

The data bytes of 98 small frames comprise the physical unit of data referred to as a sector. 98 small frames times 24 bytes per small frame equals 2 352 bytes of data per sector.

4.3.2.7 Sub-Channel Information Formats

The sub-channel 1 byte of each frame is assigned one bit for each of the 8 sub-channels, designated P, Q, R, S, T, U, V, W. Sub-channel P and R to W are all reserved and set to zero. All the sub-channel Q bits of a sector define the sub-channel Q information block. The sub-channel Q block consists of 98 bits, one bit from each small frame in a sector.

The format provides the information of the location and is defined as follows (See Figure 21):

1. 2-bits sub-channel synchronization field
2. 4-bits ADR field (defines the format)
3. 4-bits control field (defines the type of information in this sector)
4. 8-bits Track number
5. 8-bits index number
6. 28-bits reserved
7. 28-bits Absolute HMSF address (4-bits Hour, 8-bits Minutes, 8-bits Seconds, 8-bits Frames)
8. 16-bits CRC error detection code

ADR	TNO	INDEX	Reserved	AHOUR	AMIN	ASEC	AFRAME	CRC
-----	-----	-------	----------	-------	------	------	--------	-----

Figure 21 – Sub-code-Q Mode1 format recorded in Program Area

TNO = 01 to 99 is the track number in BCD

INDEX = 00.

AHOUR, AMIN, ASEC, AFRAME = the absolute time address expressed in 7 BCD digits.

4.3.2.8 DDCD Ready Condition/Not Ready Condition

The Ready Condition occurs after the disc is inserted and the Logical Unit has performed its initialization tasks. These tasks may include reading the lead-in information from the media. This “Ready” is different from and should not be confused with the ATA Ready Status. A CHECK CONDITION status shall be returned for the Not Ready Condition only for Commands that require or imply disc access.

A Not Ready Condition may occur for the following reasons:

- a) There is no disc.
- b) The Logical Unit is unable to load or unload the disc.
- c) The Logical Unit is performing an extended operation resulting from an immediate command such as FORMAT UNIT, BLANK, or CLOSE TRACK/SESSION.

The Logical Unit shall spin up and make the disc ready for media accesses when a disc is detected. After the Logical Unit becomes ready, it may return to the power state that it had when the previous medium was removed.

Any media access that occurs when the Logical Unit is not spinning shall spin the media up and not generate an error. Any media access that is requested while a deferred operation is in progress (i.e., writing from a write cache) shall not generate an error.

Accesses to the media may be satisfied from the Logical Unit's cache and may not require the media to be spinning.

Some commands are allowed to generate a CHECK CONDITION status with a NOT READY sense key and others are not.

4.3.2.9 DDCD Address Reporting Format (TIME bit)

Several (conventional) CD specific Commands may return addresses either in logical block address or in HMSF format. The READ SUBCHANNEL, and READ TOC/PMA/ATIP commands have this Feature.

Table 29 – TIME Address Format

Byte	Bit	7	6	5	4	3	2	1	0
0		H Field							
1		M Field							
2		S Field							
3		F Field							

A TIME bit in the CDB specifies the format. The TIME bit of zero requests that the logical block address format be used for the absolute address field.

A TIME bit of one requests that the HMSF format be used for these fields. The H, M, S, and F Fields are expressed as binary numbers. The value of the H field shall be zero for CD media and shall not exceed 2 for DDCD media. The value of the M field shall not exceed 99 for CD media and shall not exceed 59 for DDCD media. The value of the S field shall not exceed 59. The value of the F field shall not exceed 74.

4.3.2.10 Error Reporting

If any of the following conditions occur during the execution of a command, the DDCD Logical Unit shall return CHECK CONDITION status. The appropriate SK/ASC/ASCQ shall be set. The following list illustrates some error conditions and the applicable sense keys. The list does not provide an exhaustive enumeration of all conditions that may cause the CHECK CONDITION status.

Table 30 – Error Conditions and Sense Key

Condition	Sense Key
Invalid logical block address	ILLEGAL REQUEST
Unsupported option requested	ILLEGAL REQUEST
Attempt to read a blank block	ILLEGAL REQUEST
Attempt to play a data block as audio	ILLEGAL REQUEST
Device reset or medium change Since last command	UNIT ATTENTION
Self diagnostic failed	HARDWARE ERROR
Un-recovered read error	MEDIUM ERROR / HARDWARE ERROR
Recovered read error	RECOVERED ERROR
Overrun or other error that might be resolved by repeating the command	ABORTED COMMAND

In case of an invalid logical block address, the sense data information field shall be set to the logical block address of the first invalid address.

In case of an attempt to read a blank or previously unwritten block, the sense data information field shall be set to the logical block address of the first blank block encountered. The data read up to the error block shall be transferred.

4.3.2.11 Recording for DDCD media

There are several kinds of writing method of recording data in DDCD media. Session At Once, Track At Once, and Packet Writing are all used as methods of recording DDCD media. There is a special case of Session At Once recording known as Disc At Once. Packet Writing may be further classified into Variable Packet Writing and Fixed Packet Writing.

4.3.2.12 DDCD Recordable and DDCD ReWritable Structure

An unrecorded DDCD-R or DDCD-RW disc does not have an EFM to find the physical track in the traditional way of DDCD read only Logical Units. A blank DDCD-R or DDCD-RW has pre-groove and it has the built in wobble for the purpose of defining and finding the physical track.

The wobble is a 22.05KHz signal modulated with digital information. The position within the pre-groove is contained in each pre-groove frame of 42 bits. This is known as an Absolute Time In Pre-groove (ATIP).

The ATIP frame shall consist of 42 bits.

The format of the ATIP frame is defined in Table 31.

Table 31 – ATIP format

Number of bits	4	3	21	14
Bit position	1234	567	0011 11111111 22222222 8901 23456789012345678	23333333333444 90123456789012
Data	Sync	Discriminator	Physical frame address	CRC remainder

In the area that is expected to be the disc’s Lead-in Area, the additional information is interleaved between positional ATIP frames.

The additional information provided is:

1. First possible start address for disc Lead-in (TOC)
2. Last possible start address for disc Lead-out
3. Special information about recording permissions
4. Power and speed requirements for recording the medium
5. DDCD-R vs. DDCD-RW medium

DDCD-R/RW discs have two additional areas prior to the first Lead-in; the Power Calibration Area (PCA), and the Program Memory Area (PMA).

The Power Calibration Area (PCA) is present only in DDCD-R and DDCD-RW media for the purpose of write power calibration. The PCA is divided into two areas: the test area and the count area. The test area is divided into 1000 calibration partitions. The count area is a counting area for use of the test recording.

The Program Memory Area (PMA) is present only for DDCD-R and DDCD-RW media for the purpose of counting for the use of user data area on the medium. This information is contained only within the Subcode-Q channel of the PMA frames.

4.3.2.13 Packet Layout for DDCD

The layout of a Packet on DDCD media is shown in Figure 22. Each packet starts with Link block followed by three Run-in blocks. The User data blocks are placed directly after the Run-in blocks. Finally, three Run-out blocks are located following the User data blocks. In the case of Fixed packet writing, the size of each Packet in a Track is constant in length.

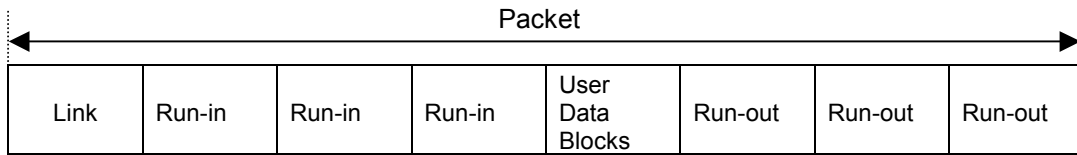

Figure 22 – Packet Layout

Blocks are uniquely identified by bit 5, 6, and 7 of the block's mode byte.

Table 32 – Block Identifier bits

Mode Byte, Bits 7, 6, 5	Block
000	User Data block
001	Third Run-in block
010	Second Run-in block
011	First Run-in block
100	Link block
101	Third Run-out block
110	Second Run-out block
111	First Run-out block

Figure 23 shows an example of the layout of a packet written Track.

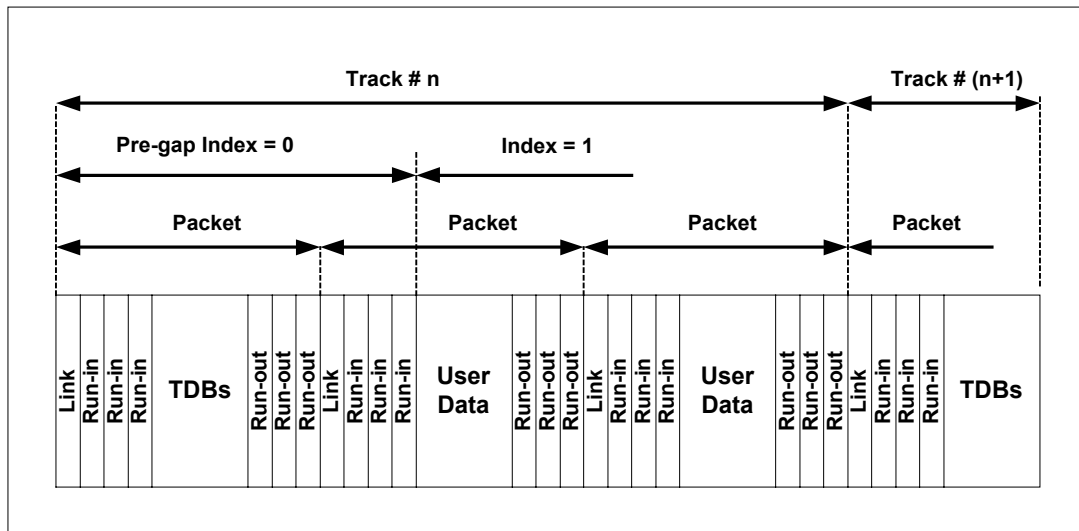

Figure 23 – Example of Packet written Track layout

4.4 DVD Model

4.4.1 General

The DVD Model is the description for the media types defined by the DVD Forum: DVD-ROM, DVD-RAM, DVD-R/RW, and media types defined by the DVD+RW Alliance: DVD+R and DVD+RW.

Like CD Logical Units/Media there are multiple types of DVD Logical Units/Media:

- a) Read Only (DVD-ROM)
- b) Recordable (i.e., write-once) (DVD-R and DVD+R)
- c) Re-Writable (DVD-RAM, DVD-RW, and DVD+RW).

The capacities of these different media vary. Some of these media also have the possibility of one or two sides, and independently, one or two layers per side.

4.4.2 Physical Media Characteristics

4.4.2.1 The Disc

DVD media is either 8 or 12 centimeters in diameter and separated into zones as shown in Figure 24.

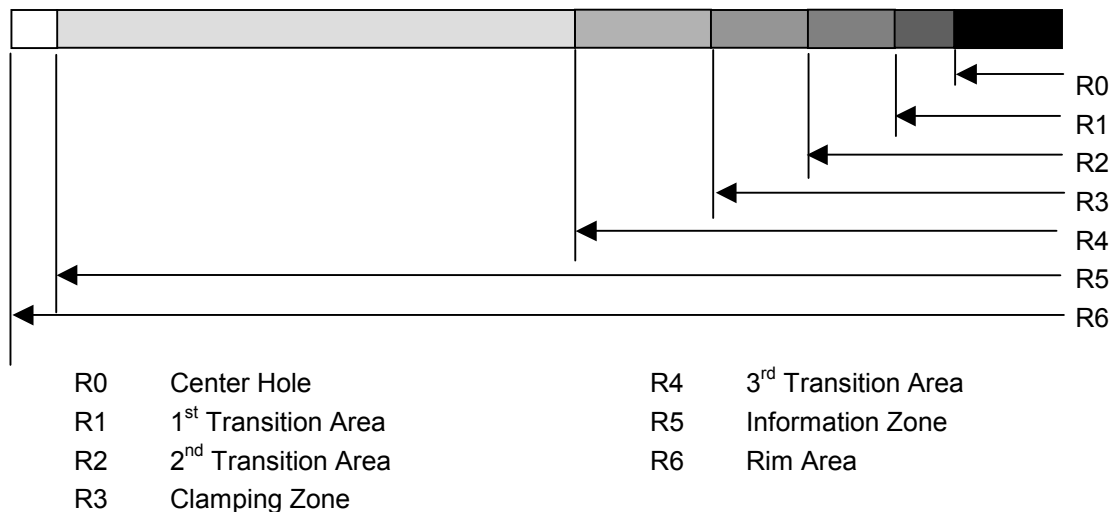

Figure 24 – The Zones of a DVD Medium

The Center Hole, 1st Transition Area, 2nd Transition Area, Clamping Zone, and 3rd Transition Area are all part of the alignment and clamping mechanisms. These areas have no direct involvement with the readable/writable areas of the medium.

The Information Zone is the area that actual recording may occur. It contains the lead-in, the data area, and the lead-out. This area typically begins at a radius of 22 millimeters. For 120-millimeter media, the information zone ends at a typical radius of 58.5 millimeters. For 80-millimeter media, the information zone ends at a typical radius of 38.5 millimeters.

The Rim Area is simply the area beyond the data groove. For 120-millimeter media, it typically ends at a radius of 60 millimeters. For 80-millimeter media, it typically ends at a radius of 40 millimeters.

4.4.2.2 Track (Groove) Structure

There are common properties among all of the DVD media types. In the simplest case (one-sided, single layer), the physical track structure is similar to CD: a continuous spiral. With respect to DVD, the word “track” is used in the same way that “groove” is used with CD media – a single word reference to a continuous spiral.

DVD provides the ability to use two focus depths in order that two tracks may be accessed from one side of the media. Additionally, media may be produced that contains recording on both sides of the media.

There are up to 4 possibilities for physical track structure:

- a) Single sided, single layer
- b) Single sided, dual layer
- c) Two sided, single layer,
- d) Two sided, dual layer.

In all cases, a track is one layer on one side of the media.

There are two types of track path for dual layer discs, either parallel or opposite. When the path is parallel, each track has its own Lead-in and Lead-out. When the path is opposite, the tracks share a single lead-in and a single lead-out and each layer has a transition zone called the middle area.

Figure 25 shows the single track case. Data zone sector numbering advances through the data zone with maximum data zone address at Lead-out start address – 1.

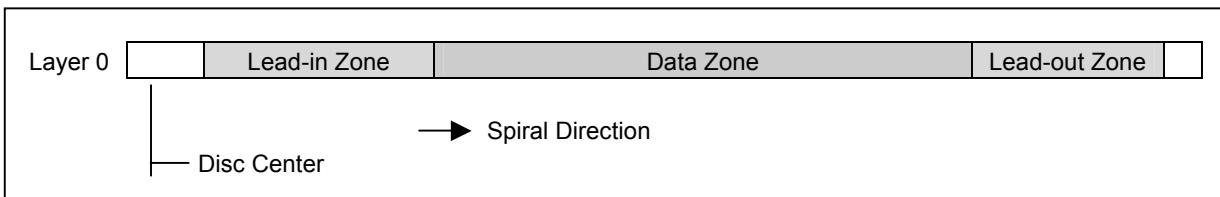

Figure 25 – Single Layer, Single Sided Disc

Figure 26 shows the parallel track path case. In each layer, data zone sector numbering advances through the data zone with maximum data zone address at Lead-out start address – 1. In this case, there are two distinct address spaces.

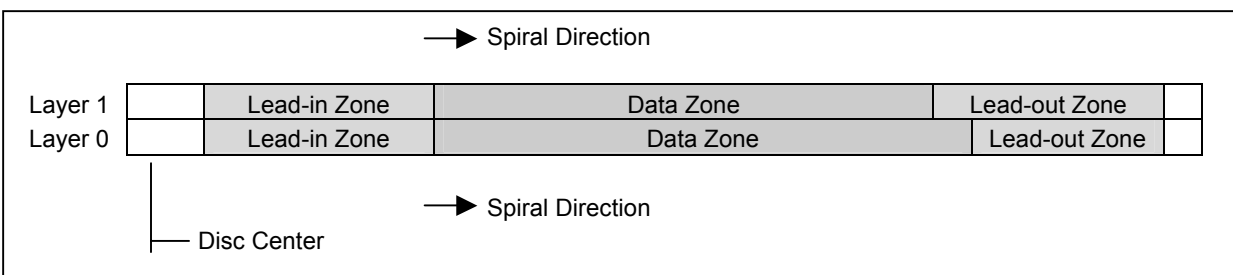

Figure 26 – Parallel Track Path Disc

Figure 27 shows the opposite track path case. Data zone sector numbering advances through the data zone stopping at the start of the middle zone for layer 0. The middle zones are constructed as an area where a layer reference change may occur and tracking direction changes. Sector numbering continues after the middle zone of layer 1 and continues to maximum data zone address at Lead-out start address – 1.

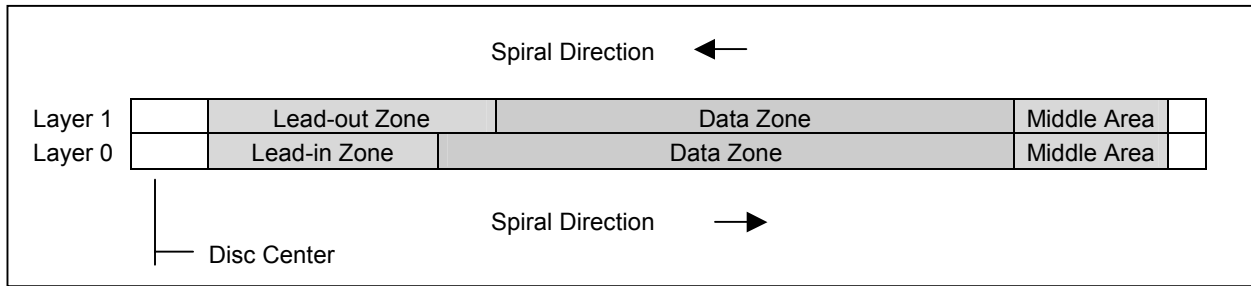

Figure 27 – Opposite Track Path Disc

4.4.2.3 ECC Blocks

4.4.2.3.1 General

When fully recorded, each track consists of an uninterrupted sequence of ECC blocks. Each ECC block contains 16 sectors of 2 048 data bytes each. Sectors are numbered with a 24-bit address. Numbering is linear and integral, beginning with zero. Sector zero exists only for the purposes of definition. No device has the need to access any sector with PSN smaller than 022F00h.

The general DVD ECC block is based upon the DVD-ROM standard.

Unlike CD media, adjacent sectors of DVD media are not necessarily interleaved. An ECC block consists of 16 sectors with headers, EDC symbols, and ECC symbols. Individual sector data are interleaved in order to minimize the effects of large media flaws. These ECC blocks are recorded serially on the medium.

In order to read and extract a single sector of data, the logical unit shall read the ECC block containing the sector, apply error correction to the ECC block, and de-interleave prior to extracting the data from the selected sector.

4.4.2.3.2 The Structure of the Data Sector

A DVD data sector contains 2 064 bytes, containing 2 048 bytes of main data and 16 bytes of additional information.

The logical layout of a DVD data sector is shown in Figure 28.



Figure 28 – Logical Layout of a DVD Data Sector

ID is a field that identifies the sector

IED contains 2 bytes of redundancy as an error detection code (EDC) for the ID field.

RSV is reserved and shall be recorded with zeros.

MAIN DATA contains 2 048 information bytes.

EDC contains 4 bytes of redundancy as an error detection code (EDC) for the entire sector.

The ID field is viewed as a 32-bit field as shown in Figure 29.

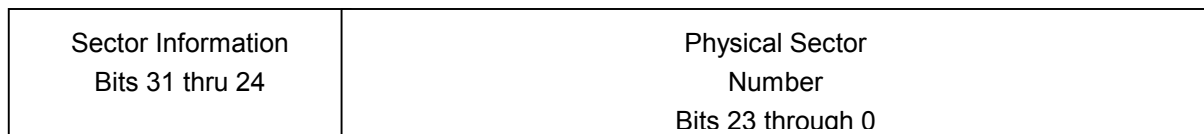

Figure 29 – ID Field

Sector Information varies for different DVD media types.

Physical Sector Number (PSN) The least significant 24 bits (bits 23 through 0) contains the PSN in binary notation. The PSN of the first Physical Sector of an ECC Block shall be an integral multiple of 16. In the data zone, the translation of LBA to PSN varies according to media.

4.4.2.3.3 The Structure of the ECC Block

A 2 064-byte sector is divided into 12 rows of 172 bytes each. Main data is scrambled similar to CD-ROM data scrambling. 16 sequential sectors are packed a single structure of 192 rows, each with 172 bytes. Error correction redundancy symbols are appended in order to produce 208 rows of 182 bytes each.

The organization of sector data and redundancy symbols within an ECC block is illustrated in Figure 30. Columnar symbols (Cx,y) are calculated and appended to rows, then Row symbols (Rx,y) are calculated and appended to columns. Columnar redundancy symbols are collectively known as Inner Parity (PI). Row redundancy symbols are collectively known as Outer Parity (PO).

		User Data					ECC Parity on Rows				
User Data		B0,0	B0,1	B0,2	...	B0,171	C0,0	C0,1	C0,2	C0,9
		B1,0	B1,1	B1,2	...	B1,171	C1,0	C1,1	C1,2	...	C1,9
		B2,0	B2,1	B2,2	...	B2,171	C2,0	C2,1	C2,2	...	C2,9
		B3,0	B3,1	B3,2	...	B3,171	C3,0	C3,1	C3,2	...	C3,9
	
		B190,0	B190,1	B190,2	...	B190,171	C190,0	C190,1	C190,2	...	C190,9
		B191,0	B191,1	B191,2	...	B191,171	C191,0	C191,1	C191,2	...	C191,9
ECC Parity		R0,0	R0,1	R0,2	...	R0,171	C192,0	C192,1	C192,2	...	C192,9
		R1,0	R1,1	R1,2	...	R1,171	C193,0	C193,1	C193,2	...	C193,9
		R2,0	R2,1	R2,2	...	R2,171	C194,0	C194,1	C194,2	...	C194,9
	
		R15,0	R15,1	R15,2	...	R15,171	C207,0	C207,1	C207,2	...	C207,9

Figure 30 – ECC Block Structure

Each of the 16 sectors of an ECC block has a unique PSN. The PSNs are sequential such that if the smallest is N, then N+1, N+2, N+3, ..., N+15 are also present in the ECC block. i.e., the sectors are sequenced in an intuitively correct way.

4.4.2.4 The Lead-in Area

The Lead-in Area has the general arrangement shown in Figure 31. Actual sizes and locations of each zone vary according to media type.

Lead-in Area	Initial Zone	Start of the spiral – zone of protection
	Area Specific to Media Type	Use varies according to media type
	Reference Code Zone	Read Calibration Area
	Buffer Zone 1	Separation Area
	Control Data Zone	Disc information - part of this is media specific
	Area Specific to Media Type	Use varies according to media type
Data Area	Data Zone	Viewed as user data area. Start PSN varies. Recordable media may implement a defect management.

Figure 31 – General Layout of Lead-in Area

For all DVD media types, the Control Data Zone consists of 192 ECC blocks. The information within each ECC block is identical. The structure of an ECC block within this zone is shown in Table 33.

Table 33 – Structure of Control Data ECC Block

Sector Number	Description
0	Physical Format Information
1	Disc Manufacturing Information
2	Reserved
...	
...	
...	
14	
15	

The format of the Physical Format Information (sector 0 of a Control Data ECC Block) is shown in Table 34.

Table 34 –Physical Format Information

Byte	Bit	7	6	5	4	3	2	1	0
0	Book Type					Part Version			
1	Disc Size					Maximum Rate			
2	Reserved	Number of Layers			Track Path	Layer Type			
3	Linear Density					Track Density			
4	Data Area Allocation								
5									
...									
...									
...									
15									
16	BCA Flag	Reserved							
17-2047	Medium Unique Data								

Book Type defines the source of the media specification. Book Type codes are shown in Table 35.

Table 35 – Book Type

Book Type Code	Associated Media	Book Type Code	Associated Media
0h	DVD-ROM	8h	Reserved
1h	DVD-RAM	9h	DVD+RW
2h	DVD-R	Ah	DVD+R
3h	DVD-RW	Bh	Reserved
4h	Reserved	Ch	Reserved
5h	Reserved	Dh	Reserved
6h	Reserved	Eh	Reserved
7h	Reserved	Fh	Reserved

Part Version specifies the media version.

Disc Size specifies the physical disc diameter as shown in Table 36.

Table 36 – Disc Size

Disc Size Code	Disc Diameter
0000b	12 centimeter
0001b	8 centimeter
0010b – 1111b	Reserved

Maximum Rate defines the maximum read data rate. Meaning of specific values is media dependent.

Number of Layers, Track Path, Layer Type, Linear Density, and Track Density specify media recording structure. See the appropriate media specification.

Data Area Allocation specifies bounds of the recorded/recordable area. This is specific to media type.

The BCA Flag identifies the presence/absence of a Burst Cutting Area.

Medium Unique Data contains data specific to the media type.

Disc Manufacturing Information (sector 1 of a Control Data ECC Block) is 2 048 bytes and has no standardized format.

4.4.3 DVD-ROM

4.4.3.1 Track Structure

DVD-ROM may have any of the 4 structures:

- a) single sided, single layer,
- b) single sided, dual layer,
- c) two sided, single layer,
- d) two sided, dual layer.

Two addresses are used: the Block address contained in the sector headers (Physical Sector Number), and the address used to reference the blocks from the Initiator system (LBA). The address used from the Initiator starts at 0 and progresses up through the end of the recorded information on the disc. LBA 0 shall correspond with the sector address of 030000h on DVD-ROM media. Only the Data Area is generally addressable using an LBA.

4.4.3.2 Sector Structure

DVD-ROM ECC block structure is consistent with the definition in 4.4.2.2. For DVD-ROM, the definition of the sector information part of the ID field is shown in Figure 32.

Sector Information ID bits 31 through 24						
31	30	29	28	27	26	25 24
Sector Format Type	Tracking Method	Reflectivity	Reserved	Zone Type		Data Type Layer Number

Sector Format Type	0b	Indicates CLV format
Tracking Method	0b	Indicates pit tracking
Reflectivity	0b	Indicates reflectivity exceeds 40%
	1b	Indicates reflectivity is less than or equal to 40%
Reserved	0b	
Zone Type	00b	When sector is in Data Zone
	01b	When sector is in Lead-in Zone
	10b	When sector is in Lead-out Zone
	11b	When sector is in Middle Zone
Data Type	0b	Indicates read-only data
Layer Number	0b	When sector is in layer 0
	1b	When sector is in layer 1

Figure 32 – ID Field for DVD-ROM

4.4.3.3 The Lead-in

The DVD-ROM lead-in structure is consistent with the structure shown in Figure 31. Table 37 shows the lead-in structure specific to DVD-ROM.

Table 37 – DVD-ROM Lead-in Structure

Starting PSN	Disc Area
22FA0h	Initial Zone All 00h
2F000h	Reference Code Zone
2F020h	Buffer Zone 1 All 00h
2F200h	Control Data Zone (192 ECC Blocks)
2FE00h	Buffer Zone 2 All 00h
30000h	Data Area
.	
.	

DVD-ROM is consistent with the general structure of the Control Data ECC Block as shown in Table 33 and the Common Part of the Physical Format Information as shown in Table 34.

Table 38 shows the Data Allocation Area specific to DVD-ROM.

Table 38 – Data Area Allocation Definition

Byte	Single Layer/ Parallel Track Path	Opposite Track Path
4	00h	00h
5	Starting PSN of Data Area (030000h)	Starting PSN of Data Area (030000h)
6		
7		
8	00h	00h
9	End PSN of Data Area	End PSN of Data Area
10		
11		
12	00h	00h
13	000000h	End PSN in Layer 0
14		
15		

The Media Unique Data in the Physical Format area of the Control Data Zone is reserved and zero filled.

4.4.4 DVD-RAM

4.4.4.1 Track Structure

DVD-RAM is a single layer media that may be single sided or two sided. DVD-RAM is available in both 80 mm and 120 mm discs.

4.4.4.2 Sector Structure

The basic DVD ECC block structure as defined in 4.4.2.2 applies to DVD-RAM. For DVD-RAM, the definition of the sector information part of the ID field differs from other DVD media types.

The sector ID field is viewed as a 32-bit field as shown in Figure 33.

Sector Information ID Bits 31 thru 24						
31	30	29	28	27	25	24
Sector Format Type	Tracking Method	Reflectivity	Recording Type	Zone Type	Data Type	Layer Number

Sector Format Type	0b	Indicates CLV format
Tracking Method	1b	Indicates groove tracking
Reflectivity	0b	Indicates reflectivity exceeds 40%
	1b	Indicates reflectivity is less than or equal to 40%
Recording Type	0b	Lead-in, Lead-out, General Data in Data Area
	1b	Real-time Data in Data Area
Zone Type	00b	When sector is in Data Zone
	01b	When sector is in Lead-in Zone
	10b	When sector is in Lead-out Zone
	11b	When sector is in Middle Zone
Data Type	0b	Indicates embossed data
	1b	Indicates rewritable data
Layer Number	0b	DVD-RAM uses only layer 0

Figure 33 – ID Field for DVD-RAM

4.4.4.3 The Lead-in

The DVD-RAM lead-in structure is consistent with the structure shown in Figure 31. Table 39 shows the lead-in structure specific to DVD-RAM.

Table 39 – DVD-RAM Lead-in Structure

Starting PSN	Disc Area
22FA0h	Initial Zone All 00h
2F000h	Reference Code Zone
2F010h	Buffer Zone 1 All 00h
2F200h	Control Data Zone (192 ECC Blocks)
2FE00h	Buffer Zone 2 All 00h
30000h	Defect Controls
31000h	DATA AREA
.	
.	

DVD-RAM is consistent with the general structure of the Control Data ECC Block as shown in Table 33 and the Common Part of the Physical Format Information as shown in Table 34.

Table 40 shows the Data Allocation Area for DVD-RAM.

Table 40 – DVD-RAM Data Area Allocation Definition

Byte	DVD-RAM
4	00h
5	Starting PSN of Data Area (031000h)
6	
7	
8	00h
9	End PSN of Data Area
10	
11	
12	00h
13	000000h
14	
15	

The Media Unique Data in the Physical Format area of the Control Data Zone is shown in Table 41 and Table 42.

Table 41 – DVD-RAM (Ver.1.0) Unique Part of Physical Format Information

Bit	7	6	5	4	3	2	1	0
Byte								
32	Disc Type Identification							
33-47	Reserved							
48	Velocity 1							
49-65	Write conditions at Velocity 1							
66-479	Reserved for write conditions at velocity of Velocity 2 to Velocity 24							
480-2047	Reserved							

Table 42 – DVD-RAM (Ver. 2.1) Unique Part of Physical Format Information

Bit	7	6	5	4	3	2	1	0
Byte								
32	Disc Type Identification							
33-499	Reserved							
500	Velocity							
501-548	Write conditions at Velocity							
549-596	Disc Manufacturer's name							
597-612	Disc Manufacturer's supplementary information							
613-623	Write Power Control Parameters							
624-699	Reserved							
700	3x Speed Velocity (Optional)							
701-757	Write Conditions at 3x Speed Velocity (Optional)							
758-2047	Reserved							

4.4.4.4 DVD-RAM Recording

DVD-RAM is randomly writable in ECC block increments. Random writability in 2 048 byte sectors is accomplished by read-modify-write actions with ECC blocks. DVD-RAM implements defect management that provides for a seamless LBA space for the Initiator.

4.4.5 DVD-R/-RW

4.4.5.1 Track Structure

DVD-R and DVD-RW are single track, single layer media with possible capacities of 3,95 and 4,7 GB.

4.4.5.2 Sector Structure

The basic DVD ECC block structure as defined in 4.4.2.2 applies to DVD-R/-RW. For DVD-R/-RW, the definition of the sector information part of the ID field differs from other DVD media types.

The sector ID field is viewed as a 32-bit field as shown in Figure 34.

Sector Information ID Bits 31 thru 24						
31	30	29	28	27	25	24
Sector Format Type	Tracking Method	Reflectivity	Reserved	Zone Type	Data Type	Layer Number

Sector Format Type	0b	Indicates CLV format
Tracking Method	1b	Indicates groove tracking
Reflectivity	0b	Indicates reflectivity exceeds 40%
	1b	Indicates reflectivity is less than or equal to 40%
Reserved	0b	Reserved
Zone Type	00b	When sector is in Data Zone
	01b	When sector is in Lead-in Zone
	10b	When sector is in Lead-out Zone
	11b	When sector is in Middle Zone
Data Type	0b	Indicates read-only data or rewritable data
	1b	Indicates sector is linking data
Layer Number	0b	When sector is in layer 0
	1b	When sector is in layer 1

Figure 34 – ID Field for DVD-R/-RW

4.4.5.3 The Lead-in

The DVD-R/-RW lead-in structure is consistent with the structure shown in Figure 31. Table 43 and Table 44 show the lead-in structures specific to DVD-R and DVD-RW.

Table 43 – Lead-in Structure: DVD-RW and DVD-R for General Purpose, ver 2.0

Starting PSN	Disc Area
22FA0h	Initial Zone All 00h
2E200h	Buffer Zone 0 (all 00h)
2E400h	Physical Format Information Zone
2F000h	Reference Code Zone
2F020h	Buffer Zone 1 All 00h
2F200h	Control Data Zone (192 ECC Blocks)
2FE00h	Extra Border Zone
30000h	DATA AREA
.	
.	

Table 44 – Lead-in Structure: DVD-R ver 1.0, DVD-R for Authoring ver 2.0

Starting PSN	Disc Area
22FA0h	Initial Zone All 00h
2F000h	Reference Code Zone
2F020h	Buffer Zone 1 All 00h
2F200h	Control Data Zone (192 ECC Blocks)
2FE00h	Buffer Zone 2 all 00h
30000h	DATA AREA
.	
.	

4.4.5.3.1 Control Data Zone

DVD-R/-RW is consistent with the general structure of the Control Data ECC Block as shown in Table 33 and the Common Part of the Physical Format Information as shown in Table 34.

Table 37 shows the Data Allocation Area for DVD-R/-RW.

Table 45 – DVD-R/-RW Data Area Allocation Definition

Byte	DVD-R Ver.1.0 DVD-R for Authoring Ver.2.0 (DAO)	DVD-R Ver.1.0 Incremental	DVD-RW/ DVD-R for General Ver.2.0
4	00h	00h	00h
5 6 7	Starting PSN of Data Area (030000h)	Starting PSN of Data Area (030000h)	Starting PSN of Data Area (030000h)
8	00h	00h	00h
9 10 11	End PSN of Data Area	Last Recorded Sector Number of the last Track in the Session	Last address of Data Recordable area
12	00h	00h	00h
13 14 15	000000h	000000h	000000h

Table 46 – DVD-R Ver 1.0/-R for Authoring Ver.2.0 Unique Part of Physical Format Information

Bit	7	6	5	4	3	2	1	0
Byte								
32~35	Start PSN of the current Border-out							
36~39	Start PSN of the next Border-in							
40-2047	Reserved							

Table 47 – DVD-RW/-R for General Ver.2.0 Unique Part of Physical Format Information

Bit	7	6	5	4	3	2	1	0
Byte								
32~35	Start PSN of the Extra Border Zone (= 02FE10h)							
36~39	Start PSN of Physical format information blocks in Extra Border Zone (= 02FFA0h)							
40-2047	Reserved							

4.4.5.3.2 DVD-R/-RW Physical format information Zone

The R/RW-Physical format information Zone is defined only for DVD-RW and DVD-R for General Ver.2.0 media. The R/RW-Physical format information Zone contains 192 ECC blocks. Each DVD-R/-RW Physical format information consists of 16 sectors and is repeated 192 times.

The structure of R/RW-Physical format information is shown in Table 48.

Table 48 – DVD-R/-RW Physical Format Information Zone

Sector Number	Description
0	Reserved
1	Manufacturing Information
2	Physical Format Information
3	Reserved
:	
15	

The contents of the Physical Format Information in DVD-R/-RW Physical format information Zone is same as the contents of Physical Format Information in Control Data Zone except Data Area Allocation field and unique part of Physical Format Information (byte 32 – byte 2047).

The definition of the Data Area Allocation field in DVD-R/-RW Physical format information is shown in Table 49.

Table 49 – Data Area Allocation Field in DVD-R/-RW Physical Format Information

Byte	Disc at Once	Incremental Write/Restricted Overwrite
4	00h	00h
5	Starting PSN of Data Area (030000h)	Starting PSN of Data Area (030000h)
6		
7		
8	00h	00h
9	End PSN of Data area	Last Recorded Sector Number of the last Track in the Session (1)
10		
11		
12	00h	00h
13	000000h	000000h
14		
15		

NOTE 6: When the Lead-in or Border-in is recorded in the Restricted Overwrite mode, and when the last session is in an Intermediate state, this field shall be set to 30000h.

The definition of the Unique Part of Physical Format Information fields in DVD-R/-RW Physical format information Zone is shown in Table 50. When the Lead-in is recorded in the Disc at once recording mode, this field contains all 00h data.

Table 50 – Unique Part of Physical Format Information in DVD-R/-RW Physical format information

Bit	7	6	5	4	3	2	1	0
Byte								
32 – 35	Start PSN of the current Border-out							
36 – 39	Start PSN of the next Border-in							
40 –2047	Reserved							

4.4.5.3.3 Extra Border Zone

The Extra Border Zone is defined for DVD-RW and DVD-R for General Ver.2.0 media.

The structure of Extra Border Zone is shown in Figure 35.

The structure of Extra Border Zone is similar to Border Zone. However, the length of Extra Border Zone is only 32 ECC blocks and there are no Next Border Markers and Stop Blocks.

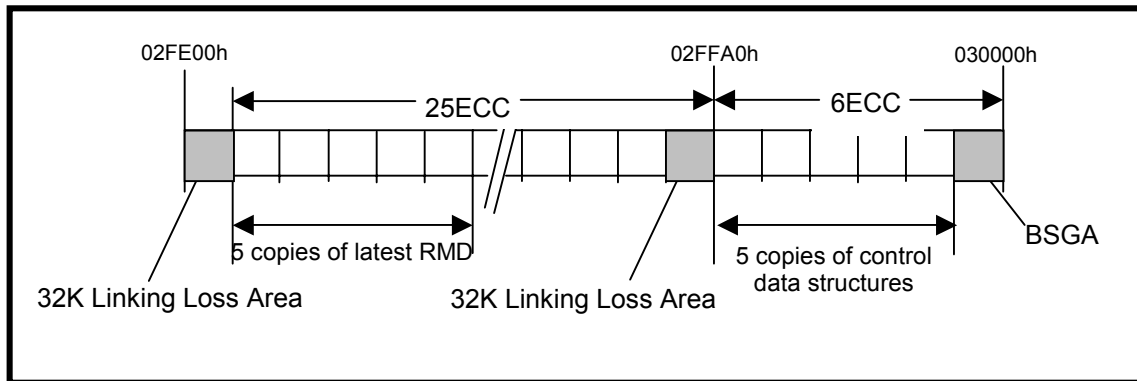

Figure 35 – Structure of Extra Border Zone

4.4.5.4 DVD-R/-RW Recording

4.4.5.4.1 Rzone Description

The DVD-R specification describes a logical entity called Rzone. This standard describes Tracks as they are implemented on CD. An Rzone shall be treated as a Track, with the following differences from a CD Track:

- a) An Rzone may only contain data (no CD Audio Tracks).
- b) An Rzone has a pre-gap of 0 or 16 sectors instead of 150.
- c) An Rzone post-gap size is determined by rounding to the ECC block size, and is 0 – 15 sectors in length.
NOTE 7: Pre-gap, post-gap are not defined in the DVD-R specification. In this standard, pre-gap is Linking Loss Area at the beginning of an Rzone, post-gap is Linking Loss Area at the end of an Rzone. Linking Loss Areas are possible in the middle of an Rzone.
- d) CD track parameters such as Copy, Control, Data Mode, Packet, FP, and Packet Size either do not apply or have constant values. For purposes of reporting, Copy = 0, Control = 5, Data Mode = 1, FP = 0, Packet Size = 16.
- e) The link size is variable due to both user selection of 2k or 32k linking and Logical Unit padding of the last write to an ECC boundary. As in CD, the Next Writable Address may always be obtained via the READ TRACK INFORMATION command.
- f) The maximum number of Rzones is 2 302.
- g) Rzones do not contain sub-channel information.

Whenever this standard references a Track, and the medium is DVD-R, the translation above should be applied.

4.4.5.4.2 Border-in/Border-out

The DVD-R specification describes entities called Lead-in, Lead-out, Border-in and Border-out. DVD-R always has zero or one Lead-in and zero or one Lead-out. The Lead-in, if recorded, is always at the beginning of the disc and the Lead-out, if recorded, is always at the end of the disc. No data may be recorded beyond the Lead-out. The information recording area is a collection of Lead-in/Border-in, Bordered Areas, and Border-out. This area, when written, is called a complete session.

If intermediate interchangeability is desired before recording the Lead-out, a Border-out is written in its place. When additional recording is to be done, a Border-in is recorded between the last Border-out and the new data.

If only a Border-in and Border-out are to be written (after incrementally recording data), the Initiator should set the Multi-session field of the Write Parameters Page to 11b. If set to 11b, and insufficient space exists on the medium for another Border, the Logical Unit shall permanently close the medium by recording a Lead-out. If it is desired to permanently close a disc, the Multi-session field shall be set to 00b or 01b. The Multi-session field is ignored on DVD-R when the Write Type is set to Session at Once, and no next Border is possible. Within this standard Multi-session is used instead of Multi-Border, incomplete session is used instead of incomplete Border, complete session is used instead of complete Border for DVD-R Logical Units.

4.4.5.4.3 RMA Caching

RMA area is the Recording Management Area for DVD-R media. To Update the RMA means to update the RMA on the disc or to update the RMA Cache, that shall be written to the RMA on the disc prior to the removing the disc from the Logical Unit. RMA Caching is vendor specific.

4.4.6 DVD+R

4.4.6.1 Track Structure

DVD+R media is either 8 or 12 centimeters in diameter and separated into zones as shown in Figure 24. The Information zone is organized as a sequence of independently recorded units called ECC blocks. Each ECC block contains 16 user sectors. Each sector is identified by its PSN and contains 2 048 bytes of data.

Physical addresses advance incrementally beginning at the virtual address 00000000h. It is virtual, because the physical nature of a DVD+R device guarantees that no Logical Unit is ever be able to reach the sector with PSN = 0. Similarly, the media is made with a zone of protection in the groove. Consequently, the first sector that is required to exist has a PSN significantly larger than 0. As with DVD-ROM, the first user accessible sector has PSN = 30000h. The DVD+R 120-mm one-sided disc has 4,70GB available to the user, while the two-sided disc has 9,40GB. The DVD+R 80-mm one-sided disc has 1,46GB available to the user, while the two-sided disc has 2,92GB.

4.4.6.1.1 The ADIP (Address in Pre-groove)

Like CD-RW media:

- a) DVD+R media has a wobble structure that defines the groove
- b) Information is modulated onto the wobble
- c) Within the Information Zone, this information contains the address of the associated sector
- d) Within the lead-in, there is additional information about the disc

This is generally called Address-In-Pre-groove or ADIP.

4.4.6.1.2 The ECC Block

The basic DVD ECC block structure as defined in 4.4.2.2 applies to DVD+R. The sector ID field is viewed as a 32-bit field as shown in Figure 29. For DVD+R, the definition of the sector information part of the ID field (Figure 36) differs from other DVD media types.

Sector Information ID Bits 31 thru 24						
31	30	29	28	27	25	24
Sector Format Type	Tracking Method	Reflectivity	Reserved	Zone Type	Data Type	Layer Number

Figure 36 – DVD+R ID Field Details

- Sector Format Type (Bit 31) is set to ZERO, indicating a CLV format
- Tracking Method (Bit 30) is set to ZERO, indicating pit-tracking capability
- Reflectivity (Bit 29) is set to ZERO indicating that the reflectivity exceeds 40 %
- Reserved (Bit 28) and shall be set to ZERO
- Zone Type (Bits 27 and 26) is valued as:
 - 00 when the sector is in the Data Zone
(this includes session lead-in and session lead-out areas)
 - 01 when the sector is in the Disc Lead-in
 - 10 when the sector is in the Disc Lead-out
- Data Type (Bit 25) is set to ZERO, indicating read-only media
- Layer Number (Bit 24) is set to ZERO, indicating that through an entrance surface only one recording layer may be accessed

4.4.6.1.3 DVD+R Groove Layout

The groove, when recorded, is a continuous sequence of ECC blocks. If ECC block E and E+1 are consecutive, then whenever N is the largest PSN in E, then N+1 is the smallest address in E+1. i.e., the ECC blocks are sequenced in an intuitively correct way.

The rest of logical groove architecture is given by specific use of individual sectors.

The DVD+R format provides only a continuous address space with no possibility of defect management. If defect management is desired, it is recommended that the Initiator's system software provide the function.

Table 51 shows the zoned layout of the DVD+R groove. The Data Zone boundaries are based upon a single session recording.

Table 51 – DVD+R Format Lay-out

Disc Area	Zone	120 mm Disc		80 mm Disc	
		Start PSN (h)	Length (d)	Start PSN (h)	Length (d)
INNER DRIVE AREA	Initial Zone	-	Blank	-	Blank
	Inner Disc Test Zone	023080h	16 384	023080h	16 384
	Count Zone Run-in	027080h	1 024	27080h	1 024
	Inner Disc Count Zone	027480h	4 096	027480h	4 096
	Inner Disc Administration Zone	028480h	4 096	028480h	4 096
	Table of Contents Zone	029480h	4 096	029480h	4 096
LEAD-IN	Guard Zone 1	02A480h	14 848	02A480h	14 848
	Reserved Zone 1	02DE80h	4 096	02DE80h	4 096
	Reserved Zone 2	02EE80h	64	02EE80h	64
	Inner Disc Identification Zone	02EEC0h	256	02EEC0h	256
	Reserved Zone 3	02EFC0h	64	02EFC0h	64
	Reference Code Zone	02F000h	32	02F000h	32
	Buffer Zone 1	02F020h	480	02F020h	480
	Control Data Zone	02F200h	3 072	02F200h	3 072
	Buffer Zone 2	02FE00h	512	02FE00h	512
DATA	Data Zone	030000h	2 295 104 (max)	030000h	714 544 (max)
LEAD- OUT	Buffer Zone 3	260540h (max)	768	0DE730h (max)	768
	Outer Disc Identification Zone	260840h (max)	256	0DEA30h (max)	256
	Guard Zone 2	260940h (max)	Min = 4 096	0DEB30h (max)	min = 4 096
OUTER DRIVE AREA	Outer Disc Administration Zone	261940h	4 096	0DFB30h	4 096
	Outer Disc Count Zone	262940h	4 096	0E0B30h	4 096
	Outer Disc Test Zone	263940h	16 384	0E1B30h	16 384
	Guard Zone 3	267940h	Blank	0E5B30h	Blank

4.4.6.2 Recording on DVD+R

4.4.6.2.1 Recording Structures

4.4.6.2.1.1 ECC Blocks

The minimal writable entity on DVD+R is the 32KB ECC block. Physically, DVD+R is randomly writable in 32KB ECC blocks, but not necessarily randomly readable. An ECC block is not fully decodable when it follows a blank area of media. In order to ensure readability, ECC blocks shall be written in sequential regions.

4.4.6.2.1.2 Fragments

A fragment is a set of contiguous ECC blocks in the Data Area that contains at least one ECC block. Fragments are distinct. i.e., given two different fragments, there are no ECC blocks in common. A fragment is the only unit of allocation on DVD+R. A recorded DVD+R disc shall contain at least one fragment.

Fragments are uniquely numbered beginning with one. The start address of fragment one is LBA 0. Fragments are numbered sequentially with no gaps. i.e., if fragment N and fragment M are different fragments and there are no fragments between fragment N and fragment M, then $M = N + 1$.

Fragment Oriented Definitions:

Reserved Fragment – Fragment allocation may be explicit, where both the start address and end address are specified. This is a reserved fragment.

The Incomplete Fragment – Fragment allocation may also be implicit, where the start address of the fragment is specified, but the end address is limited only by disc capacity. This is the incomplete fragment. The incomplete fragment may be transformed into two fragments: a reserved fragment and a new incomplete fragment.

Closed Fragment – If every ECC block within a reserved fragment is written, the fragment is closed.

Next Writable Address – Fragments shall be written sequentially, beginning with the start address of the fragment. This maintains the fragment in two parts: the written part that begins at the fragment start address and the blank part that begins with the first ECC block in the fragment that has not been written. The LBA of the first sector of the blank part is the Next Writable Address (NWA) of the fragment.

The Initiator may write using a 2 048-byte block size. The Logical Unit shall buffer sequentially written data and write only when:

1. An ECC block amount of data has been received from the Initiator,
2. The Initiator issues a SYNCHRONIZE CACHE command,
3. The Initiator issues a CLOSE TRACK command, or
4. A new WRITE command is received for the NWA of a different fragment.

In cases 2 through 4, remaining user data in the ECC block shall be zero filled by the Logical Unit prior to writing the ECC block. If no data is buffered for a partial ECC block, then cases 2 through 4 shall cause no write to occur.

4.4.6.2.1.3 Sessions

The data area of a DVD+R disc may be recorded in sessions similar to session recording in CD-R. Each session contains a lead-in equivalent area called the session "Intro", a data area equivalent called session "user data", and a lead-out equivalent called the session "closure". The Intro of the first session is contained within the disc lead-in and the Closure of the final session is contained within the disc lead-out. Each Intro that is not in the disc lead-in is encoded as data. Each Closure that is not contained within the disc lead-out is encoded as data.

Sessions are uniquely numbered beginning with one. The start address of the user data of session one is LBA 0. Sessions are numbered with sequentially with no gaps. i.e., if session N and session M are different sessions and there are no sessions between session N and session M, then $M = N + 1$.

Figure 37 shows an example of a multi-session layout on a DVD+R disc. Session 2 is called an interior session.

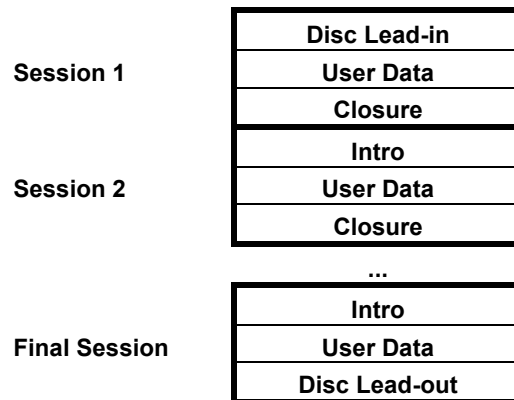

Figure 37 – General Layout of a Multi-Session DVD+R

The user data zone of a session is made up of a collection fragments. The user data zone contains at least one fragment and may contain up to 16 fragments.

Session Oriented Definitions:

Empty (Blank) Session – If no ECC block in a session is written, the session is blank.

Closed Session – If every ECC block within the session is written, the session is closed.

Open Session – If a session is not closed, then the session is open. An empty session is open.

Open (Incomplete, or Appendable) Disc – If a disc has an open session, then the disc is open.

Closed Disc – During the process of closing a session, the Initiator may specify that no new sessions are allowed. That session is called the Final session and once that session is closed, the disc is closed. No new writing is allowed on a closed disc.

Run-in Block – A single ECC block, zero filled and written, shall separate two adjacent fragments within a session. This "run-in block" ensures that the first ECC block of the second fragment of a session is be readable.

The status of a session and of the fragments within its user data zone is found within the session's Intro.

Table 52 shows the zones of a session.

Table 52 – Zones of a Session

Session Zone	Description	Size	
		Physical Sectors	ECC Blocks
Disc Lead-in containing Session 1 Intro	Guard Zone 1	14 848	928
	Reserved Zone 1	4 096	256
	Reserved Zone 2	64	4
	Inner Disc Identification Zone	256	16
	Reserved Zone 3	64	4
	Reference Code Zone	32	2
	Buffer Zone 1	480	30
	Control Data Zone	3 072	192
	Buffer Zone 2	512	32
Session (#1) Intro	Buffer Zone A	64	4
	Inner Session Identification Zone	256	16
	Session Control Data Zone	640	40
	Buffer Zone B	64	4
User Data Zone	User Data	16 min	1 min
Session (not final) Closure	Buffer Zone C	768	48
	Outer Session Identification Zone	256	16
Disc Lead-out containing final session Closure	Buffer Zone 3	768	48
	Outer Disc Identification Zone	256	16
	Guard Zone 2 (minimum size)	4 096	256

The time to write each of these areas is as follows:

- a) When session 1 is opened, Reserved Zone 2 plus an SDCB in the first ECC block of the Inner Disc Identification Zone shall be recorded. When session N ($N \neq 1$) is opened, Buffer Zone A plus an SDCB in the first ECC block of the Inner Session Identification Zone shall be recorded.
- b) The User Data area is written as the Initiator provides data.
- c) When the first ECC block of session 1 is recorded, Buffer Zone 2 shall also be recorded. When the first ECC block of session N ($N \neq 1$) is recorded, Buffer Zone B shall also be recorded.
- d) Whenever fragment N (where N is not the first fragment of the session) is opened, a run-in shall be written prior to writing the first ECC block of fragment N.
- e) The Inner Disc/Session Identification Zone is written incrementally as fragments within the session are defined. When a fragment is defined, a record (the Fragment Item) is included in the Inner Disc/Session Identification Zone that identifies the boundaries of the fragment. When the session is closed, all unused ECC blocks within the Inner Disc/Session Identification Zone are written with all zeros.
- f) The remaining areas are written when the session is closed. The Outer Disc/Session Identification Zone may optionally contain a copy of the Inner Disc/Session Identification Zone. When the final session is closed, the ECC blocks of the lead-out shall be encoded as lead-out.

Session Oriented Rules:

There may be at most one open session on a disc – the session that contains the current incomplete fragment.

When a session is closed a new ECC block is appended to the Table of Contents Zone (see Table 51) containing a TOC item that identifies the bounds of the new session.

A session may be closed only when every fragment within the session is closed.

4.4.6.2.2 The Initiator's Perspective

The MMC command set was developed specifically for CD. Rather than force a new model upon Initiator software developers, the command set described here maintains the CD-R model when working with DVD+R. Certain command set restrictions associated with CD remain with DVD+R.

The Initiator approaches the device and the media from the perspective of CD-R: sectors, packets, tracks, and sessions. For the Initiator, a track is the unit of allocation. The Initiator views a DVD+R fragment as a fixed packet track where the packet size is 16. When a DVD+R session is open, fragments and tracks have equivalent meaning. Numbering for CD-R tracks and DVD+R tracks is different. The READ TOC/PMA/ATIP and READ TRACK INFORMATION commands report information about Logical Tracks. Fragments are not always viewed as Logical Tracks. When the user data zone of a closed session is viewed as a Logical Track, its Logical Track number is the session number. Fragments in the open session are viewed as Logical Tracks with:

$$\begin{aligned} \text{Logical Track Number} &= \text{Session Number} \\ &+ \text{Fragment Number} \\ &- \text{Fragment Number of first fragment in session.} \end{aligned}$$

The Initiator should typically use the following commands for the purpose of inspecting and recording DVD+R media:

READ DISC INFORMATION – Provides detailed information about disc status.

READ TRACK INFORMATION – Provides detailed information about any track. Track number translation is according to the above formula. A reference to track number FFh results in information for the incomplete fragment.

READ TOC/PMA/ATIP (form 0) – Provides general information about tracks on the media. Tracks reported in response to this command represent only closed sessions. Since CD identifies the lead-out as track AAh, the maximum track number is A9h (169d). This provides for a maximum of 153 closed sessions and 16 fragments in the open session. Track number translation is according to the above formula.

READ TOC/PMA/ATIP (form 1) – Provides general information about the last closed session.

WRITE (10 or 12) – Allows writing any sector with location restrictions. The first sector in the write shall begin with the NWA for some track (fragment) in the open session.

SYNCHRONIZE CACHE – When writes to a track (fragment) may not have reached an ECC block boundary, the Initiator may issue this command in order to ensure that all buffered data is actually written to the disc.

RESERVE TRACK – Provides the Initiator with the ability to reserve blank disc space for a single track (fragment). The track is not referenced by a number. The fragment shall be created from the beginning of the incomplete fragment. The new, reserved fragment receives the fragment number of the old incomplete fragment, and a new incomplete fragment shall be given the next fragment number. Up to 15 fragments may be reserved in the open session.

CLOSE TRACK/SESSION (Track) – The Initiator may choose to close a reserved track (fragment) or to define a track (fragment) from the written part of the incomplete fragment.

CLOSE TRACK/SESSION (Session) – For the purpose of making the disc read compatible with a DVD-ROM device, the equivalent of a lead-out (closure) or a real lead-out shall follow user data. The Initiator may request either case with this command.

4.4.6.2.3 Building from a Blank Disc

When a DVD+R disc is blank, the user definable space begins as session 1, fragment 1 at LBA 0. In this state fragment 1 is incomplete. When beginning recording on a blank disc, the Initiator has two options: WRITE beginning at LBA 0 or RESERVE TRACK beginning at LBA 0.

- a) If the Initiator chooses to WRITE, then the Initiator's data is written beginning with LBA 0. The end address of fragment 1 is still unknown, so fragment 1 remains the only fragment on the disc. When this write is processed by the Logical Unit, it shall record a session identification item in the first ECC block of the Inner Disc/Session Identification Zone, leaving 15 blank ECC blocks in that zone. This allows for at most 15 incrementally defined fragments in the session. In this case the session may contain at most 15 fragments. Writing may proceed until the Initiator determines that the fragment is completed. At that point the Initiator may define the fragment as complete by issuing a CLOSE TRACK command. The Logical Unit shall respond by appending an ECC block into the Inner Disc/Session Identification Zone with a new fragment identification item.
- b) If the Initiator chooses to issue the RESERVE TRACK command, then a size shall be selected. The size is rounded up to an ECC block boundary. At this point, the end address of fragment 1 is known, thereby defining fragment 2 as an incomplete fragment beginning at an ECC block after fragment 1. In executing the RESERVE TRACK command the Logical Unit shall record a session identification item and a fragment identification item (for fragment 1) in the Inner Disc/Session Identification Zone, leaving 15 blank ECC blocks in that zone. This allows for at most 16 incrementally defined fragments in the session. In this case the session may contain at most 16 fragments. The reserved fragment may be written sequentially as the Initiator deems it necessary. If all necessary writing

Subsequent fragment usage operates similarly.

When the user wishes to eject the disc, the Initiator should elect to close the currently open session prior to disc eject. This ensures that the disc is read compatible with DVD read-only devices. If the user wishes to disallow further writing after the session is closed, it is possible to select a close function to finalize the disc.

4.4.7 DVD+RW

4.4.7.1 Track Structure

DVD+RW is specified as single layer, either one-sided or two-sided, and available in either 8 centimeter or 12 centimeter.

4.4.7.1.1 The ADIP (Address in Pre-groove)

Like CD-RW media:

- a) DVD+RW media has a wobble structure that defines the groove
- b) Information is modulated onto the wobble
- c) Within the Information Zone, this information contains the address of the associated sector
- d) Within the lead-in, there is additional information about the disc

This is generally called Address-In-Pre-groove or ADIP.

4.4.7.1.2 Logical Structure

The Information zone is organized as a sequence of independently recorded units called ECC blocks. Each ECC block contains 16 user sectors. Each sector is identified by its PSN and contains 2 048 bytes of data.

Physical addresses advance incrementally beginning at the virtual address 00000000h. It is virtual, because the physical nature of a DVD+RW device guarantees that no Logical Unit is ever be able to reach the sector with PSN = 0. Similarly, the media is made with a zone of protection in the groove. Consequently, the first sector that is required to exist has a PSN significantly larger than 0. As with DVD-ROM, the first user accessible sector has PSN = 30000h. The DVD+RW 120-mm one-sided disc has 4,70GB available to the user, while the two-sided disc has 9,40GB. The DVD+RW 80-mm one-sided disc has 1,46GB available to the user, while the two-sided disc has 2,92GB.

4.4.7.2 The ECC Block

The basic DVD ECC block structure as defined in 4.4.2.2 applies to DVD+RW. The sector ID field is viewed as a 32-bit field as shown in Figure 29. For DVD+RW, the definition of the sector information part of the ID field (Figure 38) differs from other DVD media types.

Sector Information ID Bits 31 thru 24						
31	30	29	28	27	25	24
Sector Format Type	Tracking Method	Reflectivity	Reserved	Zone Type	Data Type	Layer Number

Sector Format Type	0b	Indicates CLV format
Tracking Method	1b	Indicates groove tracking
Reflectivity	1b	Indicates reflectivity is less than or equal to 40%
Reserved	0b	
Zone Type	00b	When sector is in Data Zone
	01b	When sector is in Lead-in Zone
	10b	When sector is in Lead-out Zone
Data Type	1b	Indicates rewritable data
Layer Number	0b	DVD+RW uses only layer 0

Figure 38 – ID Field for DVD+RW

4.4.7.2.1 The Groove Layout

The groove, when recorded, is a continuous sequence of ECC blocks. If ECC block E and E+1 are consecutive, then whenever N is the largest PSN in E, then N+1 is the smallest PSN in E+1. i.e., the ECC blocks are sequenced in an intuitively correct way.

The rest of logical groove architecture is given by specific use of individual sectors.

The DVD+RW format provides only a continuous address space with no possibility of defect management. If defect management is desired, it is recommended that the Initiator use the MRW format (see 4.5).

Table 53 shows the zoned layout of the DVD+RW groove.

Table 53 – DVD+RW Media Lay-out

Disc Area	Zone	120 mm Disc		80 mm Disc	
		Start PSN (h)	Length (d)	Start PSN (h)	Length (d)
LEAD-IN	Initial Zone	01D830h	nominal=52 304	01D830h	nominal=52 304
	Inner Disc Test Zone	02A480h	2 048	02A480h	2 048
	Inner Drive Test Zone	02AC80h	12 288	02AC80h	12 288
	Guard Zone 1	02DC80h	512	02DC80h	512
	Reserved Zone 1	02DE80h	4 096	02DE80h	4 096
	Reserved Zone 2	02EE80h	64	02EE80h	64
	Inner Disc Identification Zone	02EEC0h	256	02EEC0h	256
	Reserved Zone 3	02EFC0h	64	02EFC0h	64
	Reference Code Zone	02F000h	32	02F000h	32
	Buffer Zone 1	02F020h	480	02F020h	480
	Control Data Zone	02F200h	3 072	02F200h	3 072
	Buffer Zone 2	02FE00h	512	02FE00h	512
DATA	Data Zone	030000h	2 295 104	030000h	714 544
LEAD-OUT	Buffer Zone 3	260540h	768	0DE730h	768
	Outer Disc Identification Zone	260840h	256	0DEA30h	256
	Guard Zone 2	260940h	4 096	0DEB30h	4 096
	Reserved Zone 4	261940h	4 096	0DFB30h	4 096
	Outer Drive Test Zone	262940h	12 288	0E0B30h	12 228
	Outer Disc Test Zone	265940h	2 048	0E3B30h	2 048
	Guard Zone 3	266140h	nominal=24 400	0E4330h	nominal=7 936

4.4.7.3 DVD+RW Basic Format

Relative to the Initiator, the Data Zone is the user space and should be addressed according to LBA. The physical to logical address mapping for DVD+RW is the same as that for DVD-ROM: When physical sector number (PSN) represents a sector in the data zone, its LBA = PSN – 030000h.

4.4.7.3.1 Reading

When recorded, DVD+RW medium is ECC block readable. An intelligent controller may separate individual sector data from a decoded ECC block. Thus for the Initiator, DVD+RW media is 2 048 byte sector readable.

NOTE 8: The function of locating and separating the data of one specific sector from the appropriate ECC block is typically an automated feature within a silicon sub-system. So, select any 2 sectors within the ECC block. There is virtually no difference in the times required to separate each sector's data from the ECC block. i.e., there is no real performance difference.

4.4.7.3.2 Writing

Since the Initiator's perception is that the media is sector readable, then in order to maintain compatibility with other block devices, a DVD+RW Logical Unit shall be able to also write single sectors for its Initiator.

The Logical Unit is required to write DVD+RW media only in complete ECC blocks. So, the Logical Unit shall often perform a read/modify/write function in order to place the Initiator's data in the correct position within the ECC block. That works when the ECC block to be written has already been written. When the ECC block has never been written and the Logical Unit shall write less than a full ECC block, then the Logical Unit shall create data. The correct method is to zero fill sectors for which no data is available.

4.4.7.3.3 Formatting

When every ECC block in the Information Zone (lead-in, Data Zone, lead-out) of a DVD+RW has been recorded, the disc is "formatted". Clause 21 of *DVD+RW 4,7 Gbytes Basic Format Specifications*, additionally, defines specific data content for all sectors. This makes it DVD+RW formatted.

Neither Read nor Write commands shall be accepted prior to format of blank media. When the media is blank and no format is in progress, the Current bit in both the Random Read and Random Writable features shall be zero.

Physically blank DVD+RW media has no data recorded in its groove, so those devices find no references on the surface of a blank DVD+RW disc. This has been compared to trying to run on ice. There is no control. So, in order to assure read compatibility with DVD-RO devices, it is very important to have formatted media.

The high capacity together with the low (relative to HDD) write speeds means that completely formatting a disc requires more time than desired. This problem is not new with DVD+RW. The solution offered here is recycled from one of many for CD-RW: most of the format time is pushed into background time so that the user never experiences any significant delays. This is done by understanding the use models and arranging for both the Logical Unit and the Initiator to control those use models in order to make an incompletely formatted media appear to be completely formatted.

Background formatting has some controlling requirements:

- a) After some minimal amount of formatting has been performed, the operation goes from foreground time to background time. The formatting operation in the Logical Unit shall strive to maintain the Data Zone in two areas: the inner area written and the outer area unwritten. For data applications devices, the formatting bit map in the FDCB shall be implemented in order to minimize excessive reformatting associated with random writing.
- b) The Initiator should modify its allocation algorithms to minimize blank area fragmentation.
- c) If the user wishes to remove the medium prior to format completion, the Initiator may request that the Logical Unit create a temporary and minimally acceptable lead-out that allows a continuation of the formatting process at a later time. The Initiator may also request that the medium be ejected in its current state.
- d) In support of the previous requirement, the Logical Unit shall provide a format re-start mechanism.
- e) The Logical Unit shall always make current format status available to the Initiator.

Details of how background formatting operates relative to the Initiator are to be found in the description of the FORMAT UNIT command (6.5.4.3).

4.4.8 Disc Control Blocks

DVD+R and DVD+RW media format includes a generalized structure called the Disc Control Block (DCB).

All DCBs include handling control for DVD+RW devices that have no understanding of the specific DCB: the Unknown Content Descriptor (UCD). This bit significant value in the DCB defines actions that the Initiator may take (e.g. write the DCB, do not write the DCB, read the DCB, etc). In the event that the Initiator violates the instructions of the UCD, the associated command shall be terminated with CHECK CONDITION status and SK/ASC/ASCQ values shall be set to ILLEGAL REQUEST/ILLEGAL FUNCTION.

4.5 The MRW Format for ReWritable Media

4.5.1 Overview

The Mount Rainier Format for ReWritable media (MRW) provides an approach to defect management on MM rewritable media that maintains read-only backward compatibility for devices that do not understand MRW while providing a measure of overwrite protection from those same devices.

A MRW format may not be defined for all media, however the specific requirements are minimal:

- a) The media shall consist of a continuously recordable zone that is divided into a lead-in area, followed by a user data area, followed by a lead-out area. See Figure 39.
- b) The medium shall be randomly rewritable.
- c) From the Initiator’s perspective, the recordable block size and readable block size shall be equal and fixed at 2 048 bytes. If the low-level writable block size is greater than 2 048 bytes, then that block size shall be an integral multiple of 2 048 and an integral divisor of 65 536.
- d) The basic medium format shall allow blocks to be written in the lead-in without interfering with the basic medium format.
- e) The media shall have a firm, traditional definition for the physical location of LBA 0.

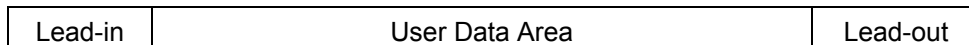

Figure 39 – General Structure of MRW Candidate Media

Each area is redefined by the MRW format as shown in Figure 40:

- a) A Main Table Area (MTA) is reserved from the lead-in. The MTA contains structures that identify the media format and structures for management of the defect replacement system. Parts LI1 and LI2 are not used by the MRW format and either or both may be zero in length.
- b) The General Application Area (GAA) provides minimally 2 Megabytes (2 097 152 bytes) of user space and shall align its logical address space exactly with the logical address space associated with the traditional media format.
- c) The Defect Managed Area (DMA) contains both primary user data zones and spare sector zones. The layout is media specific. The DMA is independently addressable, so it contains its own well-defined LBA 0. The actual spared block size shall be an integral multiple of 2 048, but not larger than the low-level writable block size.
- d) Following the DMA is the Secondary Table Area (STA). The STA is a backup copy of the MTA. The STA provides a way for an Initiator to access the MRW structures when connected to a device that is not MRW capable.
- e) The MRW format may affect the traditional start location of the disc lead-out (LO), but MRW stores no structural information in the disc LO.

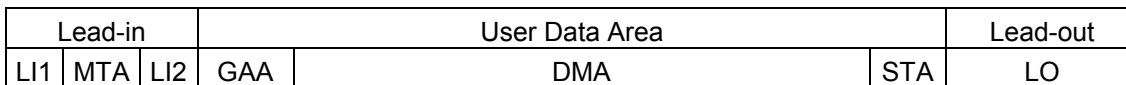

Figure 40 – Main Areas Defined by MRW

4.5.2 Consequences of a Multi-Volume Format

The Mount Rainier format is multi-volume. This simply means that a single, physical medium represents more than a single logical volume. In the case of Mount Rainier, the number of volumes is 2: the GAA and the DMA.

4.5.2.1 LBA Spaces

Two distinct LBA spaces – one for each logical volume – shall be provided. Under normal Initiator accesses, action on one volume is unable to modify data on the other volume. The MRW Logical Unit provides a simple method to select between address spaces: the MRW Mode Page.

When a command references the media by LBA, the result is dependent upon the currently selected

LBA Space.

4.5.2.2 Features and Events

The feature sets associated with GAA and DMA are different. In particular, the DMA has the Defect Management Feature, while the GAA does not.

When a MRW formatted (or formatting) disc is mounted, the Logical Unit shall always default to the LBA Space of the DMA. If the Initiator chooses to select the GAA, then the Logical Unit shall generate a Morph Event and change the set of features that are marked current.

4.5.3 Initiator Requests/Logical Unit Responses

4.5.3.1 General

When the DMA is the current LBA Space of a MRW disc, the Removable Medium, Random Read, Random Write, Formattable, and Defect Management Features are current. Since the Core, Morphing, Timeout, and Power Management Features are common to all defined Profiles, the DMA volume has the Removable Disk Profile as current. Consequently, the Initiator may view the DMA volume of the MRW disc as a removable magnetic medium with a 2 048-byte sector size.

4.5.3.2 Streamed Writing

MRW permits streamed writing. This disables the defect management system during the streamed writing, thereby providing a writing method that yields fixed rate data flows principally for video applications. Streamed writing uses only the primary user space. The spare area is not used. The MRW format has no mechanism for tracking areas that are stream written versus areas that are not stream written. The Initiator is required to provide its own mechanism.

4.5.3.3 Formatting

In order to assure that a disc be recognized as a MRW disc, physically blank media or media with a non-MRW format shall be written. In many cases the entire surface shall be written or rewritten. This may require quite a lot of time. For this reason, MRW requires that most of the formatting occur in background. This shall be done in such a way that the media is accessible for reading and writing as soon as possible.

Background formatting has specific definitions for specific media, but the following general rules apply:

- a) Some minimal amount of formatting shall be done in foreground: initialization of the disc lead-in and GAA. Once this has been performed, the operation may go to background time.
- b) The Logical Unit shall support a mechanism for format suspension and restart.
- c) The Logical Unit shall always make current format status available to the Initiator.

Details of how background formatting operates relative to the Initiator are to be found in the description of the FORMAT UNIT Command.

4.5.3.4 Media Specific Implementations

See Annex J for detailed descriptions of MRW implementations on specific media types.

4.6 Logical Unit Assisted Software Defect Management

4.6.1 General

There are two types of defect management. The one is Initiator-based defect management (software defect management) and the other is logical unit-based defect management (hardware defect management).

In the case of software defect management, an Initiator retrieves defect information from the logical unit and performs defect management at the Initiator's desired timing. e.g., the software defect management is being utilized for CD-RW media. In the case of hardware defect management, the logical unit itself automatically performs defect management like a DVD-RAM logical unit.

Though the capacity of media is dramatically increased in comparison to CD media, the life of RW media is relatively short. The number of acceptable overwrite cycles on a sector is usually one thousand or several thousand. Therefore some sectors of the data area may be worn-out by repeated writing over the life span of the media.

This section defines the Logical unit assisted software defect management method for any type of rewritable media (e.g., CD-RW, DVD-RW) with logical unit that supports Enhanced Defect Reporting Feature. The goal of this model is to provide a defect management mechanism to increase data reliability and media interchangeability after writing the data on a medium by the Initiator and the logical unit. In addition, this model provides a sophisticated real-time defect management with collaboration between the Initiator and the logical unit.

4.6.2 Basic actions for defect management

The Logical unit assisted software defect management consists of the following basic three actions:

1. Certification – Certify blocks on a medium
2. Detection – Detect the use of defective block
3. Management – Manage data on a defective block or manage data to be written on a defective block. Usually, data on a defective block or data to be written on a defective block is relocated to healthy block.

4.6.3 Software Defect management modes

4.6.3.1 General

The Logical unit assisted software defect management model defines two defect management modes. The one is Persistent defect management (Persistent-DM) mode and the other is Distributed real-time defect management (DRT-DM) mode.

4.6.3.2 Persistent defect management (Persistent-DM) mode

In the Persistent-DM mode, the "Certification" and the "Detection" actions are taken by verify after write operation of an Initiator. Then "Management" action is taken by the Initiator.

An Initiator should verify any written data by enabling Certification and by using one of the following commands.

- a) READ (10)
- b) READ (12) with Streaming bit = 0
- c) VERIFY (10)
- d) WRITE AND VERIFY (10)

The logical unit shall perform media certification when one of the above commands is issued to the logical unit. The certification result is stored in Defective Block Information (DBI) memory of the logical unit. In the case of Simple DBI memory model (see 4.6.4.5.2), the DBI data is cleared and updated by the above commands. In response to READ (12) command with Streaming bit = 1, certification is vendor specific.

By using DBI memory, multiple blocks may be certified by logical unit at one command.

4.6.3.3 Distributed real-time defect management (DRT-DM) mode

In addition to the functionality of the Persistent-DM mode, the DRT-DM mode provides functionality that is suitable for real-time streaming applications.

In recording real-time streaming data, recording applications usually suspend or delay the replacement of a defective block to avoid interruption of the real-time recording. In the DRT-DM mode, "Certification" action is taken during a read operation by the Initiator. "Detection" action is taken during a write operation by the Initiator. The Initiator may take "Management" action after the recording operation is complete. Therefore, the DRT-DM mode is able to minimize the performance impact on the real-time operation.

The DRT-DM mode provides for certification before writing. A logical unit performs media certification in response to READ (10), READ (12), or VERIFY (10) command and the logical unit stores the certification result in DBI memory of the logical unit. During writing of a Packet, the logical unit may report a RECOVERED ERROR on WRITE (10) or WRITE (12) command by checking the DBI data that is stored during the certification. To keep compatibility with Persistent-DM mode (verify after write), the logical unit shall certify the block after the writing of the block and then should check the DBI memory in response to READ (10), READ (12), VERIFY (10) or WRITE AND VERIFY (10) command.

DBI data shall be cached in DBI memory. Once a block has been certified at a certain defect level, that block shall not be assigned a lower defect level in DBI memory upon subsequent certification. This ensures that the worst case certification is made available to the Initiator. Regarding the defect level, see 4.6.4.3.

The Initiator may retrieve the stored DBI data at a later time. To keep compatibility with read-only applications that access the disc directly, the Initiator may suspend RECOVERED ERROR reporting on READ (10) or READ (12) command and the Initiator may use RECOVERED ERROR reporting on WRITE (10) or WRITE (12) command instead.

The DRT-DM mode makes use of two types of DBI memory model. One is large DBI buffer model. Another is small DBI cache memory model. See 4.6.4.5, "DBI memory management".

For the DRT-DM mode, logical unit and media shall follow the Defect Level Transition model described in Section 7.6.1. When a fatal error occurs during normal overwriting, a Type 1 or Type 2 defect level shall have been detected by the logical unit before the fatal error happens.

4.6.4 Enhanced Defect Reporting

4.6.4.1 General

Enhanced defect reporting provides media interchangeability by defect management and improves defect management performance by using DBI memory and provides Initiator/application with appropriate logical unit behavior by DBI memory and various defect reporting control.

4.6.4.2 Standard playback model for DVD-RW media

To specify the interchangeable defect level between a write capable logical unit and read-only logical unit, a standard playback model and defect level criteria are defined.

For DVD-RW media, ordinary Consumer Electronics DVD players that support playback of DVD-RW media are defined as standard player for the standard playback model. Error correction order of the standard player is assumed as:

1. PI error correction
2. PO erasure error correction
3. EDC error detection.

No additional error correction is performed by the standard player.

NOTE 9: Standard playback model for other media is not defined.

4.6.4.3 Four types of defect level

The Logical unit assisted software defect management model defines four types of defect level to handle appropriate operation according to each type of defect. The defect level increases from Type 1 to Type 4. Type 4 is the highest severity level.

- a) Type 1: Recovered light defect level
The conceptual criterion is that after 50 ~ 100 overwrite cycles, the Packet may cause uncorrectable error on standard playback model and the number of retry seek operations is small. For DVD-RW media, the recommended error threshold is that the number of PI uncorrectable line is 8 through 15. The number of seek retry times should be smaller than the number of seek retry times for Type 2 defect level. A Packet at or below this defect level should be good for data recording/playback with Consumer Electronics products.
- b) Type 2: Recovered heavy defect level
The conceptual criterion is that several seek retries are required to read the Packet correctly and reading of the Packet may become a fatal error on standard playback model. And after 50 ~ 100 overwrite cycles, reading of the Packet may become a fatal error even with the best error correction of the logical unit. For DVD-RW media, the recommended error threshold is that the number of PI uncorrectable line is 16 or higher. To read a Packet correctly many seek retry operations may be required. A Packet that has this defect level may not be good for data recording/playback with Consumer Electronics products.
- c) Type 3: Unrecovered read error defect level
An unrecovered read error happens or has happened.
- d) Type 4: Write error defect level
Write error has occurred. When RECOVERED ERROR is reported by WRITE (12) command with Streaming bit = 1, some of the specified sectors are not written correctly.

4.6.4.4 Error reporting control

Reporting of a RECOVERED ERROR is controlled by the PER bit in Read/Write Error Recovery Parameters Mode Page (01h). A RECOVERED ERROR only reports the last LBA of one Packet in the REQUEST SENSE data. The Logical unit assisted software defect management that uses DBI memory in the logical unit provides multiple Packet defect reporting capability to increase system performance.

A logical unit shall report a RECOVERED ERROR when

- a) A Type 1 or Type 2 defect is detected on the medium, and
- b) Enhanced Defect Reporting Feature is current, and
- c) RECOVERED ERROR reporting is enabled.

The Enhanced defect reporting capable logical unit uses only one error code for RECOVERED ERROR although there are various other ASC/ASCQs defined for RECOVERED ERRORS. When a Type 1 or Type 2 defect level is detected during media certification, the command shall be terminated with CHECK CONDITION status and sense bytes SK/ASC/ASCQ shall be set to RECOVERED ERROR/RECOVERED DATA – RECOMMEND REASSIGNMENT. When some write operations are failed during streaming write operation by WRITE (12) command with Streaming bit = 1, the logical unit shall terminate the command with CHECK CONDITION status and set sense bytes SK/ASC/ASCQ to RECOVERED ERROR/RECOVERED DATA – RECOMMEND REASSIGNMENT and shall store Type 4 defect level in the DBI memory.

In the case of DRT-DM mode,

- a) If a Type 1, Type 2, or Type 3 defect is found in DBI memory upon receiving a WRITE (10), WRITE (12), or WRITE AND VERIFY (10) command and if no write error happens, the command shall be terminated with CHECK CONDITION status and sense bytes SK/ASC/ASCQ shall be set to RECOVERED ERROR/RECOVERED DATA – RECOMMEND REASSIGNMENT. The data sent by WRITE (10) or WRITE (12) command shall be written to the medium.
- b) If a Type 1, Type 2, or Type 3 defect is found in DBI memory upon receiving a WRITE (10), WRITE (12), or WRITE AND VERIFY (10) command and if write error happens, a deferred write error shall be reported. In this case RECOVERED ERROR is not returned to the Initiator.
- c) If a Type 1, Type 2, or Type 3 defect is found in DBI memory upon receiving a VERIFY (10) command, the command shall be terminated with CHECK CONDITION status and sense bytes SK/ASC/ASCQ shall be set to RECOVERED ERROR/RECOVERED DATA – RECOMMEND REASSIGNMENT.

Error codes to be reported and DBI update states in each case are defined in tables from Table 51 to Table 56.

Table 54 – Returned error code for commands under the Persistent-DM mode

Returned error code ¹					
READ			VERIFY / WRITE AND VERIFY		
no error ²	Type 1 or 2	fatal error ³	no error	Type 1 or 2	fatal error
Good	RECOVERED ERROR/ RECOVERED DATA – RECOMMEND REASSIGNMENT	fatal	Good	RECOVERED ERROR/ RECOVERED DATA – RECOMMEND REASSIGNMENT	fatal

¹The case when RECOVERED ERROR reporting is allowed on the command. Returned error code is not affected by DBI data in DBI memory.
²This means that the defect level is lower than Type 1 defect level.
³If a fatal error happens on this command, does not include a deferred error for previous command.

Table 55 – Returned error code for READ and VERIFY commands under the DRT-DM mode

Returned error code ¹						
Defect Status in DBI memory	READ			VERIFY		
	no error ²	Type 1 or 2	fatal error ³	no error	Type 1 or 2	fatal error
no defect	Good	RECOVERED ERROR/ RECOVERED DATA – RECOMMEND REASSIGNMENT	fatal	Good	RECOVERED ERROR/ RECOVERED DATA – RECOMMEND REASSIGNMENT	fatal
Type 1 or 2	Good		fatal	Good		fatal
Type 3	Good		fatal	Good		fatal
Type 4	Good		fatal	Good		fatal

¹The case when RECOVERED ERROR reporting is allowed on the command.
²This means that the defect level is lower than Type 1 defect level.
³If a fatal error happens on this command, does not include a deferred error for previous command.

Table 56 – Returned error code for commands under the DRT-DM mode

Returned error code ¹						
Defect Status in DBI memory	WRITE			WRITE AND VERIFY		
	no error ²	fatal error ³	fatal error on Streaming bit = 1 ⁴	no error	Type 1 or 2	fatal error
no defect	Good	fatal	RECOVERED ERROR/ RECOVERED DATA – RECOMMEND REASSIGNMENT	Good	RECOVERED ERROR/ RECOVERED DATA – RECOMMEND REASSIGNMENT	fatal
Type 1 or 2	RECOVERED ERROR/ RECOVERED DATA – RECOMMEND REASSIGNMENT	fatal		RECOVERED ERROR/ RECOVERED DATA – RECOMMEND REASSIGNMENT		fatal
Type 3	RECOVERED ERROR/ RECOVERED DATA – RECOMMEND REASSIGNMENT	fatal		RECOVERED ERROR/ RECOVERED DATA – RECOMMEND REASSIGNMENT		fatal
Type 4	RECOVERED ERROR/ RECOVERED DATA – RECOMMEND REASSIGNMENT	fatal		RECOVERED ERROR/ RECOVERED DATA – RECOMMEND REASSIGNMENT		fatal

¹The case when RECOVERED ERROR reporting is allowed on the command.
²This means that the defect level is lower than Type 1 defect level.
³If a fatal error happens on this command, does not include a deferred error for previous command.
⁴This is the case when Streaming bit is set to one, and a block is not correctly written. This block is treated as Type 4 defect.

Table 57 – Returned Deferred error code

Returned deferred error code for previous Write command		
Defect Status in DBI memory	Write command Streaming bit = 0	Write command Streaming bit = 1
no defect	fatal (not specified)	RECOVERED ERROR/RECOVERED DATA – RECOMMEND REASSIGNMENT
Type ½	fatal (not specified)	
Type 3	fatal (not specified)	
Type 4	fatal (not specified)	

Table 58 – DBI update for READ and VERIFY command¹

Update state of DBI data								
Defect Status in DBI memory	READ				VERIFY			
	no error	Type 1	Type 2	Type 3	no error	Type 1	Type 2	Type 3
no defect	no defect	Type 1	Type 2	Type 3	no defect	Type 1	Type 2	Type 3
Type 1	Type 1	Type 1	Type 2	Type 3	Type 1	Type 1	Type 2	Type 3
Type 2	Type 2	Type 2	Type 2	Type 3	Type 2	Type 2	Type 2	Type 3
Type 3	Type 3	Type 3	Type 3	Type 3	Type 3	Type 3	Type 3	Type 3
Type 4	Type 4	Type 4	Type 4	Type 4	Type 4	Type 4	Type 4	Type 4

NOTE 1: This is only applicable for small DBI cache memory model and large DBI buffer memory model.

Table 59 – DBI update for WRITE and WRITE AND VERIFY command¹

Update state of DBI data							
Defect Status in DBI memory	WRITE		WRITE AND VERIFY				
	no error	Type 4	no error	Type 1	Type 2	Type 3	Type 4
no defect	no defect	Type 4	no defect	Type 1	Type 2	Type 3	Type 4
Type 1	Type 1	Type 4	Type 1	Type 1	Type 2	Type 3	Type 4
Type 2	Type 2	Type 4	Type 2	Type 2	Type 2	Type 3	Type 4
Type 3	Type 3	Type 4	Type 3	Type 3	Type 3	Type 3	Type 4
Type 4	Type 4	Type 4	Type 4	Type 4	Type 4	Type 4	Type 4

NOTE 1: This is only applicable for small DBI cache memory model and large DBI buffer memory model

If the logical unit finds defective blocks during the verify operation of VERIFY (10) or WRITE AND VERIFY (10) command, the command shall be terminated with CHECK CONDITION status when all blocks specified by the command are certified or when DBI memory overflow occurs. If DBI memory overflow occurs, the DBI Full (DBIF) bit of DBI descriptor in GET PERFORMANCE command for the Packet that caused DBI buffer full shall be set to 1.

In the case of DRT-DM mode, fatal errors are registered in the DBI memory during the certification process. When the logical unit receives a WRITE command to be written to the fatal error Packet, the logical unit shall terminate the WRITE command with CHECK CONDITION status and set sense bytes SK/ASC/ASCQ RECOVERED ERROR/RECOVERED DATA – RECOMMEND REASSIGNMENT after completion of data transfer. The transferred data shall be written on the media normally.

When a command is terminated with CHECK CONDITION status and sense bytes SK/ASC/ASCQ is set to RECOVERED ERROR/RECOVERED DATA – RECOMMEND REASSIGNMENT the Initiator should check the DBI data.

To keep compatibility with read-only applications (e.g., DVD-Video playback software), reporting of a RECOVERED ERROR on READ (10) or READ (12) command may be suspended by the EMCDR field setting in Read/Write Error Recovery Parameters Mode Page (01h). DBI memory allows for polling of defective Packet information without using RECOVERED ERROR reporting. The EMCDR field controls media certification and error reporting on particular commands as shown in Table 58 – Definition of PER bit and EMCDR field of Persistent-DM mode and Table 59 – Definition of PER bit and EMCDR field of DRT-DM mode.

When a medium is certified, the rotation speed of the logical unit may need to be adjusted to appropriate certification speed. If the certification speed is slower than the maximum reading speed of the logical unit, the Initiator may disable media certification by setting the PER bit and the EMCDR field to 0 to use highest speed of the logical unit for reading operation.

At Power-on reset and hard reset, if the logical unit does not support saving of Read/Write Error Recovery Parameters Mode Page, the PER bit and the EMCDR field shall be set to zero.

The default values of the PER bit and the EMCDR field are 0.

4.6.4.5 DBI memory management

4.6.4.5.1 General

To avoid or minimize DBI data overflow with a small amount of logical unit's hardware resources, there are different memory models defined to store DBI data in a logical unit. They are simple DBI memory model, large DBI buffer memory model and small DBI cache memory model.

The DBI data may be cleared when the logical unit is reset by Hard reset.

The DBI data shall be cleared when the medium is ejected or logical unit is reset by Power on reset.

The DBI data shall not be cleared even if the PER bit and the EMCDR field are both set to zero.

4.6.4.5.2 Simple DBI memory model

The simple DBI memory model is permitted only for the Persistent-DM mode. All stored data in DBI memory is updated at the beginning of medium certification. To ensure that a simple DBI implementation gives a minimum level of usefulness and efficiency to the Initiator, the DBI memory shall be capable of storing at least 10 DBI entries. This allows for the DBI entries to cover a minimum of 256 + 64 KB of defective data (in the case of DVD media) before overflow occurs. This implies that if this minimum is used, the Initiator should not issue a READ, WRITE, or VERIFY command for more than 256 + 64 KB at a time, otherwise the command may overflow the DBI memory. The value of 10 DBI entries assumes half of Track Buffer size and information of VR playback model. The Number of entries field in Enhanced Defect Reporting Feature Descriptor indicates the number of entries that may be stored in DBI memory.

4.6.4.5.3 Large DBI buffer memory model

Some logical units (e.g., logical unit that supports hardware defect management) have enough memory to cover the whole medium for defect management purpose. In this case, the logical unit's memory may cover DBI data for all Packets on CD/DVD media. For the ideal case, logical unit may store DBI data into a DBI bitmap that may cover entire disc. For the practical case, the logical unit's memory may store 10% of the different Packet start addresses of the entire disc and length of consecutive defective Packets. Usually the spare area size is less than 5% of the entire disc capacity. To cover the spare area, 10% of the entire disc capacity should be enough size for Large DBI buffer memory model.

4.6.4.5.4 Small DBI cache memory model

4.6.4.5.4.1 General

The logical unit may have small memory to store DBI data. To minimize the possibility of DBI data overflow and to allow effective Initiator operation, small DBI cache memory model is defined. The DBI data remains in DBI cache even if the data is read by an Initiator. To ensure that a small DBI implementation gives a minimum level of usefulness and efficiency to the Initiator, the DBI cache shall be capable of storing at least 10 DBI entries.

4.6.4.5.4.2 Three types of memory blocks in DBI memory

In the small DBI cache memory model, the DBI memory is divided into three memory blocks to minimize the possibility of DBI data overflow. Each memory block is referred to as Buffer DBI (BDBI), Read DBI (RDBI) cache, and Write DBI (WDBI) cache, respectively.

1. Buffer DBI (BDBI) block: to store certification information of sectors in data buffer
2. Read DBI (RDBI) cache memory block: to copy data from BDBI by a READ command
3. Write DBI (WDBI) cache memory block: to copy data from RDBI by a WRITE command, copy data from BDBI by a VERIFY command

The certification result of READ (10) or READ (12) command is stored in RDBI cache. The certification result of VERIFY (10) command and WRITE AND VERIFY (10) command is stored in WDBI cache. A logical unit shall check RDBI cache by WRITE (10) or WRITE (12) command. If a defective Packet is found in RDBI cache, the DBI data in RDBI cache is copied to WDBI cache.

In the case of the large DBI buffer memory model, the DBI data is stored into a DBI buffer directly, then these three types of memory blocks are unified into single DBI buffer.

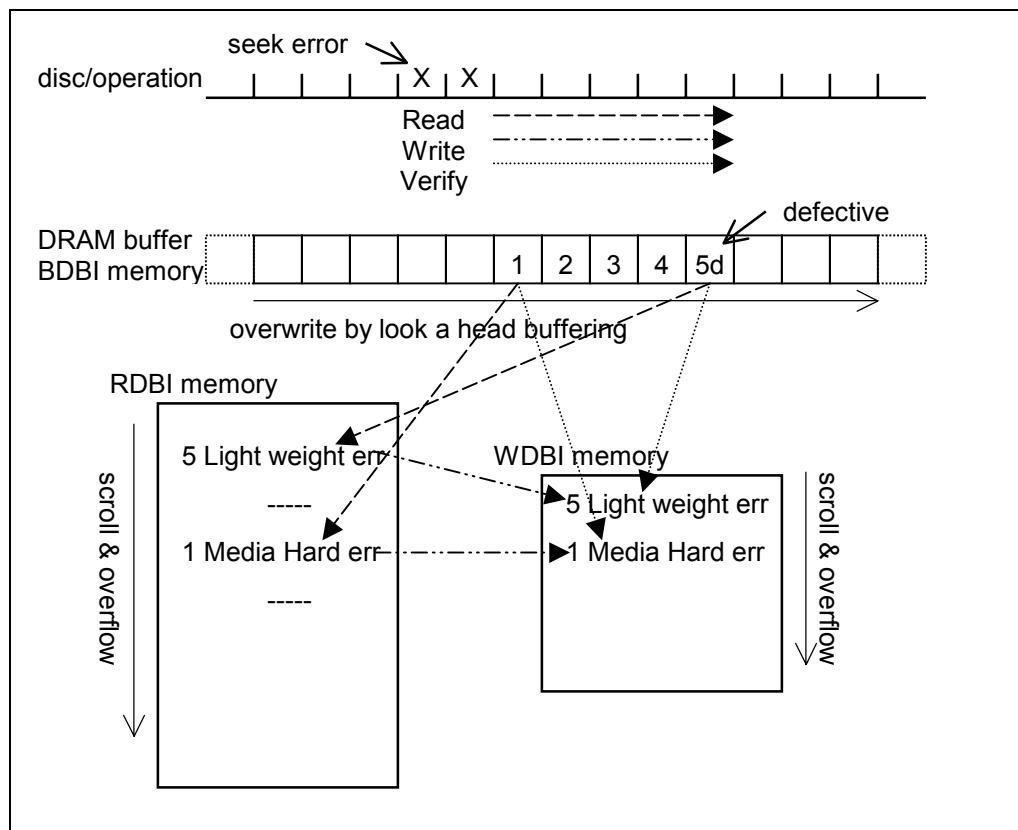

Figure 41 –Example of DBI memory blocks

4.6.4.5.4.3 Adjust DBI cache for a real-time application

The data in RDBI and WDBI cache memories may easily overflow due to accessing of multiple/large files. To protect DBI data against overflow, disc volume space may be divided into a few zones named DBI cache zone. The RDBI and WDBI caches are allocated for each DBI cache zones. e.g., in the case of UDF file system version 2.00 and DVD-VR application, at least two DBI cache zones are required to be supported. Table 60 shows an example of the DBI cache zone image.

In the case of large DBI buffer memory model, the logical unit shall report the Number of DBI cache zones field value of 1 in Enhanced Defect Reporting Feature Descriptor. The logical unit shall report single DBI cache zone that starts from LBA 0 to the end of the medium by GET PERFORMANCE command with Type = 05h.

Table 60 – Example of DBI cache zone image

DBI cache Zone	Major contents	Remark	Sparing
0 ¹	VRS	from 10h	not covered by sparing of UDF very important many overwritten file system data
	AVDP	100h	
	main Volume Descriptor Sequence	by AVDP	
	reserve Volume Descriptor Sequence	by AVDP	
	Logical Volume Integrity Descriptor	by VDS	
	primary Sparing Table	by VDS	
	Spare Area	by VDS	
	secondary Sparing Table	by VDS	
	Beginning of Spareable Partition	by VDS	subject of sparing
	Free Space Bitmap	by VDS	
	root File Entry for root directory	by VDS	
	File Entry for DVD_RTAV	by root File Entry	
	VR_MANAGR.IFO	by VR File Entry	
1 ²	VR_MANAGR.BUP	by VR File Entry	subject of sparing but not suitable to spare
	VR_MOVIE.VRO	by VR File Entry	
	VR_AUDIO.VRO	by VR File Entry	
	VR_STILL.VRO	by VR File Entry	

¹First DBI cache zone: from LBA 0 to before VR object files. There are very important UDF descriptors and information that are not covered by Sparing of UDF. And there are important contents that are able to be replaced to Spare Area.

²Second DBI cache zone: from beginning of VR object files to the end of disc volume space. There are real-time contents that should not be replaced to the Spare Area.

4.6.5 Implicit synchronize cache

When a medium certification is enabled and READ or VERIFY command is issued, and if the data to be read by the command is still remaining in the write cache of the logical unit, the unwritten data shall be committed to a physical medium prior to the certification and then logical unit shall read from the medium and certify the data to perform medium certification correctly.

4.6.6 Persistent-DM mode behavior

4.6.6.1 General

In the Persistent-DM mode, the Initiator should check the defect level of the Packets after write. The logical unit stores the certification result corresponding to each READ (10)/READ (12) command with Streaming bit = 0/VERIFY (10)/ WRITE AND VERIFY (10) command in the DBI memory. One of three DBI memory models is used. As for DBI memory model, see 4.6.4.5, "DBI memory management".

The Initiator should enable media certification by setting of PER bit or EMCDR field.

In Persistent-DM mode, media certification by READ (12) command with Streaming bit =1 is not required. Some logical units may be unable to guarantee real-time streaming playback on 1X CLV speed in PC environment. When READ (12) command with Streaming bit =1 is issued, the rotation speed is usually higher than the speed for certification. Thus, the certification may not be able to be performed. The Type 1 defect level is detected by using READ (10), READ (12) with Streaming bit = 0, or VERIFY (10) command. The Type 1 defect level means the Packet readability is good enough for real-time playback (i.e., READ (12) with Streaming bit = 1 should not have trouble on reading the Packet).

An Initiator should check the defect level of the Packet using READ (12) command with Streaming bit = 0 to keep the disc compatible with standard playback model.

4.6.6.2 RECOVERED ERROR reporting control for Persistent-DM mode

When the PER bit is set to one and/or EMCDR field is set to one or higher, the logical unit perform certification and report RECOVERED ERROR on READ (10)/READ (12) with Streaming bit =0, VERIFY (10), or WRITE AND VERIFY (10) command.

If PER bit is set to zero, the EMCDR field controls the RECOVERED ERROR for defect management as defined in Table 61. In this case, sense bytes SK/ASC/ASCQ shall be set to RECOVERED ERROR/RECOVERED DATA – RECOMMEND REASSIGNMENT.

If the PER bit is set to one, various kinds of RECOVERED ERROR shall be returned for any type of command. And if the EMCDR field is set to zero, the reported RECOVERED ERROR for defect management is vendor specific. If the EMCDR field is set to a value other than zero, sense bytes SK/ASC/ASCQ shall be set to RECOVERED ERROR/RECOVERED DATA – RECOMMEND REASSIGNMENT.

Table 61 – Definition of PER bit and EMCDR field of Persistent-DM mode

PER bit	EMCDR field value	Media certification ¹	RECOVERED ERROR reporting ²		
			READ ³	VERIFY	Other commands
0	0	Disabled	N/A	N/A	No
	1	Enabled	No	No	No
	2	Enabled	No	Yes	No
	3	Enabled	Yes	Yes	No
1	0	Enabled	N/A	N/A	Yes ⁴
	1	Enabled	Yes	Yes	Yes
	2	Enabled	Yes	Yes	Yes
	3	Enabled	Yes	Yes	Yes

¹On READ (10), READ (12) with Streaming = 0, VERIFY (10), or WRITE AND VERIFY (10) command.

²Except for the note 4 case, RECOVERED ERROR/RECOVERED DATA – RECOMMEND REASSIGNMENT is used for defect management purpose.

³On READ (10) or READ (12) command with Streaming=0. READ (12) with Streaming =1 is not included.

⁴Logical unit is allowed to use any RECOVERED ERROR code to keep legacy compatibility.

4.6.6.3 Recommend Initiator sequence of Persistent-DM mode

Recommend Initiator sequence of Persistent-DM mode

At the time of disc mounting

1. Turn on media certification (EMCDR field in Read/Write Error Recovery Parameters Mode Page)
2. Try to recognize file system of the disc
3. If the Initiator's File System driver does not support the file system on the disc, turn off media certification (EMCDR field in Read/Write Error Recovery Parameters Mode Page). Then pass the disc to the next possible file system driver.

At the time of disc writing

1. Write several Packets
2. Verify the written Packets
3. If a RECOVERED ERROR is reported, retrieve DBI information.

At the time of disc unmounting

1. Synchronize all cached data to the disc
2. Turn off media certification (EMCDR field in Read/Write Error Recovery Parameters Mode Page)
3. Un-mount the disc

4.6.7 DRT-DM mode behavior

4.6.7.1 General

The basic three actions of defect management are performed by different commands and timing. Certification and Detection are separated in READ command and WRITE command respectively, and are connected by DBI memory. Either small DBI cache model or large DBI buffer model shall be used.

The EMCDR field controls the reporting of RECOVERED ERRORS. The Initiator is able to receive RECOVERED ERROR by use of certain commands (e.g., media access command). The Initiator is able to retrieve DBI data at a time convenient to the Initiator.

1. Certification is performed at READ (10), READ (12) or VERIFY (10) command. The result is stored in DBI memory.
2. Detection is performed at WRITE (10) or WRITE (12) command with checking of DBI memory. The result is reported as RECOVERED ERROR of WRITE (10) or WRITE (12) command.
3. Management is performed by the Initiator. If the Initiator receives a RECOVERED ERROR at completion of a WRITE command, the Initiator should perform necessary management of written data. The Initiator is able to retrieve the DBI data from DBI buffer at any time.

There are two types of memory model for DBI memory. One is the large DBI buffer memory model that covers all Packets on the media. This memory model never cause DBI buffer overflow. Another is the small DBI cache memory model. This model has a special scheme to minimize cache overflow. But cache overflow is possible.

The EMCDR field controls DRT-DM behavior. When a logical unit reads medium and the EMCDR field is set to a value other than 0, the logical unit shall certify Packets on the medium and store the certification result into DBI memory regardless of Streaming bit setting of READ (12) command. In the case of DRT-DM mode, media certification by READ (12) command with Streaming bit = 1 shall be supported.

In the DRT-DM mode, when a write error happens at WRITE (12) command with Streaming bit = 1, the result shall be stored in DBI memory. Error reporting is dependent on the PER bit and the EMCDR field setting. If RECOVERED ERROR reporting is disabled, no RECOVERED ERROR shall be reported. In this case, the Initiator should check DBI data after the writing operation of WRITE (12) command with Streaming =1, if necessary.

4.6.7.2 Defect Level Transition model

In the case of real-time stream recording, the Initiator and logical unit are not able to perform verify

after write operation and defect management. Because data allocation of the real-time stream (e.g., real-time Video data) shall be determined before writing on the medium to keep data format compatibility and playback compatibility. The real-time stream data flows from Initiator to logical unit continuously. Usually there is no time for verify after write operation and defect management. To guarantee the readability of written Packet, the Initiator needs to verify the Packet before write.

In the DRT-DM mode, the logical unit and media shall support Defect Level Transition model. If there is neither physical impact to media (e.g., scratch, finger print) nor physical impact to logical unit (e.g., shock, vibration), error level of a Packet shall not change from non-defect level to fatal defect level. Type 1 defect or Type 2 defect shall be reported before the Packet becomes unreadable by ordinary direct overwrite cycles.

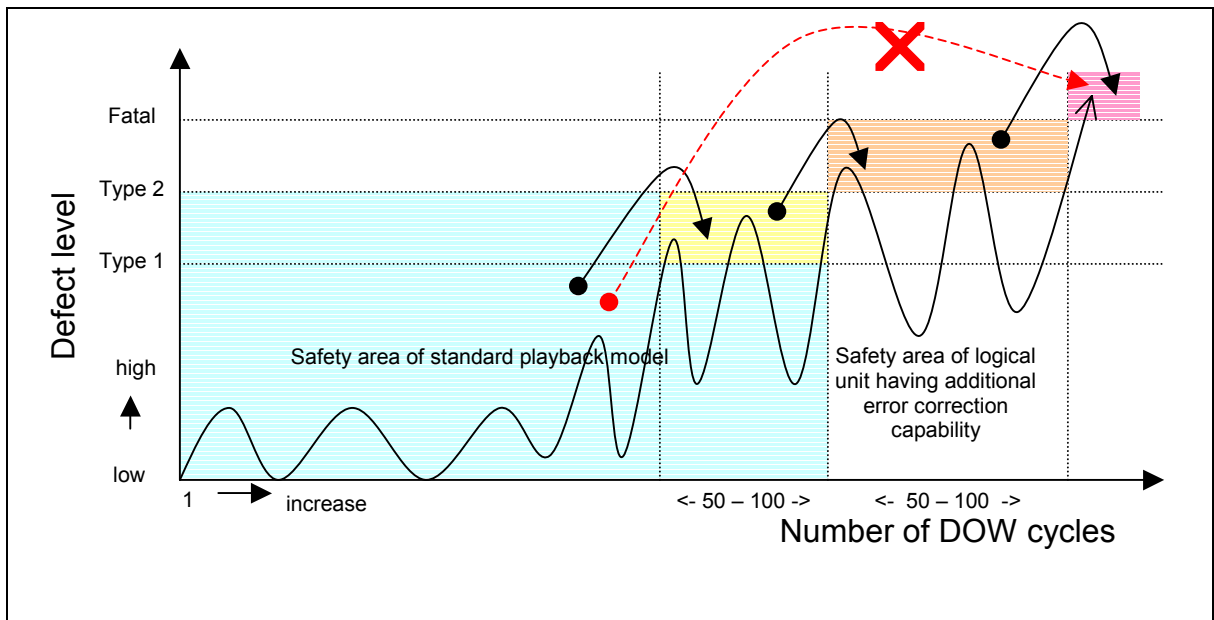

Figure 42 –Example of defect level transition

4.6.7.3 Certification

At READ command, the logical unit shall certify specified blocks to be read. The result is stored in DBI memory.

In the case of small DBI cache memory model, the information of actually transferred blocks shall be stored in RDBI cache. The information of the blocks those are out of range of the command (e.g., read by look ahead buffering but not transferred to Initiator) shall not be stored in the RDBI cache because the blocks may already be replaced and no longer be used by the Initiator.

If the logical unit finds defective blocks in VERIFY (10) or WRITE AND VERIFY (10) command, the command shall be terminated with CHECK CONDITION status when all blocks specified by command are certified or when DBI cache overflow occurs. The logical unit shall report RECOVERED ERROR to the Initiator. The result is stored in DBI memory.

READ (10), READ (12), and VERIFY (10) command shall be performed normally regardless of certification. If a fatal error is detected, the logical unit shall report the error normally.

4.6.7.4 Detecting the use of a defective block

Detection is performed by WRITE (10) or WRITE (12) command. The logical unit shall check all written block addresses by RDBI cache or DBI buffer. When a defect information is found, the logical unit shall terminate the WRITE command with CHECK CONDITION status after all data is transferred. The logical unit shall report a RECOVERED ERROR to the Initiator. All buffered data shall be written on the media properly even if WRITE command is terminated with CHECK CONDITION status. In the case of small DBI cache memory model, when defective block is used by a

WRITE command, the logical unit shall store the information in WDBI cache.

If a fatal error is detected, the logical unit shall report the error normally.

4.6.7.5 Management of defective block

When the Initiator pauses current real-time operation, the Initiator should perform defect management of used defective blocks, if necessary. Some of the information on defective blocks may have important data to be replaced. Some other may not be needed to replace. In the case of real-time streaming data (e.g., video stream), the data blocks are not allowed to be replaced. The Initiator should select suitable defect management method for such data.

If the Initiator receives a RECOVERED ERROR at WRITE command, some of information had been written on defective blocks. The Initiator should read the DBI data by GET PERFORMANCE command with Type = 04h. The Initiator should determine the data on defective blocks that shall be managed.

4.6.7.6 Delayed replacement of data on defective block

The RECOVERED ERROR reported by a logical unit means that some of the used sectors by WRITE command are not reliable. After hundred (it may be a few hundred initially, a few times finally) overwrite cycles on the same block, the block may become unreadable. Therefore, the Initiator may read the written data from defective blocks, and may write them into spare area.

4.6.7.7 RECOVERED ERROR reporting control for DRT-DM mode

When the PER bit is set to one and/or the EMCDR field is set to one or higher, the logical unit shall perform media certification and shall report RECOVERED ERROR on READ (10), READ (12), VERIFY (10), or WRITE AND VERIFY (10) command regardless of Streaming bit setting.

If the EMCDR field is set to zero, the logical unit should not store the certification result in DBI memory to avoid overflow when the logical unit supports small DBI cache memory model.

If the PER bit is set to zero, the EMCDR field controls the RECOVERED ERROR for defect management as defined in Table 59. In this case, sense bytes SK/ASC/ASCQ shall be set to RECOVERED ERROR/RECOVERED DATA – RECOMMEND REASSIGNMENT. See 4.6.4, “Enhanced defect reporting”.

When WRITE (10) or WRITE (12) command is terminated with a RECOVERED ERROR, the logical unit shall write the data to the medium.

The error code of the write failure on WRITE (10), WRITE (12), or WRITE AND VERIFY (10) command is not defined in this model section. See each media model section and WRITE (10), WRITE (12), or WRITE AND VERIFY (10) command sections.

The error code of the read failure on READ (10) or READ (12) command is not defined in this model section. See each media model section and READ (10) or READ (12) command sections.

If the PER bit is set to one, various kinds of a RECOVERED ERROR shall be returned for any type of command. If the EMCDR field is set to zero, the reported RECOVERED ERROR for defect management is vendor specific. If the EMCDR field is set to a value other than zero, sense bytes SK/ASC/ASCQ shall be set to RECOVERED ERROR/RECOVERED DATA – RECOMMEND REASSIGNMENT.

Table 62 – Definition of PER bit and EMCDR field of DRT-DM mode

PER bit	EMCDR field value	Media certification ¹	RECOVERED ERROR reporting ²			
			READ ³	VERIFY	WRITE	Other commands
0	0	Disabled	N/A	N/A	N/A	No
	1	Enabled	No	No	No	No
	2	Enabled	No	Yes	Yes	No
	3	Enabled	Yes	Yes	Yes	No
1	0	Enabled	N/A	N/A	N/A	Yes ⁴
	1	Enabled	Yes	Yes	No	Yes
	2	Enabled	Yes	Yes	Yes	Yes
	3	Enabled	Yes	Yes	Yes	Yes

¹On READ (10), READ (12), VERIFY (10), or WRITE AND VERIFY (10) command.

²Except for the note 4 case, RECOVERED ERROR/RECOVERED DATA – RECOMMEND REASSIGNMENT shall be used for defect management.

³On READ (10) or READ (12) command.

⁴Logical unit is allowed to use any RECOVERED ERROR code to keep legacy compatibility.

4.7 Real-Time Stream Recording/Playback Model

4.7.1 General

Some applications (e.g. real-time audio and video recording/playback) require a minimally consistent data rate. Although the desired data rates are typically, significantly below the media surface rates, delays due to recovery operations and accessing fragmented data may slow the average data rate such that it falls below the application's minimum requirement. A large semiconductor buffer may provide some advantage through data rate averaging, however delays are only redistributed and a buffer of sufficient size for all cases may be impractical. The Real-time Stream Recording/Playback model defines several mechanisms that address the specific problems independently.

4.7.2 Real-Time Stream Playback

The presence of the Real-time Streaming Feature specifies that the MM reader has implemented functions that aid in real-time stream reading.

The MM reader shall implement:

- a) The GET PERFORMANCE command in order to notify the Initiator's application of sustainable read data rates.
- b) The SET STREAMING command in order to receive the application's data rate requirements.
- c) The SET READ-AHEAD command in order that the application may navigate the MM reader's read-ahead process.
- d) The READ (12) command in order that the application may specify that data rate is more important than data quality.

Real-time Stream Playback model addresses various causes of delay in streamed playback:

Controlling Stream Interruptions

When the media surface data rate is significantly higher than the data rate demanded by the application, the MM reader may use its read-ahead buffer as a mechanism to cover a stream interruption. If the reader has options for controlling the duration of a data stream interruption, knowledge of the required data rate may provide the application with seamless data delivery.

The application may notify the MM reader of the minimum data rate requirements by specifying them in the SET STREAMING command. The MM reader may limit certain operations (typically recovery) in order to maintain the minimum requirement.

Fragmented Storage

Even with no error recovery loss in the data, the MM device may be unable to use a read-ahead mechanism to cover data rate loss due to physical fragmentation of the logical flow due to data set navigation requirements.

The SET READ-AHEAD command provides a real-time method by which the application may schedule a redirection of the read-ahead function. This maximizes buffer utilization in data rate averaging over the loss due to seeking.

Read Retries

Many physical properties of the reader system may yield uncorrected data upon the initial read attempt, but corrected data after some number of read retries. The cost of each read retry is a full media rotation.

Each read retry is performed at a cost of one full revolution of the disc. If the application is tolerant of small error bursts, it may use the READ (12) command with the stream bit set to 1.

The MM reader may return sector data that has not been completely corrected. The MM reader may still choose to perform retries if it is determined that it is possible to maintain data rate specified by the SET STREAMING command.

Accessing Defect Replacements

This is similar to the fragmented storage case. The hardware defect management system built into the media format redirects the MM reader to defect replacements. This typically causes 2

seek losses for access to only a small amount of data.

If the application is tolerant of large error bursts, it may use the READ (12) command with the stream bit set to 1. The MM reader may disable its hardware defect management system and deliver fabricated data. The MM reader may still choose to insert defect replacements into the data stream if it is determined that the SET STREAMING specified data rate may be maintained.

Sector not found, loss of tracking errors

Some serious errors may result in several contiguous, unrecoverable sectors.

If the application is tolerant of large bursts of missing data, it may use the READ (12) command with the stream bit set to 1. The MM reader may disable its hardware defect management system (if any) and deliver fabricated data (typically all zeros). The MM reader may still choose to insert defect replacements into the data stream if it is determined that the SET STREAMING specified data rate may be maintained.

Catastrophic Delays

The application may not have specified a required minimum data rate in the SET STREAMING command. Error recoveries are not time limited. This may lead to undesired and lengthy interruptions of read data.

The MM reader may optionally implement Group 3 timeouts in order to place a time limit on error recoveries.

4.7.3 Error Handling with Hardware or No Defect Management

An erroneous block encountered on Stream playback operation should be handled according to Table 63.

Table 63 – Stream Playback Operation Error Handling

Sector Status	Command	Description
Good block	Read (10) and Read (12) with Stream=0	No Error
	Read (12) with Stream=1	No Error
Defective block registered in defect list and replaced	Read (10) and Read (12) with Stream=0	No Error
	Read (12) with Stream=1	No Error (Defect list is ignored, Null (00h) data shall be returned for Blocks listed in a defect list) ¹
Defective block registered in defect list, but not replaced or defective block with Recording Type ³ bit set to 1	Read (10) and Read (12) with Stream=0	No Error (NULL (00h) or partially corrected data may be returned) ²
	Read (12) with Stream=1	No Error (Erroneous data may be returned)
Defective block that is not registered in defect list (includes the DVD+R and DVD+RW defective block cases).	Read (10) and Read (12) with Stream=0	Report Error (Erroneous data shall not be returned when TB=0)
	Read (12) with Stream=1	No Error (Erroneous data may be returned)
¹ A legacy Logical Unit that may not comply with this specification may return erroneous data and continue reading.		
² This is defined to allow playback on a legacy system that uses the conventional READ command.		
³ Recording Type is defined only for DVD-RAM.		

Cached data that contains an erroneous portion shall not be returned by the READ (12) command when the Streaming bit cleared. In such cases, cached data in a buffer memory is discarded and attempts to read with the conventional READ operation.

4.7.4 Real-Time Stream Recording

A hardware defect management scheme like a Linear Replacement Algorithm (Figure 43) is applied when the Logical Unit encounters a defective sector during the conventional WRITE operation. This is done to provide a defect free LBA space.

For Stream recording applications, a hardware defect management may insert delays, potentially violating the minimal data rates required by the application.

With Real-Time Stream Recording, the Logical Unit shall not replace a defective block even if the Logical Unit encounters a defective block during the recording operation.

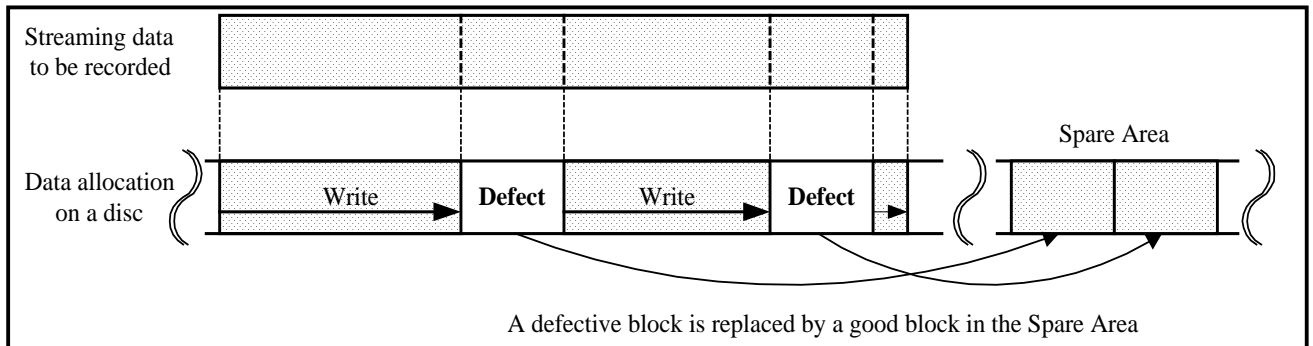

Figure 43 – Example of Data Allocation in case of Linear Replacement

The Logical Unit that returns Real-Time Streaming Feature with Version field of 1 and SW bit of 1 shall supports the following functions.

An example of data allocation on a disc is shown in Figure 44. When the Stream recording operation is performed the Logical Unit shall continue recording without reporting error even if a defective block is found on the Stream recording operation. The Streaming data recorded to the defective block may not be read correctly.

The Initiator should use WRITE (12) command with Streaming bit set to one to perform the Stream recording operation. The Logical Unit shall not perform the Linear Replacement operation for defective block. The Logical Unit’s performance shall be at least 1x speed even if this prevents the Logical Unit from retry or verify operation.

The Logical Unit shall not report CHECK CONDITION status except fatal error, even if a defective block is found on Stream recording operation. The Logical Unit returns a fatal error when the Stream recording operation may not be continued because of critical error such as hardware error.

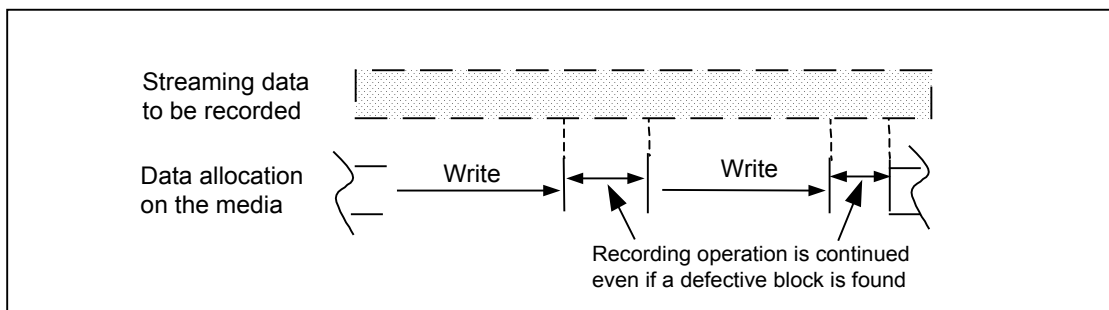

Figure 44 – An example of data allocation on the Stream recording operation

4.7.5 Error Handling with Hardware or No Defect Management

An erroneous block encountered on Stream recording operation should be handled according to Table 64. The defective block may be registered in the defect list but the linear replacement algorithm shall not be applied.

Table 64 – Error Handling on Stream Recording Operation

Sector Status	Command	Description
Good block	Write (10) and Write (12) with Stream=0	No Error
	Write (12) with Stream=1	No Error
Defective block registered in defect list and replaced	Write (10) and Write (12) with Stream=0	No Error
	Write (12) with Stream=1	Ignore defect list and keep recording (The data written on the defective block is not guaranteed)
Defective block registered in defect list, but not replaced or defective block with Recording Type ¹ bit set to 1	Write (10) and Write (12) with Stream=0	No Error (The defective block should be replaced and the data should be written to an alternative block)
	Write (12) with Stream=1	No Error (The data should be written to the defective block without error reporting, and the defective block should still be registered in defect list) ²
Defective block that is not registered in defect list (includes the DVD+R defective block and DVD+RW defective block cases).	Write (10) and Write (12) with Stream=0	No Error (The defective block should be replaced and the data should be written to an alternative block)
	Write (12) with Stream=1	No Error (The data should be written to the defective block without error reporting, and the defective block should be registered in defect list) ²
¹ Recording Type is defined only for DVD-RAM.		
² The defective block should be registered in defect list, but linear replacement shall not be applied.		

4.7.6 Error Handling with Software Defect Management

When Enhanced Defect Reporting Feature (0029h) is current, error reporting shall follow the setting of the PER bit and the EMCDR field in Read/Write Error Recovery Parameters Mode Page (01h). When the logical unit transfers erroneous data to the Initiator or when the logical unit writes data to defective blocks, and if error reporting is enabled by setting of the PER bit and/or the EMCDR field, the logical unit shall complete the READ (12) command with Streaming bit set to one/WRITE (12) command with Streaming bit set to one with CHECK CONDITION status, RECOVERED DATA – RECOMMEND REASSIGNMENT at the command completion.

4.7.7 Fatal error recovery model with Group 3 time-out

Group 3 time-out and commands that are included in Group 3 time-out are used for fatal error recovery at real-time stream recording/playback.

When a fatal error has occurred during real-time stream recording/playback operation, the Initiator needs some recovery action to climb over or fix the fatal error. e.g., in case of playback, application user may want to see further story than the suspended scene. In case of recording, application user may want to use the disc for another recording. If the Initiator did not perform any recovery action, the next recording may encounter the same fatal error again.

To recover from fatal error, there are two points to be taken care.

1. Reasonable response time
2. Defend from more damage

If recovery action takes very long time, in case of playback, application user may not wait such long time. In the worst case, user may be confused as system freezes. In case of recording, Streaming data may be lost. Hence the recovery action should be limited to be terminated within a reasonable time length.

A fatal error of Real-time Stream recording/playback is usually the physical problem of the logical unit

(e.g., to hinder the logical unit from positioning the optical pickup to the target track, focusing the laser beam to the disc surface or finding the target sector). Unnecessary overdoing of retry action may cause more physical damage of the logical unit or the medium. Then Initiator needs to select appropriate method and retry times. The logical unit should not perform too much retry action internally.

4.8 Write Protect

4.8.1 Types of Write Protect

For MM devices, Write Protection is defined only for rewritable media. There are six write protection types:

- a) Cartridge Write Protect
The user may set or release a Write Protection Switch or tab to disable data modification on the media.
- b) Media Specific Write Inhibit
Some Logical Units may disable writing to certain types of DVD-RAM media when the disc is not in a cartridge.
- c) Software Write Protect until Power-down
An Initiator may request write inhibit by the Logical Unit. This write protection is typically lost after a reset or power toggle.
- d) Persistent Write Protect
The Logical Unit may establish write inhibit by writing into a non-user area of the disc.
- e) Write Inhibit DCB
The Initiator may select from several write protect options. Although similar to PWP, there are more write protect options.
- f) Initiator Managed Protection
This is typically File System level protection. Initiator Managed Protection is beyond the scope of this document.

The write protect types available from the Logical Unit are dependent upon the media type installed. The correlation is shown in Table 65.

Table 65 – Examples of Write Protection Associated with Media Types

Media	Software Write Protect until Power-down (SWPP)	Cartridge Write Protect (CWP)	Media Specific Write Inhibit (MSWI)	Persistent Write Protect (PWP)	Write Inhibit DCB (WDCB)
CD-RW	√				
DCCD-RW	√				
DVD-RAM	√	√	√	√	
DVD-RW	√			√	
DVD+RW	√				√
Others that possess the Removable Disk Profile	√	√		√	

NOTE 1: Based upon media type and format specifications, certain writing may be permitted when PWP is set to true.

4.8.2 SWPP

If the Logical Unit supports Software Write Protect, the Write Protect Feature (0004h) shall be present and the SSWPP bit shall be set to one, however the feature need not be current.

If the SWPP bit is supported in the Timeout and Protect Page, then SWPP status may be read using the MODE SENSE (10) command and set or cleared by using the MODE SELECT (10) command.

The status of SWPP may also be read by using the READ DVD STRUCTURE command with format field = C0h.

4.8.3 CWP

If the Logical Unit supports Cartridge Write Protect, the Write Protect Feature (0004h) need not be present.

The Write-Inhibit hole is the mechanical switch/tab on a cartridge. When this hole is closed, the Logical Unit may write/modify information according to the other write protection conditions. When this hole on a cartridge is open, the logical unit shall not write/modify/initialize any information on the disc (including user data, defect management information and Write-inhibit flag).

The Initiator may read the Write-inhibit hole condition as the CWP bit value using the READ DVD STRUCTURE command with Format code C0h or 09h.

4.8.4 MSWI

A Logical Unit with DVD-RAM write capability, may elect to disallow writing when certain DVD-RAM media types are mounted without a cartridge. This is the Media Specific Write Inhibit case.

If the Logical Unit supports Media Specific Write Inhibit, the Write Protect Feature (0004h) need not be present.

The Initiator may read the MSWI status by using the READ DVD STRUCTURE command with Format code C0h or 09h.

4.8.5 PWP

If the Logical Unit supports Persistent Write Protect, the Write Protect Feature (0004h) shall be present. The Write Protect Feature shall be current when a media capable of accepting PWP is mounted and ready.

When the feature is present and current, the READ DVD STRUCTURE command, with format code = C0h, is used to determine the status of the write protection. When the feature is present and current, the SEND DVD STRUCTURE command, with format code = C0h, is used to change the status of the write protection.

4.8.6 WDCB

In the case of DVD+RW (and DVD+MRW), write inhibit is implemented with a Write Inhibit DCB (WDCB). The WDCB provides for exactly one of 4 different write inhibits: no write inhibit, write inhibit the entire disc, write inhibit the data zone only, or write inhibit only the LBA space of defect managed area (disallows commands that direct the Logical Unit to perform writing, but allows relocation during reading). The Initiator may choose to protect write access to the WDCB by use of a password.

The WDCB may be read using the READ DVD STRUCTURE command with format code = 30h. The WDCB may be written only by using the SEND DCB STRUCTURE command with format code = 30h. An existing WDCB may be deleted only by using the SEND DCB STRUCTURE command with format code = 30h. For details, see 6.27.3.19 and 6.39.5.

When the entire media is write protected by a WDCB, writing the WDCB via the SEND DVD STRUCTURE is the only writing permitted.

The WDCB may be password protected. If a WDCB is password protected, WDCB write protect status (or the password) may be changed only when the Initiator presents the correct password. If every byte of the password is ever set to FFh, the media shall become permanently write protected. This means that even formatting is not permitted.

4.8.7 Event Reporting

When Write Protection status of mounted medium and/or logical unit is changed (e.g. all of Write protections are cleared or one of them is set to active), then any Feature that allows erasing/formatting/ writing on the media is changed. In such a case an Operational Change Event shall be generated.

4.8.8 Error reporting

When a media is Write Protected, the Logical Unit shall terminate with CHECK CONDITION status, any command that might cause erasing/formatting/writing on the media. The SENSE KEY shall be set to WRITE PROTECT, ASC shall be set to WRITE PROTECTED, and the ASCQ shall be set according to Table 66.

Table 66 – Write Protect ASCQ Reporting

Write Protect Status According to READ DVD STRUCTURE, format C0h				ASCQ
SWPP	CWP	MSWI	PWP	
1	-	-	-	LOGICAL UNIT SOFTWARE WRITE PROTECTED
0	1	-	-	HARDWARE WRITE PROTECTED
0	0	1	-	NO ADDITIONAL SENSE CODE QUALIFIER
0	0	0	1	PERSISTENT WRITE PROTECTED

In the case that the media is protected by a WDCB, the ASCQ setting is different. See Table 67.

Table 67 – WDCB Write Protect ASCQ Reporting

Write Attempted when	ASCQ
The sector address is in a protected range	NO ADDITIONAL SENSE CODE QUALIFIER
The WDCB password contains FFh in each byte	PERMANENT WRITE PROTECTED

4.9 Changer Model

4.9.1 General

The changer is a Feature of a MM device. It shall support two (2) additional commands, MECHANISM STATUS (6.11) and LOAD/UNLOAD MEDIUM (6.10).

A changer device provides a storage area for more than one MM Disc. This storage area contains multiple areas called slots. Each slot contains exactly one disc. Once a disc has been placed into a given slot, it becomes locked in that position. This standard provides no capability to move a disc from one slot to another. Thus when a Disc has been moved from a given slot into the playing position, it may only be moved back into the slot that it came from. This shall be followed even if power is lost while a Disc is in the playing position or while it was being moved.

There are two basic types of changer mechanisms, one that has individually addressable eject and load capability and another that uses a magazine to hold the discs. In the former, individual discs may be changed, while in the latter all the stored discs shall be changed at one time.

Any time a disc or magazine is removed or installed from the changer, the device shall generate a Unit Attention Condition. After the Initiator detects the unit attention condition on a known changer device, the Initiator may issue a MECHANISM STATUS Command. This provides the Initiator with information on what disc is present or was changed.

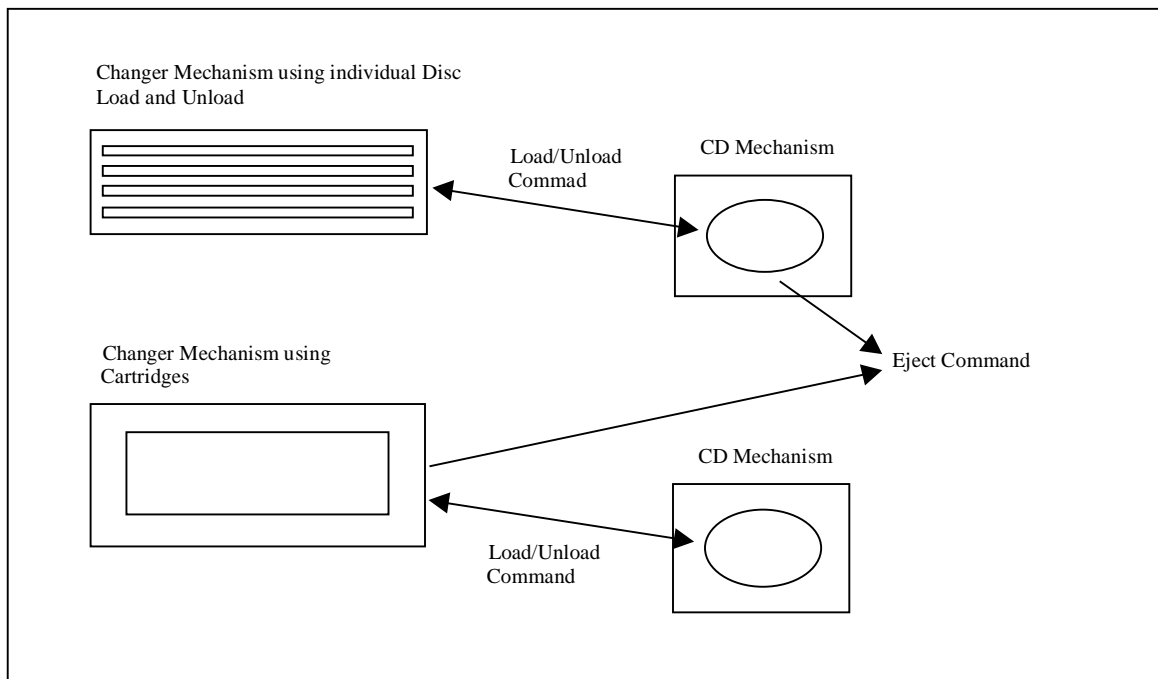

Figure 45 – Media Changer Mechanism Model

4.9.2 Side definition

4.9.2.1 Overview

As part of the DVD specifications, there is a type of media supported that includes data on more than one side of the Disc. This allows devices that are capable of automatically changing sides. For MM Devices, there is an optional capability to select each side of the Disc. Although this is not normally considered a changer type of operation, the two sides to the Disc are independent and changer like functions are a good match for selecting sides. When the Logical Unit supports this functionality, each physical slot has two logical slots. e.g., slot 0 represents one side of the Disc, and slot 1 represents the other side.

There are two fundamental techniques used to select each side of DVD media. The first is the most space efficient. It simply moved the Pick Up (laser unit used to read the disc) to the other side. This does add complexity to the laser mechanism to be able to position it on either the bottom or top of the media. The second approach is to flip the media over.

For a Logical Unit that supports changing sides (see Table 157), the number of Slots reported shall be even, and every other slot shall be an alternating side.

4.9.2.2 Side Changing Only Logical Unit

A Logical Unit that is capable of changing the side of the Disc, but does not have separate Slots from the playing position, reports that it has a Mechanism type that is not a changer, but also reports Side Change Capable. This style of Logical Unit still uses the LOAD/UNLOAD MEDIUM command to change the currently selected side. The Logical Unit shall report two slots available.

When the Logical Unit is able to only change sides, and not discs, it does not perform any action. This appears to the Initiator as a Logical Unit with a Delayed Load type of operation.

A DVD Logical Unit that supports changing sides is not able to report if there is actually data on both sides until each side has been read.

4.9.2.3 Attention Conditions for Sided Discs

Devices that support changing sides shall set sense bytes SK/ASC/ASCQ to UNIT ATTENTION/NOT READY TO READY CHANGE/MEDIUM MAY HAVE CHANGED for changes that involve disc loading.

4.9.2.4 Error Conditions for Sided Discs

Devices that support changing disc sides shall set sense bytes SK/ASC/ASCQ to NOT READY/NO REFERENCE POSITION FOUND to report when the currently selected side does not contain valid data.

4.9.2.5 Initialization

The Changer shall perform its initialization routine at power on or hard reset.

“Initializing Changer” is a process that refers to gathering the information that is necessary to respond to the MECHANISM STATUS command. If a changer is in the process of initializing when it receives a MECHANISM STATUS command, it responds immediately and provides no slot table information (only the Header).

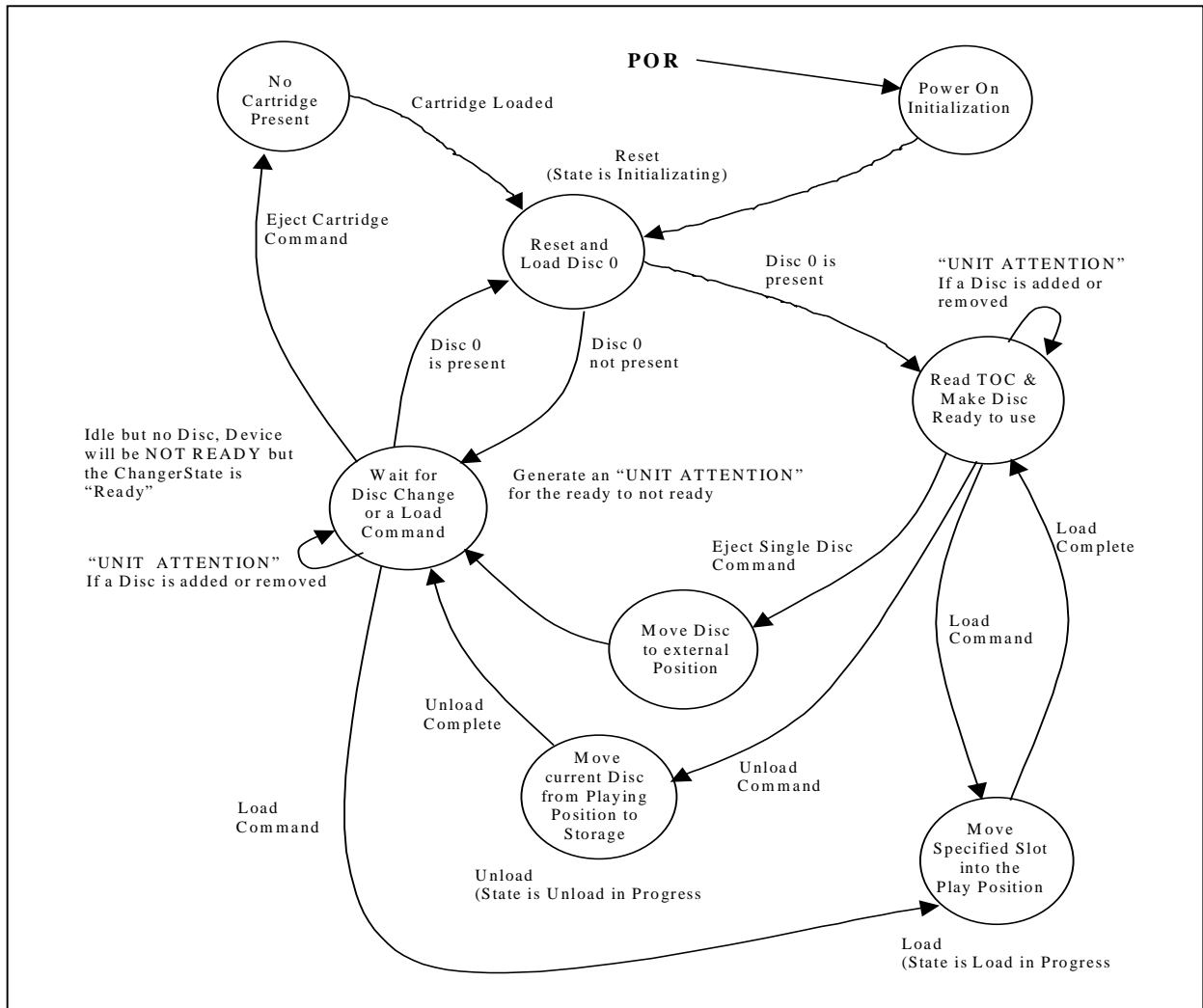

Figure 46 – Changer State Diagram

4.9.3 Changer Addressing

Several Changer specific commands use addresses called “Slots.”

If any commands related to Changer operations are implemented, then all the Changer commands shall be implemented. To determine if a Logical Unit is a changer type device, the Embedded Changer Feature shall be reported in response to an appropriate GET CONFIGURATION command.

4.9.4 Automatic Load and Unload Operations

After initialization is complete the changer shall have Disc 0 loaded into the play position. This enables drivers that are not changer aware to work with a changer device as if it were a normal single MM device. This also ensures compatibility with a Bootable MM. In support of this goal the changer shall also load and unload (Eject) default Disc 0 if the changer supports loading and unloading (Ejecting) individual Discs unless otherwise commanded by the use of one of the changer specific Load/Unload commands.

When a LOAD/UNLOAD command is received and a Disc is present in the Playing position, it shall be unloaded automatically before the specified Load operation is performed.

4.9.5 Delayed Disc load operation

MM Changer Devices may either move a disc into the playing position immediately upon receipt of a LOAD command, or delay the loading of the disc until a media access command is received. It is recommended that the device not load discs into the playing position until data from a disc that is not cached is requested from the Initiator.

Initiator drivers should expect to encounter load mechanism delays on media accesses in addition to the spin up and seek delays normally introduced with these commands.

If the device supports delayed loading and the selected disc is not in the play position, then the commands listed in Table 68 shall move the selected disc into the play position when data that has not been cached has been requested by the Initiator.

Table 68 – Commands that shall not cause delayed loads to occur

Commands
PLAY AUDIO (10)
PLAY AUDIO MSF
READ (10)
READ (12)
READ CD
READ CD MSF
READ CD-ROM CAPACITY
READ SUB-CHANNEL
READ TOC
SCAN

If the device supports delayed loading and the selected disc is not in the play position, then the following commands shall load the selected disc into the play position before execution of the command (See Table 69).

Table 69 – Commands that may cause delayed loads to occur

Command
SEEK
START STOP UNIT (LoEj = 1)

If the device supports delayed loading and the selected disc is not in the play position, then the following commands shall not move the selected disc into the play position. (See Table 70)

Table 70 – Commands that should not cause delayed loads to occur

Command
STOP PLAY/SCAN
START STOP UNIT (LoEj=0)
TEST UNIT READY
INQUIRY
MECHANISM STATUS
MODE SELECT
MODE SENSE
PREVENT ALLOW MEDIUM REMOVAL
REQUEST SENSE
SET CD SPEED

4.9.6 Prevent / Allow processing

There are two techniques for Prevent / Allow: either all the discs shall be prevented from being ejected by the user or each disc individually shall be prevented. If the device reports support for Software Slot Selection, then each slot shall be individually controlled by the Prevent / Allow command. Changer devices that use a Magazine and not individually controlled slots should not report the Software Slot Selection capability.

4.9.7 Error Reporting for Changers

If any of the following conditions occur during the execution of a command, the Changer shall return CHECK CONDITION status. The appropriate SK/ASC/ASCQ values shall be set. Table 71 lists some error conditions and the applicable sense keys. The list does not provide an exhaustive enumeration of all conditions that may cause the CHECK CONDITION status.

Table 71 – Error Conditions and Sense Keys for Changer Mechanisms

Condition	Sense Key
Invalid Slot Number	ILLEGAL REQUEST
Unsupported option requested	ILLEGAL REQUEST
Load or Unload to invalid slot or no Disc in source location	ILLEGAL REQUEST
Device Reset or medium change since last command	UNIT ATTENTION
Self diagnostic failed	HARDWARE ERROR

In the case of an invalid Slot number, the sense data information field shall be set to the Slot number of the first invalid address.

Attempts to eject a Disc if the changer type is magazine and there is a Disc in the playing position shall be rejected with a CHECK CONDITION status and SK/ASC/ASCQ values shall be set to ILLEGAL REQUEST/MECHANICAL POSITIONING OR CHANGER ERROR.

5 Features and Profiles for Multi-Media Devices

5.1 Introduction

A Multimedia Logical Unit may appear differently to Initiators depending on the type of media that is currently installed. In order to provide the Initiator with information about which commands and mode pages are needed to properly utilize the Logical Unit, the GET CONFIGURATION command returns a detailed list of descriptors that describe the situational capabilities and behaviors of the Logical Unit. These descriptors are referred to as “Features” and “Profiles”.

A Feature is a set of commands, Mode Parameters and behaviors that specify the capabilities of a Logical Unit and its associated medium. One or more Features may be supported by a particular Logical Unit. In general, Features associated with device capabilities are static while Features associated with medium capabilities are dynamic. While Features are optional, the commands and mode parameters specified by a Feature are mandatory. If a particular Feature is reported, the Logical Unit shall implement all of the commands and mode parameters of that Feature.

Profiles define a base set of Features for Logical Units. Logical Units that list a Profile as current shall support all Features required by that Profile, however, not all Features may be current. Logical Units may support Features in addition to those required by the Profile. A single device may implement more than one Profile, and more than one Profile may be active at any given time. All required Features might not be current, depending on the medium installed. If a device is not ready (i.e., Not Ready response to a TEST UNIT READY command), no Profile shall be current.

5.2 Features

5.2.1 Overview

To determine the Features supported by the Logical Unit, the Initiator should issue a GET CONFIGURATION command (See 6.6). In response to this GET CONFIGURATION command the Logical Unit shall respond with data as shown in Table 72. Response data consists of a header field and zero or more variable length Feature descriptors. The format of the Feature Header is shown in Table 73.

Table 72 – GET CONFIGURATION response data format

Bit	7	6	5	4	3	2	1	0
Byte								
0 – 7	Feature Header							
8 – n	Feature Descriptor(s)							

Table 73 – Feature Header

Bit	7	6	5	4	3	2	1	0
Byte								
0	(MSB) Data Length (LSB)							
1								
2								
3								
4	Reserved							
5	Reserved							
6	(MSB) Current Profile (LSB)							
7								

The Data Length field indicates the amount of data available given a sufficient allocation length following this field. This length shall not be truncated due to an insufficient Allocation Length. If the

Data Length is greater than 65530 bytes, multiple GET CONFIGURATION commands with different Starting Feature Numbers are required for the Initiator to read all configuration data. This field is adjusted as appropriate for the given Starting Feature Number.

The Current Profile field shall indicate the Logical Unit's current Profile. The Logical Unit shall choose the most appropriate current Profile from the list of Profiles (see Table 78) with their CurrentP bit set. If there are no Profiles currently active, this field shall contain zero.

A Feature Descriptor shall describe each Feature supported by a Logical Unit. All Feature descriptors shall be a multiple of four bytes. The Feature Descriptor(s) generic format returned is defined in Table 74. Each individual Feature description is defined in the appropriate sub-clause.

Table 74 – Feature Descriptor generic format

Byte	Bit	7	6	5	4	3	2	1	0
0	(MSB)	Feature Code							
1		(LSB)							
2		Reserved		Version			Persistent	Current	
3		Additional Length							
4 – n		Feature Dependent Data							

The Feature Code field shall identify a Feature supported by the Logical Unit.

5.2.2 Version field

The Version field is reserved and shall be set to zero unless otherwise specified within the Feature Description. Future versions of a Feature shall be backward compatible; incompatible changes shall be included in a different Feature.

5.2.3 Persistent Bit

The Persistent bit, when set to zero, shall indicate that this Feature may change its current status. When set to one, shall indicate that this Feature is always active. The Logical Unit shall not set this bit to one if the Current bit is, or may become, zero.

e.g., suppose that the feature is uniquely associated with a group of media types, each of which is removable. In that case, the Current bit shall become zero whenever the type of media mounted is not associated with the feature. For such a feature, the Persistent bit shall be set to zero.

5.2.4 Current Bit

The Current bit, when set to zero, indicates that this Feature is not currently active and that the Feature Dependent Data may not be valid. When set to one, this Feature is currently active and the Feature Dependent Data is valid.

e.g., suppose that the feature is uniquely associated with a group of media types, each of which is removable. In that case, the Current bit shall become zero whenever the type of media mounted is not associated with the feature.

5.2.5 Additional Length Field

The Additional Length field indicates the number of Feature specific bytes that follow this header. This field shall be an integral multiple of 4.

5.2.6 Feature Codes

Features are the smallest set of commands, pages, and behavior that may be implemented. Each Feature is assigned a unique code or number to identify the Feature. Feature codes are shown in Table 75. The maximum number of Feature sets is 65536 and the Feature code value of 0000h is reserved for the list of Profiles supported by the Logical Unit.

Table 75 – Feature Codes

Feature Code	Feature Name	Description
0000h	Profile List	A list of all Profiles supported by the Logical Unit
0001h	Core	Mandatory behavior for all devices
0002h	Morphing	Ability to notify Initiator about operational changes and accept Initiator requests to prevent operational changes.
0003h	Removable Medium	The medium may be removed from the device
0004h	Write Protect	The ability to control Write Protection status
0005h – 000Fh	Reserved	
0010h	Random Readable	Read ability for storage devices with random addressing
0011h – 001Ch	Reserved	-
001Dh	Multi-Read	The Logical Unit is able to read all CD media types; based on OSTA MultiRead
001Eh	CD Read	The ability to read CD specific structures
001Fh	DVD Read	The ability to read DVD specific structures
0020h	Random Writable	Write support for randomly addressed writes
0021h	Incremental Streaming Writable	Write support for sequential recording
0022h	Sector erasable	Write support for erasable media and media that requires an erase pass before overwrite.
0023h	Formattable	Support for formatting of media.
0024h	Defect Management	Ability of the Logical Unit/media system to provide an apparently defect-free space.
0025h	Write Once	Write support for write-once media that is writable in random order.
0026h	Restricted Overwrite	Write support for media that shall be written from Blocking boundaries only.
0027h	CD-RW CAV Write	The ability to write high speed CD-RW media
0028h	MRW	The ability to recognize and read and optionally write MRW formatted media
0029h	Enhanced Defect Reporting	The ability to control RECOVERED ERROR reporting
002Ah	DVD+RW	The ability to recognize, read and optionally write DVD+RW media
002Bh	DVD+R	The ability to read DVD+R recorded media formats
002Ch	Rigid Restricted Overwrite	Write support for media that is required to be written from Blocking boundaries with length of integral multiple of Blocking size only.
002Dh	CD Track at Once	Ability to write CD with Track at Once recording
002Eh	CD Mastering	The ability to write CD with Session at Once or Raw write methods.

Table 75 – Feature Codes (cont)

Feature Code	Feature Name	Description
002Fh	DVD-R/-RW Write	The ability to write DVD specific structures
0030h	DDCD Read	The ability to read user data from DDCCD blocks.
0031h	DDCD-R Write	The ability to write and read DDCCD-R media.
0032h	DDCD-RW Write	The ability to write and read DDCCD-RW media
0033h – 0036h	Reserved	-
0037h	CD-RW Media Write Support	The ability to report CD –RW media sub-types that are supported for write
0038h – 00FFh	Reserved	
0100h	Power Management	Initiator and device directed power management
0101h	SMART	Ability to perform Self Monitoring Analysis and Reporting Technology
0102h	Embedded Changer	Single mechanism multiple disc changer
0103h	CD Audio analog play	Ability to play audio CDs via the Logical Unit's own analog output
0104h	Microcode Upgrade	Ability for the device to accept new microcode via the interface
0105h	Timeout	Ability to respond to all commands within a specific time
0106h	DVD-CSS	Ability to perform DVD CSS/CPPM authentication and RPC
0107h	Real Time Streaming	Ability to read and write using Initiator requested performance parameters
0108h	Logical Unit serial number	The Logical Unit has a unique identifier.
0109h	Reserved	-
010Ah	Disc Control Blocks	The ability to read and/or write Disc Control Blocks
010Bh	DVD CPRM	The Logical Unit supports DVD CPRM authentication
010Ch	Firmware Information	Firmware creation date report
010Dh – 01FFh	Reserved	-
0200h – FEFFh	Reserved	-
FF00h – FFFFh	Vendor Specific	-

5.3 Feature Definitions

5.3.1 Profile List Feature (0000h)

This Feature identifies Profiles supported by the Logical Unit. The Profile List descriptor returned is defined in Table 76. Profiles are defined as collections of Features and provide a method to quickly determine the Logical Unit's type. This Feature is always current, even if none of the Profiles listed are current.

Table 76 – Profile List Descriptor Format

Bit	7	6	5	4	3	2	1	0
Byte								
0	(MSB) Feature Code = 0000h (LSB)							
1								
2	Reserved		Version			Persistent	Current	
3	Additional Length							
4 – n	Profile Descriptor(s)							

The Feature Code field shall be set to 0000h.

The Version field is reserved and shall be set to zero. Future versions of a Feature shall be backward compatible; incompatible changes shall be included in a different Feature.

The Persistent bit shall be set to one to indicate that the reporting of the Profile list is always supported.

The Current bit shall be set to one.

The Additional Length field shall be set to ((number of Profile Descriptors) * 4).

The Profile Descriptors are shown in Table 77. All Profiles supported by the Logical Unit shall always be reported. Profile descriptors are returned in the order of preferred operation – most desirable to least desirable. e.g., a DVD-ROM that is also able to read a CD-ROM should list the DVD-ROM Profile first and the CD-ROM Profile second.

Table 77 – Profile Descriptor

Bit	7	6	5	4	3	2	1	0
Byte								
0	(MSB) Profile Number (LSB)							
1								
2	Reserved						CurrentP	
3	Reserved							

The Profile Number identifies a Profile to which the Logical Unit conforms (Table 78).

The CurrentP bit, when set to one, shall indicate that this Profile is currently active. If no medium is present, no Profile should be active. Multifunction devices shall select the most appropriate Profile(s), if any, to set as current. The most appropriate current Profile is also reported in the Feature Header (See Table 73).

Table 78 – Profile List

Profile Number	Profile Name	Description	Reference
0000h	Reserved	—	
0001h	Non-removable disk	Re-writable disk, capable of changing behavior	5.4.3
0002h	Removable disk	Re-writable; with removable media	5.4.4
0003h	MO Erasable	Magneto-Optical disk with sector erase capability	5.4.5
0004h	Optical Write Once	Optical write once	5.4.6
0005h	AS-MO	Advance Storage – Magneto-Optical	5.4.7
0006h – 0007h	Reserved	—	
0008h	CD-ROM	Read only Compact Disc capable	5.4.8
0009h	CD-R	Write once Compact Disc capable	5.4.9
000Ah	CD-RW	Re-writable Compact Disc capable	5.4.10
000Bh – 000Fh	Reserved	—	
0010h	DVD-ROM	Read only DVD	5.4.11
0011h	DVD-R Sequential Recording	Write once DVD using Sequential recording	5.4.12
0012h	DVD-RAM	Re-writable DVD	5.4.13
0013h	DVD-RW Restricted Overwrite	Re-recordable DVD using Restricted Overwrite	5.4.14
0014h	DVD-RW Sequential recording	Re-recordable DVD using Sequential recording	5.4.15
0015h – 0019h	Reserved	—	
001Ah	DVD+RW	DVD ReWritable	5.4.16
001Bh	DVD+R	DVD Recordable	5.4.17
001Ch – 001Fh	Reserved	—	
0020h	DDCD-ROM	Read only DDCD	5.4.18
0021h	DDCD-R	Write once DDCD	5.4.19
0022h	DDCD-RW	Re-Writable DDCD	5.4.20
0023h-002Fh	Reserved	—	
0030h-FFFEh	Reserved	—	
FFFFh	Logical Units Not Conforming to a Standard Profile	The Logical Unit does not conform to any Profile.	5.4.21

5.3.2 Core Feature (0001h)

This Feature identifies a Logical Unit that supports functionality common to all devices. The Feature descriptor response data to be returned to the Initiator is defined in Table 79.

Table 79 – Core Feature Descriptor Format

Byte	Bit	7	6	5	4	3	2	1	0
0	(MSB)	Feature Code = 0001h							
1		(LSB)							
2		Reserved		Version = 0001b			Persistent	Current	
3		Additional Length = 8							
4	(MSB)	Physical Interface Standard							
5									
6									
7									
8		Reserved							DBE
9		Reserved							
10		Reserved							
11		Reserved							

The Feature Code field shall be set to 0000h.

The Version Field shall be set to 0001b.

The Persistent bit shall be set to one.

The Current bit shall be set to one.

The Additional Length field shall be set to 8.

All Logical Units that conform to this standard shall implement the Core Feature set of commands specified in Table 80.

Table 80 – Core Feature Commands

Op Code	Command Description	Reference
12h	INQUIRY	6.9
46h	GET CONFIGURATION	6.6
4Ah	GET EVENT STATUS NOTIFICATION	6.7
55h	MODE SELECT (10)	6.12
5Ah	MODE SENSE (10)	6.13
03h	REQUEST SENSE	6.34
00h	TEST UNIT READY	6.48

The Physical Interface Standard field shall be set to a value selected from Table 81.

NOTE 10: It is possible that more than one physical interface exists between the Initiator and logical unit, e.g., an IEEE1394 to ATAPI bridge. A SCSI target may be unaware of the outer interface layers.

Table 81 – Physical Interface Standard

Physical Interface Standard	Description	Application
00000000h	Unspecified	
00000001h	SCSI Family	See Annex B
00000002h	ATAPI	See Annex A
00000003h	IEEE 1394 – 1995	See Annex C
00000004h	IEEE 1394A	See Annex C
00000005h	Fibre Channel	
00000006h	IEEE 1394B	See Annex C
00000007h	Serial ATAPI	See Annex A
00000008h	USB (both 1 and 2)	See Annex D
00000009h – 0000FFFEh	Reserved	
0000FFFFh	Vendor Unique	
00010000h – 0001FFFFh	Defined by INCITS	
00020000h – 0002FFFFh	Defined by SFF	
00030000h – 0003FFFFh	Defined by IEEE	
00040000h – FFFFFFFFh	Reserved	

When DBE is set to one, the Device Busy Event (see 6.7.2.7) shall be supported according to this standard. When Version is not 0000b, DBE shall be set to one.

5.3.3 Morphing Feature (0002h)

This Feature identifies the ability of the Logical Unit to notify an Initiator about operational changes and accept Initiator requests to prevent operational changes.

Support for this Feature is enabled using the PREVENT ALLOW MEDIUM REMOVAL command (Persistent Bit), and the media status is retrieved using the GET EVENT STATUS NOTIFICATION command.

The Feature descriptor response data to be returned to the Initiator is defined in Table 82.

Table 82 – Morphing Descriptor Format

Byte	Bit	7	6	5	4	3	2	1	0
0	(MSB)	Feature Code = 00002h							
1		(LSB)							
2		Reserved		Version = 0001b			Persistent	Current	
3		Additional Length = 04h							
4		Reserved					OCEvent	ASYNC	
5		Reserved							
6		Reserved							
7		Reserved							

The Feature Code field shall be set to 0002h.

The Version Field shall be set to 1h.

The Persistent bit shall be set to one.

The Current bit shall be set to one.

The Additional Length field shall be set to 4.

When the OCEvent bit is set to 1, the Operational Change Request/Notification Class Events of GET EVENT/STATUS NOTIFICATION Command shall be supported according to this standard. When Version is not 0000b, OCEvent shall be set to one.

The ASYNC bit, when set to zero, indicates that the Logical Unit supports only the polling implementation of GET EVENT STATUS NOTIFICATION. When set to one, indicates that the Logical Unit supports both polling and asynchronous GET EVENT STATUS NOTIFICATION. ATAPI implementations shall set ASYNC to 0.

Logical Units that support this Feature shall implement the commands specified in Table 83.

Table 83 – Morphing Feature Commands

Op Code	Command Description	Reference
46h	GET CONFIGURATION	6.6
4Ah	GET EVENT STATUS NOTIFICATION	6.7
1Eh	PREVENT ALLOW MEDIUM REMOVAL (with Persistent bit set to one)	6.18

5.3.4 Removable Medium Feature (0003h)

This Feature identifies a Logical Unit that has a medium that is removable. Media shall be considered removable if it is possible to remove it from the loaded position, i.e., a single mechanism changer, even if the media is captive to the changer.

The Logical Unit shall generate Events for media changes. Event Notification Class 4 (Media Events) shall be supported. This includes reporting user requests to load/eject the medium.

The Feature descriptor response data to be returned is defined in Table 84.

Table 84 – Removable Medium Feature Descriptor Format

Byte	Bit	7	6	5	4	3	2	1	0
0	(MSB)	Feature Code = 0003h							
1		(LSB)							
2		Reserved		Version			Persistent	Current	
3		Additional Length = 04h							
4		Loading Mechanism Type		Reserved	Eject	Pvnt Jmpr	Reserved	Lock	
5		Reserved							
6		Reserved							
7		Reserved							

The Feature Code field shall be set to 0003h.

The Version Field shall be set to 0h.

The Persistent bit shall be set to one.

The Current bit shall be set to one.

Event Class 4 shall be supported.

The Additional Length field shall be set to 4.

If Lock is set to zero, there is no locking mechanism for locking the medium into the Logical Unit. If Lock is set to one, the Logical Unit is capable of locking the media into the Logical Unit.

The Pvnt Jmpr bit, when set to zero, shall indicate that the Prevent Jumper is present. The Logical Unit shall power up to the allow state and locking the Logical Unit with the PREVENT ALLOW MEDIUM REMOVAL command shall not prevent insertion of the media. When set to one, the Prevent Jumper is not present. The Logical Unit shall power up to the prevent state (locked) and shall not accept new media or allow the ejection of media already loaded until a PREVENT ALLOW MEDIUM REMOVAL (allow) command is issued. The Pvnt Jmpr bit shall not change state, even if the physical jumper is added or removed during operation. Logical Units that do not have a Prevent Jumper available should set this bit to 0 to indicate that the Logical Unit behaves as described for a jumper being present.

The Eject bit, when set to zero, indicates that the device is unable to eject the medium or magazine via the normal START/STOP command with the LoEj bit set. When set to one, indicates that the device is able to eject the medium or magazine.

The Loading Mechanism Type field (Table 85) shall be set according to the Eject bit.

Table 85 – Loading Mechanism Type

Loading Mechanism Type	Description
000b	Caddy/Slot type loading mechanism
001b	Tray type loading mechanism
010b	Pop-up type loading mechanism
011b	Reserved
100b	Embedded changer with individually changeable discs
101b	Embedded changer using a magazine mechanism
110b – 111b	Reserved

Logical Units that support the Removable Medium Feature shall implement the commands specified in Table 86.

Table 86 – Removable Medium Feature Commands

Op Code	Command Description	Reference
BDh	MECHANISM STATUS	6.11
1Eh	PREVENT ALLOW MEDIUM REMOVAL with the Persistent Prevent bit set to zero.	6.18
1Bh	START STOP UNIT and load eject (LOEJ) bit	6.45

If a changer type Logical Unit uses media status operation, it shall use the following variations. If the changer Logical Unit supports individual slot load and unload capability, the slot number(s) exhibiting the media status change shall be reported in the slot fields of the Media Status Event Data. If the changer Logical Unit uses a magazine load mechanism, the slot fields shall be set to the start and end slot numbers present in the magazine.

For non-immediate GET EVENT STATUS NOTIFICATION commands, the Initiator should use exactly one GET EVENT STATUS NOTIFICATION request for the entire changer Logical Unit. The Logical Unit shall respond as indicated in the Asynchronous Operation section above, indicating the slot information in the Request Sense Data as described above.

5.3.5 Write Protect Feature (0004h)

This Feature identifies reporting capability and changing capability for Write protection status of the Logical Unit.

The Write Protect Feature descriptor response data to be returned to the Initiator is defined in Table 87.

Table 87 – Write Protect Feature Descriptor

Byte	Bit	7	6	5	4	3	2	1	0
0	(MSB)	Feature Code = 0004h							
1		(LSB)							
2		Reserved		Version = 0001b			Persistent	Current	
3		Additional Length = 04h							
4		Reserved				WDCB	SPWP	SSWPP	
5		Reserved							
6		Reserved							
7		Reserved							

The Feature Code field shall be set to 0004h.

The Version Field shall be set to 1h.

The Persistent bit shall be defined as in 5.2.3.

The Current bit, when set to one, indicates that Logical Unit is capable of changing PWP status on the medium surface. This bit shall be set to zero if the Logical Unit is unable to set/release the PWP status. The reporting capability of the Write Protect status is persistent and shall be supported regardless of the setting of the Current bit.

The Additional Length field shall be set to 04h.

The WDCB bit indicates that the Logical Unit supports reading/writing the Write Inhibit DCB on DVD+RW media. If WDCB is set to one, the READ/SEND DVD STRUCTURE with format code = 30h shall be supported.

The Supports PWP (SPWP) bit indicates that the Logical Unit supports set/release PWP status. If SPWP bit is set to one, the SEND DVD STRUCTURE command with Format = C0h shall be supported.

The Supports SWPP (SSWPP) bit indicates that the Logical Unit supports SWPP bit of Timeout & Protect Mode Page (1Dh). This bit does not affect Current bit of this Feature Descriptor. If SSWPP bit is set to one, the Logical Unit shall support SWPP bit of Timeout & Protect Mode Page.

If Logical Unit supports reporting Write Protection status but does not support changing, the Logical Unit returns this Feature descriptor, however the Current bit is never set to one in the descriptor.

Logical Units with installed medium that support this Feature shall implement the commands listed in Table 88.

Table 88 – Write Protect Feature Commands

Op Code	Command Description	Reference
ADh	READ DVD STRUCTURE	6.27
	Format codes C0h and FFh when SPWP = 1	
	Format codes 30h and FFh when WDCB = 1	
BFh	SEND DVD STRUCTURE with Format code C0h	6.39
	Format codes C0h and FFh when SPWP = 1	
	Format codes 30h and FFh when WDCB = 1	

5.3.6 Random Readable Feature (0010h)

This Feature identifies a Logical Unit that is able to read data from logical blocks specified by Logical Block Addresses. There is no requirement that the addresses, in sequences of reads, occur in any particular order.

The Feature descriptor response data to be returned to the Initiator is defined in Table 89.

Table 89 – Random Readable Feature Descriptor Format

Byte	Bit	7	6	5	4	3	2	1	0
0	(MSB)	Feature Code = 0010h							
1		(LSB)							
2		Reserved		Version				Persistent	Current
3		Additional Length = 08h							
4	(MSB)	Logical Block Size							
5									
6									
7									
8	(MSB)	Blocking							
9		(LSB)							
10		Reserved							PP
11		Reserved							

The Feature Code field shall be set to 0010h.

The Version Field shall be set to 0h.

The Persistent bit shall be defined as in 5.2.3.

The Current bit shall be defined as in 5.2.4.

The Additional Length field shall be set to 8.

The Logical Block Size shall be set to the number of bytes per logical block. This is the value reported by the READ CAPACITY command.

The Blocking field shall indicate the number of logical blocks per device readable unit. For most hard disks, this value is 1. For DVD devices, this number is 10h. Reads of any sector or sector count, shall be allowed. If there is more than one Blocking on the medium possible, the Blocking field shall be set to zero. See the READ TRACK INFORMATION command for more information.

The PP (Page Present) bit, when set to zero, shall indicate that the Read/Write Error Recovery Mode Page may not be present. When set to one, shall indicate that the Read/Write Error Recovery Mode Page is present.

If the PP bit in the Feature Descriptor is set, the TB, RC, PER, DTE, and DCR bits of the Read/Write Error Recovery Mode Page shall be supported. An Error Recovery Parameter field of 0 in the Read/Write Error Recovery Mode Page shall be supported. Support for other bits and values in the Read/Write Error Recovery Mode Page are optional.

Logical Units that claim the Random Readable Feature shall implement the commands specified in Table 90.

Table 90 – Random Readable Feature Commands

Op Code	Command Description	Reference
25h	READ CAPACITY	6.23
28h	READ (10)	6.19

Logical Units that claim the Random Readable Feature shall implement the mode pages as specified in Table 91.

Table 91 – Random Readable Feature Mode Pages

Page Code	Mode Page	Reference
01h	Read/Write Error Recovery Parameters, TB, RC, PER, DTE, and DCR bits (mandatory only when PP is set to one)	7.2

5.3.7 Multi-Read Feature (001Dh)

The Logical Unit shall conform to the OSTA Multi-Read specification 1.00, with the exception of CD Play capability (the CD Audio Feature is not required).

The Feature descriptor response data to be returned to the Initiator is defined in Table 92.

Table 92 – Multi-Read Feature Descriptor Format

Byte	Bit	7	6	5	4	3	2	1	0	
0	(MSB)	Feature Code = 001Dh								
1										(LSB)
2		Reserved		Version			Persistent	Current		
3		Additional Length = 00h								

The Feature Code field shall be set to 001Dh.

The Version Field shall be set to 0h.

The Persistent bit shall be defined as in 5.2.3.

The Current bit shall be defined as in 5.2.4.

The Additional Length field shall be set to 00h.

Logical Units that support the Multi-Read Feature shall implement the commands specified in Table 93

Table 93 – Multi-Read Feature Commands

Op Code	Command Description	Reference
28h	READ (10)	6.19
BEh	READ CD	6.24
51h	READ DISC INFORMATION	6.26
52h	READ TRACK INFORMATION	6.31

5.3.8 CD Read Feature (001Eh)

This Feature identifies a Logical Unit that is able to read CD specific information from the media and is able to read user data from all types of CD blocks.

The Feature descriptor response data to be returned to the Initiator is defined in Table 94.

Table 94 – CD Read Feature Descriptor Format

Byte	Bit	7	6	5	4	3	2	1	0
0	(MSB)	Feature Code = 001Eh							
1		(LSB)							
2		Reserved		Version			Persistent	Current	
3		Additional Length = 04h							
4		DAP	Reserved				C2 Flags	CD-Text	
5		Reserved							
6		Reserved							
7		Reserved							

The Feature Code field shall be set to 001Eh.

The Version field shall be set to 2h.

The Persistent bit shall be defined as in 5.2.3.

The Current bit shall be defined as in 5.2.4.

The Additional Length field shall be set to 04h.

If DAP is set to one, the READ CD and READ CD MSF commands support the DAP bit in bit 1, byte 1 of the CDB.

The C2 Flags, when set to one, indicates the Logical Unit supports the C2 Error Pointers. When set to zero the Logical Unit does not support C2 Error Pointers.

The CD-Text bit, when set to one, indicates the Logical Unit supports Format Code 5h of the READ TOC/PMA/ATIP command. When set to zero, CD-Text is not supported.

Logical Units that read CD-ROM media shall support the commands specified in Table 95.

Table 95 – CD READ Feature Commands

Op Code	Command Description	Reference
BEh	READ CD	6.24
B9h	READ CD MSF	6.25
43h	READ TOC/PMA/ATIP (Format codes 0h, 1h, and 2h shall be supported. If the CD-TEXT bit is set to one, Format code 5h shall also be supported.)	6.30

5.3.9 DVD Read Feature (001Fh)

This Feature identifies a Logical Unit that is able to read DVD specific information from the media.

The Feature descriptor response data to be returned to the Initiator is defined in Table 96.

Table 96 – DVD Read Feature Descriptor Format

Byte	Bit	7	6	5	4	3	2	1	0
0	(MSB)	Feature Code = 001Fh							
1		(LSB)							
2		Reserved			Version			Persistent	Current
3		Additional Length = 00h							

The Feature Code field shall be set to 001Fh.

The Version Field shall be set to 0h.

The Persistent bit shall be defined as in 5.2.3.

The Current bit shall be defined as in 5.2.4.

The Additional Length field shall be set to zero.

Logical Units that read DVD-ROM media shall support the commands specified in Table 97.

Table 97 – DVD READ Feature Commands

Op Code	Command Description	Reference
28h	READ (10)	6.19
A8h	READ (12)	6.20
ADh	READ DVD STRUCTURE (format codes 00h, 01h, 03, and 04h)	6.27
43h	READ TOC/PMA/ATIP (Supports Format codes 0h and 1h.)	6.30

5.3.10 Random Writable Feature (0020h)

This Feature identifies a Logical Unit that is able to write data to logical blocks specified by Logical Block Addresses. There is no requirement that the addresses in sequences of writes occur in any particular order. The Feature descriptor response data to be returned to the Initiator is defined in Table 98.

Table 98 – Random Writable Feature Descriptor Format

Byte	Bit	7	6	5	4	3	2	1	0
0	(MSB)	Feature Code = 0020h							
1		(LSB)							
2		Reserved		Version			Persistent	Current	
3		Additional Length = 0Ch							
4	(MSB)	Last Logical Block Address							
5									
6									
7									
8	(MSB)	Logical Block Size							
9									
10									
11									
12	(MSB)	Blocking							
13									
14		Reserved							PP
15		Reserved							

The Feature Code field shall be set to 0020h.

The Version field shall be set to 1h.

The Persistent bit shall be defined as in 5.2.3.

The Current bit shall be defined as in 5.2.4.

The Additional Length field shall be set to 0Ch.

The Last Logical Block Address is the logical block address of the last addressable block on the medium.

The Logical Block Size field specifies the number of bytes per logical block. This value shall be the same as reported by the Random Readable Feature and the READ CAPACITY command.

The Blocking field shall indicate the number of logical blocks per writable unit. For DVD devices, this number is 10h. Writes of any sector or sector count, shall be allowed. If there is more than one Blocking on the medium possible, the Blocking field shall be set to zero. See the READ TRACK INFORMATION command for more information.

When the PP (Page Present) bit is set to zero, the Logical Unit does not claim to support the Read/Write Error Recovery Mode Page. When PP is set to one, the Read/Write Error Recovery Mode Page shall be supported.

Logical Units that may be used as a random writable block device shall implement the commands as specified in Table 99.

Table 99 – Random Writable Feature Commands

Op Code	Command Description	Reference
25h	READ CAPACITY	6.23
2Ah	WRITE (10)	6.50
2Eh	WRITE AND VERIFY (10)	6.52
35h	SYNCHRONIZE CACHE (The Immediate bit shall be supported)	6.47

Logical Units that claim the Random Writable Feature shall implement the mode pages as specified in Table 100.

Table 100 – Random Writable Feature Mode Pages

Page Code	Mode Page	Reference
01h	Read/Write Error Recovery Parameters (mandatory only when PP is set to one)	7.2

5.3.11 Incremental Streaming Writable (0021h)

This Feature identifies a Logical Unit that is able to write data to a contiguous region, and is able to append data to a limited number of locations on the media. On CD media, this is known as packet recording and on DVD media it is known as Incremental Recording.

The Feature descriptor response data is defined in Table 101.

Table 101 – Incremental Streaming Writable Feature Descriptor Format

Byte	Bit	7	6	5	4	3	2	1	0
0	(MSB)	Feature Code = 0021h							
1		(LSB)							
2		Reserved		Version			Persistent	Current	
3		Additional Length							
4	(MSB)	Data Block Types Supported							
5		(LSB)							
6		Reserved							BUF
7		Number of Link Sizes							
8 – n		Link Size							
n - ?		Pad							

The Feature Code field shall be set to 0021h.

The Version field is set to 1h.

The Persistent bit shall be defined as in 5.2.3.

The Current bit shall be defined as in 5.2.4.

The Additional Length field shall be set to 4 + (Number of Link Sizes) + (Number of Pad bytes).

The Data Type Supported field is a bit field that identifies the supported Data Type. A bit set to zero indicates the Data Type is not supported. A bit set to one indicates the Data Type is supported. Bit 0 equates to Data Type 0 and bit 15 equates to Data Type 15, etc.

The BUF bit, if set to 1, shall indicate that the Logical Unit is capable of zero loss linking.

The Number of Link Sizes shall specify the number of link sizes available for the current media. For CD and DDCD media, this field should be 1. For DVD-R, this field should be 2.

Each Link Size field shall indicate the number of logical blocks per link. Links occur on sequentially written media between independent write operations. The link size does not include any logical blocks written by the Logical Unit to satisfy the writable unit specified by the Blocking field in the Random Readable Feature. This field is 7 for CD-R and DDCD-R media, and may be 0, 1, or 16 for DVD media. Link Size fields are reported by the Logical Unit in the Logical Unit's preferred order, most desirable first.

The Pad field shall contain zeros. The number of Pad bytes shall be $4 * IP((\text{Number of Link Sizes} + 3)/4) - (\text{Number of Link Sizes})$, where $IP()$ is the integer part of the number. The Pad field is present to make the length of the Feature Descriptor a multiple of 4 bytes.

Logical Units that support this Feature shall implement the commands shown in Table 102.

Table 102 – Incremental Streaming Writable Feature Commands

Op Code	Command Description	Reference
A1h	BLANK (Shall be supported if either the Restricted Overwrite Feature or the Rigid Restricted Overwrite Feature is current when this feature is current. If supported, Blanking Types 000b, 001b, and 100b are mandatory for CD-RW and Blanking Types 000b and 001b are mandatory for DVD-RW.)	6.2
5Bh	CLOSE TRACK/SESSION	6.3
51h	READ DISC INFORMATION	6.26
52h	READ TRACK INFORMATION	6.31
53h	RESERVE TRACK	6.35
54h	SEND OPC INFORMATION (Shall be supported if OPC information is ever returned in the READ DISC INFORMATION return data.)	6.41
2Ah	WRITE (10)	6.50
35h	SYNCHRONIZE CACHE	6.47

Logical Units that support this Feature shall implement the mode pages shown in Table 103.

Table 103 – Incremental Streaming Writable Feature Parameters

Page Code	Mode page	Reference
05h	Write Parameters	7.4

5.3.12 Sector Erasable Feature (0022h)

This Feature identifies a Logical Unit that supports erasable media and media that requires an erase pass before overwrite, such as some magneto-optical technologies. This Feature does not apply to media with direct overwrite technology (i.e., CD-RW, DDCD-RW, DVD-RAM, DVD-RW and DVD+RW).

The Feature descriptor response data to be returned to the Initiator is defined in Table 104.

Table 104 – Sector Erasable Feature Descriptor Format

Byte	Bit	7	6	5	4	3	2	1	0
0	(MSB)	Feature Code = 0022h							
1		(LSB)							
2		Reserved		Version			Persistent	Current	
3		Additional Length							

The Feature Code field shall be set to 0022h.

The Version field shall be set to 0h.

The Persistent bit shall be defined as in 5.2.3.

The Current bit shall be defined as in 5.2.4.

The Additional Length field shall be set to 00h.

Logical Units that support this Feature shall implement the commands listed in Table 105.

Table 105 – Sector Erasable Feature Commands

Op Code	Command Description	Reference
2Ch	ERASE(10)	6.4
2Fh	VERIFY (10) (The BLKVfy bit shall be supported.)	6.49
2Ah	WRITE (10) (The EBP bit shall be supported.)	6.50

5.3.13 Formattable Feature (0023h)

This Feature identifies a Logical Unit that is able to format media into logical blocks. The Feature descriptor response data to be returned to the Initiator is defined in Table 106.

Table 106 – Formattable Feature Descriptor Format

Bit	7	6	5	4	3	2	1	0
Byte								
0	(MSB) Feature Code = 0023h							
1	(LSB)							
2	Reserved		Version			Persistent	Current	
3	Additional Length = 00h							

The Feature Code field shall be set to 0023h.

The Version field shall be set to 0h.

The Persistent bit shall be defined as in 5.2.3.

The Current bit shall be defined as in 5.2.4.

The Additional Length field shall be set to zero.

Logical Units that support this Feature shall implement the commands listed in Table 107.

Table 107 – Formattable Feature Commands

Op Code	Command Description	Reference
04h	FORMAT UNIT with a Format Code of 001b	6.5
23h	READ FORMAT CAPACITIES	6.28
03h	REQUEST SENSE	6.34
2Fh	VERIFY (10)	6.49

5.3.14 Hardware Defect Management Feature (0024h)

This Feature identifies a Logical Unit that shall have defect management available to provide a defect-free contiguous address space.

The Feature descriptor response data to be returned to the Initiator is defined in Table 108.

Table 108 – Defect Management Feature Descriptor Format

Byte	Bit	7	6	5	4	3	2	1	0
0	(MSB)	Feature Code = 0024h							
1		(LSB)							
2		Reserved		Version			Persistent	Current	
3		Additional Length = 04h							
4		SSA	Reserved						
5		Reserved							
6		Reserved							
7		Reserved							

The Feature Code field shall be set to 0024h.

The Version Field shall be set to 1h.

The Persistent bit shall be defined as in 5.2.3.

The Current bit shall be defined as in 5.2.4.

The Additional Length field shall be set to 4h.

An SSA bit of one shall indicate that the Logical Unit supports the READ DVD STRUCTURE command with Format Code 0Ah (Spare Area Information).

Logical Units that support this Feature shall implement the commands as specified in Table 109.

Table 109 – Defect Management Feature Commands

Op Code	Command Description	Reference
ADh	READ DVD STRUCTURE, format code 0Ah (mandatory only when SSA is set to one)	6.27

Logical Units that support this Feature shall implement the mode pages listed in Table 110.

Table 110 – Defect Management Feature Mode Pages

Page Code	Mode Page	Reference
01h	Read/Write Error Recovery Parameters (AWRE and ARRE shall be supported if the medium is Writable.)	7.2

5.3.15 Write Once Feature (0025h)

This Feature identifies a Logical Unit that shall have the ability to record to any previously unrecorded logical block. The recording of logical blocks may occur in any order. Previously recorded blocks shall not be overwritten.

The Feature descriptor response data to be returned to the Initiator is defined in Table 111.

Table 111 – Write Once Feature Descriptor Format

Byte	Bit	7	6	5	4	3	2	1	0
0	(MSB)	Feature Code = 00025h							
1		(LSB)							
2		Reserved		Version			Persistent	Current	
3		Additional Length = 08h							
4	(MSB)	Logical Block Size							
5									
6									
7									
8	(MSB)	Blocking							
9									
10		Reserved							PP
11		Reserved							

The Feature Code field shall be set to 25h.

The Version field shall be set to 0h.

The Persistent bit shall be defined as in 5.2.3.

The Current bit shall be defined as in 5.2.4.

The Additional Length field shall be set to 08h.

The Logical Block Size is the number of bytes per logical block. This value shall be the same as reported by the Random Readable Feature and the READ CAPACITY command.

The Blocking field shall indicate the number of logical blocks per Logical Unit writable unit. For most hard disks, this value is 1. For DVD devices, this number is 10h. The Blocking field reported in the Feature Descriptor is for performance optimization only. A write of any sector or sector count shall be allowed.

If there is more than one Blocking on the medium possible, the Blocking field shall be set to zero. See the READ TRACK INFORMATION command for more information.

When the PP (Page Present) bit is set to zero, the Logical Unit does not claim to support the Read/Write Error Recovery Mode Page. When PP is set to one, the Read/Write Error Recovery Mode Page shall be supported.

Logical Units that support this Feature shall implement the commands listed in Table 112.

Table 112 – Write Once Feature Commands

Op Code	Command Description	Reference
25h	READ CAPACITY	6.23
35h	SYNCHRONIZE CACHE	6.47
2Ah	WRITE (10)	6.50
2Eh	WRITE AND VERIFY (10)	6.52

Logical Units that support this Feature shall implement the mode pages as specified in Table 113.

Table 113 – Write Once Feature Mode Pages

Page Code	Mode Page	Reference
01h	MM Read/Write Error Recovery Parameters (Mandatory only when PP is set to one)	7.2

5.3.16 Restricted Overwrite Feature (0026h)

This Feature identifies a Logical Unit that shall have the ability to overwrite logical blocks only in fixed sets at a time.

The Feature descriptor response data to be returned to the Initiator is defined in Table 114.

Table 114 – Restricted Overwrite Feature Descriptor Format

Byte	Bit	7	6	5	4	3	2	1	0	
0	(MSB)	Feature Code = 0026h						(LSB)		
1										
2		Reserved		Version			Persistent	Current		
3		Additional Length = 00h								

The Feature Code field shall be set to 0026h.

The Version field shall be set to 0h.

The Persistent bit shall be defined as in 5.2.3. This bit shall be set to zero if the medium is removable.

The Current bit shall be defined as in 5.2.4. This bit shall be set to zero if Restricted Overwrite medium is not present.

The Additional Length field shall be set to zero.

Logical Units that claim this Feature shall support the commands specified in Table 115.

Table 115 – Restricted Overwrite Feature Commands

Op Code	Command Description	Reference
25h	READ CAPACITY	6.23
51h	READ DISC INFORMATION	6.26
52h	READ TRACK INFORMATION	6.31
35h	SYNCHRONIZE CACHE	6.47
2Ah	WRITE (10)	6.50

Logical Units that claim this Feature shall support the mode pages specified in Table 116.

Table 116 – Restricted Overwrite Feature Mode Pages

Page Code	Mode Page	Reference
05h	Write Parameters	7.4

5.3.17 CD-RW CAV Write Feature (0027h)

This Feature identifies a Logical Unit that has the ability to write CD-RW media that is designed for CAV recording. The Logical Unit shall conform to the Orange Book Part 3 Volume 2 specification. This Feature shall not be current if high-speed recordable CD-RW media is not mounted. Logical Unit with write protected media shall not have this Feature current. Logical Units with installed medium that support this Feature shall implement the commands listed in Table 117.

Table 117 – CD-RW CAV Write Feature Commands

Op Code	Command Description	Reference
25h	READ CAPACITY	6.23
51h	READ DISK INFORMATION	6.26
52h	READ TRACK INFORMATION	6.31
35h	SYNCHRONIZE CACHE	6.47
2Ah	WRITE (10)	6.50

Table 118 – CD-RW CAV Write Feature Parameters

Page Code	Parameter	Reference
05h	Write Parameters Page	7.4

The CD-RW CAV Write Feature descriptor response data to be returned to the Initiator is defined in Table 153.

Table 119 – CD-RW CAV WRITE Feature Descriptor

Byte	Bit	7	6	5	4	3	2	1	0
0	(MSB)	Feature Code = 0027h							
1		(LSB)							
2		Reserved		Version			Persistent	Current	
3		Additional Length = 04h							
4		Reserved							
5		Reserved							
6		Reserved							
7		Reserved							

The Feature Code field shall be set to 0027h.

The Version field shall be set to zero.

The Persistent bit shall be defined as in 5.2.3.

The Current bit shall be defined as in 5.2.4.

The Additional Length field shall be set to 04h.

5.3.18 The MRW Feature (0028h)

The presence of the MRW Feature indicates that the Logical Unit is capable of reading a disc with the MRW format.

Table 120 – MRW Feature Descriptor

Byte	Bit	7	6	5	4	3	2	1	0
0		Feature Code = 0028h							
1									
2		Reserved		Version			Persistent	Current	
3		Additional Length = 4							
4		Reserved						Write	
5		Reserved							
6		Reserved							
7		Reserved							

The Version field shall be set to zero.

The Persistent bit shall be defined as in 5.2.3. Since MRW medium is removable Persistent is set to zero.

The Current bit shall be defined as in 5.2.4.

Consequently, when Current is set to zero, either no disc is mounted or the disc currently mounted is not a MRW disc, and when Current is set to 1, a disc is mounted and it is a MRW disc.

The Additional Length field shall be set to 04h.

If the Write bit is set to zero, then no additional capability is claimed.

If the Write bit is set to one, then the Logical Unit is also capable of formatting discs in the MRW format and is capable of writing discs that have been MRW formatted. When the Write bit is set to one, then the Logical Unit shall include the Removable Disk Profile and list all features required of that profile.

Logical Units that support this feature shall implement the commands listed in Table 121.

Table 121 – MRW Feature Commands

Op Code	Command Description	Reference
25h	READ CAPACITY	6.23
4Ah	GET EVENT STATUS NOTIFICATION	6.7
51h	READ DISK INFORMATION	6.26
28h	READ (10)	6.19
A8h	READ (12)	6.20

Logical Units that support this feature shall implement the mode pages listed in Table 121.

Table 122 – MRW Feature Parameters

Page Code	Parameter	Reference
03h	MRW Mode Page	7.3

Logical Units that support this feature and its write capabilities shall implement the commands listed in Table 123 in addition to the commands listed in Table 121.

Table 123 – MRW Write Feature Commands

Op Code	Command Description	Reference
5Bh	CLOSE TRACK/SESSION	6.3
04h	FORMAT UNIT	6.5
2Ah	WRITE (10)	6.50
2Eh	WRITE AND VERIFY (10)	6.52
2Fh	VERIFY (10)	6.49
23h	READ FORMAT CAPACITIES	6.28

5.3.19 Enhanced Defect Reporting Feature (0029h)

The Enhanced Defect Reporting Feature identifies a logical unit that has the ability to perform media certification and RECOVERED ERROR reporting for Logical unit assisted software defect management. In case of Persistent-DM mode, the READ (12) command with Streaming bit = 1 may be performed without medium certification.

When this Feature is current, Hardware Defect Management Feature shall not be current. This Feature may be current when Restricted Overwrite formatted media or Rigid Restricted Overwrite formatted media is present.

Table 124 – Enhanced Defect Reporting Feature Descriptor

Bit	7	6	5	4	3	2	1	0
Byte								
0	Feature Code = 0029h							
1								
2	Reserved		Version				Persistent	Current
3	Additional Length = 4							
4	Reserved						DRT-DM	
5	Number of DBI cache zones							
6	(MSB)							
7	Number of entries							(LSB)

The Version field shall be set to zero.

The Persistent bit shall be defined as in 5.2.3. This bit shall be set to zero if the medium is removable.

The Current bit shall be defined as in 5.2.4. This bit shall be set to zero if Hardware Defect Management feature is current. This bit is not affected by the EMCDR field and the PER bit settings.

When this Feature is current, Hardware Defect Management Feature shall not be current. This Feature may be current if Restricted Overwrite formatted media or Rigid Restricted Overwrite formatted media is loaded.

The Additional Length field shall be set to 04h.

The Feature Code field shall be set to 0029h.

DRT-DM bit, if set to 1, shall indicate that the logical unit supports DRT-DM mode. If set to 0, shall indicate that the logical unit supports Persistent-DM mode.

Number of DBI cache zones field specifies possible maximum number of regions that logical unit is able to handle DBI cache separately. If this field is set to 0, shall indicate that logical unit supports "Simple DBI memory model" (see 4.6.4.5.2). If this field is set to 1, shall indicate that logical unit supports "Large DBI buffer memory model" (see 4.6.4.5.3). In case of "Small DBI cache memory model" (see 4.6.4.5.4), the Number of DBI cache zones field shall be set to 2 or higher (minimum number of this field is 2). The value of Number of DBI cache zones field may be changed by media type. If the Feature is not current, this field is invalid.

Table 125 – Relation between Number of DBI cache zones and DBI memory model type

DRT-DM	Number of DBI cache zones field value	Number of entries	DBI buffer model type of logical unit
0	0	m (≥ 10)	simple memory model, cleared at the beginning of medium certification
0	1	0	large DBI buffer model
0	2 or higher	m (≥ 10)	small DBI cache model
1	0	N/A	Reserved
1	1	0	large DBI buffer model
1	2 or higher	m (≥ 10)	small DBI cache model

Number of entries filed indicates that the number of entries that in the worst case may cause DBI memory overflow. In case of large DBI buffer model, this field shall be set to zero. For other DBI memory model, this field shall be set to 10 or higher. The value of this field may be changed by media type. If this Feature is not current, this field is invalid.

Logical Units that support this feature shall implement the commands listed in Table 115.

Table 126 – Enhanced Defect Reporting Feature Commands

Op Code	Command Description	Reference
4Ah	GET PERFORMANCE with Type = 4	6.7
28h	READ (10)	6.19
A8h	READ (12) with Streaming bit =0	6.20
51h	READ DISC INFORMATION	6.26
2Ah	WRITE (10)	6.50
AAh	WRITE (12) with Streaming bit =0	6.51
2Fh	VERIFY (10)	6.49
2Eh	WRITE AND VERIFY (10)	6.52
35h	SYNCHRONIZE CACHE with Implicit Sync Cache	6.47

Logical Units that support this feature shall implement the mode pages listed in Table 116.

Table 127 – Enhanced Defect Reporting Feature Parameters

Page Code	Parameter	Reference
01h	PER bit and EMCDR field in Read/Write Error Recovery Parameters Mode Page	7.2

Logical Units that support this feature and have DRT-DM capabilities shall implement the commands listed in Table 117 in addition to the commands listed in Table 115.

Table 128 – Enhanced Defect Reporting DRT-DM Feature Commands

Op Code	Command Description	Reference
A8h	READ (12) with Streaming bit =1	6.20
AAh	WRITE (12) with Streaming bit =1	6.51

Logical Units that support this feature and if small DBI cache memory model is supported, shall implement the commands listed in Table 118 in addition to the commands listed in Table 115.

Table 129 – Enhanced Defect Reporting small DBI cache memory model Feature Commands

Op Code	Command Description	Reference
ACh	GET PERFORMANCE with Type = 4, 5	6.7
B6h	SET STREAMING with Type =5	6.44

5.3.20 DVD+RW Feature (002Ah)

The presence of the DVD+RW Feature indicates that the Logical Unit is capable of reading a recorded DVD+RW disc that is formatted according to *DVD+RW 4,7 Gbytes Basic Format Specifications*. The DVD+RW Feature descriptor is shown in Table 130.

Table 130 – DVD+RW Feature Descriptor

Bit	7	6	5	4	3	2	1	0
0	(MSB) Feature Code = 002Ah							
1	(LSB)							
2	Reserved		Version			Persistent	Current	
3	Additional Length							
4	Reserved						Write	
5	Reserved					Quick Start	Close Only	
6	Reserved							
7	Reserved							

The Version field shall be set to 0h.

The Persistent bit shall be defined as in 5.2.3.

The Current bit shall be defined as in 5.2.4.

The Additional Length field shall be set to 04h.

This feature may be present only to represent additional capability for the DVD-ROM Profile. If the Write bit is set to zero, then no additional capability is claimed. A device may report this feature only when Profile 10h (DVD-ROM) is reported. No additional commands or mode parameters are required.

If the Write bit is set to one, then the Logical Unit is also capable of background formatting DVD+RW discs according to *DVD+RW 4,7 Gbytes Basic Format Specifications* and is capable of writing DVD+RW discs that have been formatted according to *DVD+RW 4,7 Gbytes Basic Format Specifications*.

If the Close Only bit is set to zero, then the Logical Unit supports both forms of background format stop. If the Close Only bit is set to one, then the Logical Unit supports only the read compatibility stop.

If the Quick Start bit is zero, the FORMAT UNIT command does not support quick start formatting. If the Quick Start bit is set to one, the FORMAT UNIT command supports quick start formatting.

If a Logical Unit reports this feature with the Write bit set to one and the Current bit is to one, then it shall support the commands shown in Table 131.

Table 131 – Command Support Required by the DVD+RW Feature with Write = 1

Op Code	Write Bit	Command Description	Reference
5Bh	1	CLOSE TRACK/SESSION	6.3
04h	1	FORMAT UNIT	6.5
ADh	-	READ DVD STRUCTURE (format field values 0, 1, 3, 4, 5, 30h, and FFh)	6.27
43h	-	READ TOC/PMA/ATIP	6.30
BFh	1	SEND DVD STRUCTURE (format field value 05h)	6.39
2Ah	1	WRITE (10)	6.50
AAh	1	WRITE (12)	6.51
2Eh	1	WRITE AND VERIFY (10)	6.52

The DVD+RW Feature does not require the use of the Write Parameters Mode Page. If the Write Parameters Mode Page is supported for other media types, the Logical Unit shall accept valid mode selects to the Write Parameters Mode Page. The Initiator should be aware that the Logical Unit shall ignore the Write Parameters Mode Page when the DVD+RW Feature is current.

5.3.21 DVD+R Feature (002Bh)

The presence of the DVD+R Feature indicates that the Logical Unit is capable of reading a recorded DVD+R disc that is written according to *DVD+R 4,7 Gbytes Basic Format Specifications*. Specifically, this includes the capability of reading DCBs. The DVD+R Feature descriptor is shown in Table 132.

Table 132 – DVD+R Feature Descriptor

Bit	7	6	5	4	3	2	1	0
0	(MSB) Feature Code = 002Bh							
1	(LSB)							
2	Reserved		Version			Persistent	Current	
3	Additional Length							
4	Reserved						Write	
5	Reserved							
6	Reserved							
7	Reserved							

The Version field shall be set to 0h.

The Persistent bit shall be defined as in 5.2.3.

The Current bit shall be defined as in 5.2.4.

Consequently, when Current = 0, either no disc is mounted or the disc currently mounted is not a DVD+R disc, and when Current = 1, a disc is mounted and it is a DVD+R disc.

The Additional Length field shall be set to 04h.

This feature may be present only to represent additional capability to the DVD-ROM Profile. If the Write bit is set to zero, then no additional capability is claimed. A device may report this feature only when Profile 10h (DVD-ROM) is reported. No additional commands or mode parameters are required.

If the Write bit is set to one, then the Logical Unit is also capable of writing DVD+R discs according to *DVD+R 4,7 Gbytes Basic Format Specifications*.

If a Logical Unit reports this feature with the Write bit set to one and the Current bit set to one, then it shall support the commands shown in Table 133.

Table 133 – Command Support Required by the DVD+R Feature with Write = 1

Op Code	Write Bit	Command Description	Reference
5Bh	1	Close Track/Session	6.3
51h	-	Read Disc Information	6.26
ADh	-	READ DVD STRUCTURE (format field values 0, 1, 3, 4, 5, 30h, and FFh)	6.27
43h	-	READ TOC/PMA/ATIP	6.30
52h	-	Read Track I	6.31
53h	1	Reserve Track	6.35
BFh	1	Send DVD Structure (format field value 05h)	6.39
35h	1	Synchronize Cache	6.47
2Ah	1	Write (10)	6.50
AAh	1	Write (12)	6.51

The DVD+R Feature does not require the use of the Write Parameters Mode Page. If the Write Parameters Mode Page is supported for other media types, the Logical Unit shall accept valid mode selects to the Write Parameters Mode Page. The Initiator should be aware that the Logical Unit shall ignore the Write Parameters Mode Page when the DVD+R Feature is current.

5.3.22 Rigid Restricted Overwrite Feature (002Ch)

This Feature identifies a Logical Unit that has the ability to perform writing only on Blocking boundaries. This Feature is different from the Restricted Overwrite Feature (0026h) because each Write command is also required to end on a Blocking boundary. This Feature replaces the Random Writable Feature for Logical Units that do not perform read-modify-write operations on write requests smaller than Blocking. This Feature may be present when DVD-RW Restricted Overwritable media is loaded. Logical Units with write protected media shall not have this Feature current. This Feature shall not be current if the Random Writable Feature is current. If this Feature is current, the Random Writable Feature shall not be current. The Feature descriptor response data is defined in Table 134.

Table 134 – Rigid Restricted Overwrite Feature Descriptor Format

Byte	Bit	7	6	5	4	3	2	1	0
0	(MSB)	Feature Code = 002Ch							
1		(LSB)							
2		Reserved		Version			Persistent	Current	
3		Additional Length = 04h							
4		Reserved			DSDG	DSDR	Inter- mediate	Blank	
5		Reserved							
6		Reserved							
7		Reserved							

The Feature Code field shall be set to 002Ch.

The Version field shall be set to 0h.

The Persistent bit shall be defined as in 5.2.3.

The Current bit shall be defined as in 5.2.4.

The Additional Length field shall be set to 04h.

The Defect Status Data Generate (DSDG) bit, if set to 1, shall indicate that the Logical Unit supports to generate Defect Status data during formatting. A disable certification (DCRT) bit (Table 233) shall be supported. If DSDG is set to 0, the Logical Unit does not support generating of Defect Status Bitmap.

The Defect Status Data Read (DSDR) bit, if set to 1, shall indicate that the Logical Unit supports to read Defect Status data recorded on a medium. A disable certification (DCRT) bit (Table 233) shall be supported. If DSDR is set to 0, the Logical Unit does not support reading of Defect Status data.

The Intermediate bit, if set to 1, shall indicate that the Logical Unit supports writing on an intermediate state Session and quick formatting (Format Type of 15h – Quick Format). If Intermediate is set to 0, the Logical Unit does not support writing on an intermediate state Session and quick formatting.

The Blank bit, if set to 1, shall indicate that the Logical Unit supports BLANK command with Blanking Type 00h and 01h. If Blank is set to 0, the Logical Unit does not support BLANK command.

If more than one Track/Session is present on the media, the Initiator should use the READ DISC INFORMATION and READ TRACK INFORMATION commands to obtain a description of the medium such as Blocking factor.

Writing from the Initiator into the media shall be in units of Blocking. Writing shall begin and shall stop at Blocking boundaries. The writable units may be sent via multiple WRITE (10) commands. If a Write does not begin on a Blocking boundary, the Logical Unit shall return CHECK CONDITION status and set SK/ASC/ASCQ values to ILLEGAL REQUEST/INVALID ADDRESS FOR WRITE. If a Write does not end on a Blocking boundary the Logical Unit shall return CHECK CONDITION status and set SK/ASC/ASCQ values to ILLEGAL REQUEST/INVALID FIELD IN CDB.

Logical Units that support this Feature shall implement the commands identified in Table 135.

Table 135 – Rigid Restricted Overwrite Feature Commands

Op Code	Command Description	Reference
A1h	BLANK with Blanking Type = 00h, 01h (Whenever Blank = 1)	6.2
ACh	GET PERFORMANCE with Type =2 (whenever DSDR = 1)	6.8
51h	READ DISC INFORMATION	6.26
52h	READ TRACK INFORMATION	6.31
25h	READ CAPACITY	6.23
35h	SYNCHRONIZE CACHE	6.47
2Fh	VERIFY (10)	6.49
2Ah	WRITE (10)	6.50

5.3.23 CD Track at Once Feature (002Dh)

This Feature identifies a Logical Unit that is able to write data to a CD track.

The Feature descriptor response data to be returned to the Initiator is defined in Table 136.

Table 136 – CD Track at Once Feature Descriptor Format

Byte	Bit	7	6	5	4	3	2	1	0
0	(MSB)	Feature Code = 002Dh							
1		(LSB)							
2		Reserved		Version = 2h			Persistent	Current	
3		Additional Length = 04h							
4		Resvd	BUF	Resvd	R-W Raw	R-W Pack	Test Write	CD-RW	R-W Sub-code
5		Reserved							
6	(MSB)	Data Type Supported							
7		(LSB)							

The Feature Code field shall be set to 002Dh.

The Version Field shall be set to 2h.

The Persistent bit shall be defined as in 5.2.3.

The Current bit shall be defined as in 5.2.4.

The Additional Length field shall be set to 04h.

The following bits indicate Feature support. When the bit is zero, the Feature is not supported. When the bit is one, the Feature is supported.

The BUF bit, if set to 1, shall indicate that the Logical Unit is capable of zero loss linking.

The R-W Raw bit, if set to 1, shall indicate that the Logical Unit supports writing R-W Sub code in the Raw mode. The R-W Sub-code bit shall be set if this bit is set.

The R-W Pack bit, if set to 1, shall indicate that the Logical Unit supports writing R-W Sub code in the Packed mode. The R-W Sub-code bit shall be set if this bit is set.

The Test Write bit indicates that the Logical Unit is able to perform test writes. See 7.4. The CD-RW bit indicates support for overwriting a Track at Once track with another.

The R-W Sub-code bit indicates that the Logical Unit is able to record the R-W Sub-channels with user supplied data.

The Data Type Supported field is defined in 5.3.11.

Logical Units that support this Feature shall implement the commands and Features identified in Table 137.

Table 137 – CD Track at Once Feature Commands

Op Code	Command Description	Reference
A1h	BLANK (Blanking Type 000b, 001b, and 100b shall be implemented if the currently mounted media is CD-RW.)	6.2
5Bh	CLOSE TRACK/SESSION	6.3
51h	READ DISC INFORMATION	6.26
52h	READ TRACK INFORMATION	6.31
53h	RESERVE TRACK	6.35
54h	SEND OPC INFORMATION (Shall be implemented if OPC Information is returned in the READ DISC INFORMATION returned data.)	6.41
35h	SYNCHRONIZE CACHE	6.47
2Ah	WRITE (10)	6.50

Logical Units that support this Feature shall implement the mode pages identified in Table 138.

Table 138 – CD Track at Once Feature Mode Parameters

Page Code	Mode Page	Reference
05h	Write Parameters	7.4

5.3.24 CD Mastering (Session at Once) Feature (002Eh)

This Feature identifies a Logical Unit that is able to write a CD in Session at Once or Raw mode.

The Feature descriptor response data to be returned to the Initiator is defined in Table 139.

Table 139 – CD Mastering Feature Descriptor

Byte	Bit	7	6	5	4	3	2	1	0
0	(MSB)	Feature Code = 002Eh							
1		(LSB)							
2		Reserved		Version			Persistent	Current	
3		Additional Length = 04h							
4		Resvd	BUF	SAO	Raw MS	Raw	Test Write	CD-RW	R-W
5	(MSB)	Maximum Cue Sheet Length							
6									
7									

The Feature Code field shall be set to 002Eh.

The Version Field shall be set to 1h.

The Persistent bit shall be defined as in 5.2.3.

The Current bit shall be defined as in 5.2.4.

The Additional Length field shall be set to 04h.

The following bits indicate Feature support. If zero, the Feature is not supported. If one, the Feature is supported.

If BUF is zero, the Logical Unit does not claim the ability of zero loss linking. If BUF is one, the Logical Unit is capable of zero loss linking.

If SAO is zero, the Logical Unit does not claim the ability of recording the Session At Once write type.

If SAO is one, the Logical Unit is capable of recording the Session at Once write type.

If Raw MS is zero, the Logical Unit does not claim the ability of recording multi-session in raw mode.

If Raw MS is one, the Logical Unit is capable of recording multi-session in raw mode.

If Raw is zero, the Logical Unit does not claim the ability of recording in the raw write type. If Raw is one, the Logical Unit is capable of recording using the raw write type.

If Test Write is zero, the Logical Unit does not claim the ability to perform Test Writing. If Test Write is one, the Logical Unit is capable of performing Test Writing.

If CD-RW is zero, the Logical Unit does not claim the ability to record and overwrite CD-RW media. If CD-RW is one, the Logical Unit is capable if writing and overwriting on CD-RW media.

If R-W is zero, the Logical Unit does not claim the ability to record R-W sub-channels with user supplied data. If R-W is one, the Logical Unit is capable of recording the R-W Sub-channels with user supplied information.

The Maximum Cue Sheet Length field indicates the maximum length of a Cue Sheet that is possible to be accepted by the Logical Unit for Session at Once recording. If the SAO bit is zero, this field shall be set to zero.

Logical Units that support Session at Once mastering shall implement the commands listed in Table 140.

Table 140 – CD Mastering (Session at Once) Feature Commands

Op Code	Command Description	Reference
51h	READ DISC INFORMATION	6.26
52h	READ TRACK INFORMATION	6.31
5Dh	SEND CUE SHEET	0
54h	SEND OPC INFORMATION (Shall be implemented if OPC Information is returned in the READ DISC INFORMATION returned data.)	6.41
2Ah	WRITE (10)	6.50

Logical Units that support Session at Once mastering shall implement the parameters listed in Table 141.

Table 141 – CD Mastering (Session at Once) Feature Parameter

Page Code	Parameter	Reference
05h	Write Parameters – Session-At-Once Write type shall be supported.	7.4

Logical Units that support mastering in RAW mode shall implement the commands listed in Table 142.

Table 142 – CD Mastering (RAW) Feature Commands

Op-Code	Command	Reference
51h	READ DISC INFORMATION	6.26
52h	READ TRACK INFORMATION	6.31
35h	SYNCHRONIZE CACHE	6.47
2Ah	WRITE (10)	6.50

Logical Units that support mastering in RAW mode shall implement the parameters listed in Table 143.

Table 143 – CD Mastering (RAW) Feature Parameters

Page Code	Parameter	Reference
05h	Write Parameters Page <ul style="list-style-type: none"> • RAW Write Type shall be supported • Data Block Type 2 and 3 shall be supported when R-W bit is set to one. 	7.4

5.3.25 DVD-R/-RW Write Feature (002Fh)

This Feature identifies a Logical Unit that has the ability to write data to DVD-R/-RW in Disc at Once mode. The DVD-R/-RW Write Feature descriptor response data to be returned to the Initiator is defined in Table 144.

Table 144 – DVD-R/-RW Write Feature Descriptor Format

Byte	Bit	7	6	5	4	3	2	1	0
0	(MSB)	Feature Code = 002Fh							
1		(LSB)							
2		Reserved		Version = 1h			Persistent	Current	
3		Additional Length = 04h							
4		Reserved	BUF	Reserved		Test Write	DVD-RW	Reserved	
5		Reserved							
6		Reserved							
7		Reserved							

The Feature Code field shall be set to 002Fh.

The Version Field shall be set to 1h.

The Persistent bit shall be defined as in 5.2.3. This bit shall be set to zero if the medium is removable.

The Current bit shall be defined as in 5.2.4. This bit shall be set to zero if DVD-R/-RW media is not present.

The Additional Length field shall be set to 04h.

The BUF bit, when set to one, indicates the Logical Unit is able to perform Buffer Under-run Free recording.

The Test Write bit, when set to zero, shall indicate that the Logical Unit is not capable of performing test writes. When set to one, the Logical Unit is capable of performing test writes.

The DVD-RW bit indicates support for writing and erasing on DVD-RW media. If this bit set to one, shall indicate that the Logical Unit supports BLANK command, Blanking Type 00h and 01h.

Logical Units that write and read DVD-R/-RW media shall support the commands specified in Table 145.

Table 145 – DVD-R/-RW Write Feature Commands

Op Code	Command Description	Reference
A1h	BLANK with Blanking Type 00h and 01h (Shall be implemented if DVD-RW bit = 1.)	6.2
51h	READ DISC INFORMATION	6.26
52h	READ TRACK INFORMATION	6.31
53h	RESERVE TRACK	6.35
BFh	SEND DVD STRUCTURE (format field values 04h, 05, and 0Fh)	6.39
2Ah	WRITE (10)	6.50

Logical Units that write and read DVD-R/-RW media shall support the parameters identified in Table 146.

Table 146 – DVD-R/-RW Write Feature Parameters

Page Code	Parameter	Sub-Reference
05h	Write Parameter - Session at Once Write Type shall be supported	7.4

5.3.26 Double Density CD Read Feature (0030h)

This Feature identifies a Logical Unit that is able to read DDCD specific information from the media and is able to read user data from DDCD blocks.

The DDCD Read Feature descriptor response data to be returned to the Initiator is defined in Table 147.

Table 147 – DDCD Read Feature Descriptor Format

Bit	7	6	5	4	3	2	1	0	
Byte									
0	(MSB) Feature Code = 0030h								
1								(LSB)	
2	Reserved		Version			Persistent	Current		
3	Additional Length = 00h								

The Feature Code field shall be set to 0030h.

Version shall be set to 0h.

The Persistent bit shall be defined as in 5.2.3.

The Current bit shall be defined as in 5.2.4.

The Additional Length field shall be set to 00h.

A Logical Unit that supports this Feature shall support the commands specified in Table 148.

Table 148 – DDCD Read Feature Commands

Op Code	Command Description	Reference
BEh	READ CD	6.24
43h	READ TOC/PMA/ATIP Supports Format codes 0h, 1h, and 2h.	6.30

5.3.27 Double Density CD-R Write Feature (0031h)

This Feature identifies a Logical Unit that is able to write data to DDCCD-R.

The DDCCD-R Write Feature descriptor response data to be returned to the Initiator is defined in Table 149.

Table 149 – DDCCD-R Write Feature Descriptor Format

Byte	Bit	7	6	5	4	3	2	1	0
0	Feature Code = 0031h								
1	Feature Code = 0031h								
2	Reserved			Version			Persistent	Current	
3	Additional Length = 4								
4	Reserved					TestWR	Reserved		
5	Reserved								
6	Reserved								
7	Reserved								

The Feature Code field shall be set to 0031h.

The Version field shall be set to 0h.

The Persistent bit shall be defined as in 5.2.3.

The Current bit shall be defined as in 5.2.4.

The Additional Length field shall be set to 04h.

The TestWR bit, when set to zero, shall indicate that the Logical Unit is not capable of performing test writes. When set to one, the Logical Unit shall be capable of performing test writes.

A Logical Unit that writes and reads DDCCD-R media shall support the commands specified in Table 150.

Table 150 – DDCCD-R Write Feature Commands

Op Code	Command Description	Reference
51h	READ DISC INFORMATION	6.26
52h	READ TRACK INFORMATION	6.31
53h	RESERVE TRACK	6.35
2Ah	WRITE (10)	6.50
AAh	WRITE (12)	6.51

5.3.28 Double Density CD-RW Write Feature (0032h)

This Feature identifies a Logical Unit that is able to write data to DD CD-RW.

The DD CD-RW Write Feature descriptor response data to be returned to the Initiator is defined in Table 151.

Table 151 – DD CD-RW Write Feature Descriptor Format

Bit	7	6	5	4	3	2	1	0	
Byte									
0	(MSB) Feature Code = 0032h								
1									(LSB)
2	Reserved		Version			Persistent	Current		
3	Additional Length = 4								
4	Reserved					Intermediate	Blank		
5	Reserved								
6	Reserved								
7	Reserved								

The Feature Code field shall be set to 0032h.

The Version field shall be set to 0h.

The Persistent bit shall be defined as in 5.2.3.

The Current bit shall be defined as in 5.2.4.

The Additional Length field shall be set to 04h.

The Intermediate bit, if set to 1, shall indicate that the Logical Unit supports quick formatting (Format Type of 28h – Quick Format). If set to 0, shall indicate that the Logical Unit does not support and quick formatting.

The Blank bit, if set to 1, shall indicate that the Logical Unit supports BLANK command, Blanking Type 00h and 01h. If set to 0, shall indicate that the Logical Unit does not support BLANK command.

Logical Unit that write and read DD CD-RW media shall support the commands specified in Table 152.

Table 152 – DD CD-RW Write Feature Commands

Op Code	Command Description	Reference
51h	READ DISC INFORMATION	6.26
52h	READ TRACK INFORMATION	6.31
53h	RESERVE TRACK	6.35
2Ah	WRITE (10)	6.50
AAh	WRITE (12)	6.51

5.3.29 CD-RW Media Write Support Feature (0037h)

This Feature identifies a Logical Unit that has the ability to perform writing CD-RW media. This Feature shall not be current if CD-RW media is not mounted. The CD-RW Media Write Support Feature descriptor response data to be returned to the Initiator is defined in Table 153.

Table 153 – CD-RW Media Write Support Feature Descriptor

Byte	Bit	7	6	5	4	3	2	1	0
0	(MSB)	Feature Code = 0037h							
1		(LSB)							
2		Reserved		Version			Persistent	Current	
3		Additional Length = 04h							
4		Reserved							
5		CD-RW media sub-type support (when Disc Type = 1)							
		Subtype7	Subtype6	Subtype5	Subtype4	Subtype3	Subtype2	Subtype1	Subtype0
6		Reserved							
7		Reserved							

The Feature Code field shall be set to 0037h.

The Version field shall be set to 0000b.

The Persistent bit shall be defined as in 5.2.3.

The Current bit shall be defined as in 5.2.4.

The Additional Length field shall be set to 04h.

CD-RW media is identified in the media lead-in ATIP when Disc Type = 1. The specific CD-RW media type is identified in the Disc sub-type code, a 3 bit value. Byte 5 identifies the sub-types supported by the Logical Unit. If SubtypeX = 0, then the Logical Unit does not support writing SubtypeX. If SubtypeX = 1, then the Logical Unit supports writing SubtypeX. Refer to System Description ReWritable Compact Disc Systems, part III Volume 2: CD-RW (see 2.4) for details of the specific media identified by Disc Type and Disc Sub-type codes.

No specific command or mode page support is required by the presence of this feature.

5.3.30 Power Management Feature (0100h)

This Feature identifies a Logical Unit that is able to perform Initiator and Logical Unit directed power management.

The Feature descriptor response data to be returned to the Initiator is defined in Table 154.

Table 154 – Power Management Feature Descriptor Format

Bit	7	6	5	4	3	2	1	0
Byte								
0	(MSB) Feature Code = 0100h (LSB)							
1								
2	Reserved		Version			Persistent	Current	
3	Additional Length = 00h							

The Feature Code field shall be set to 0100h.

The Version field shall be set to 0h.

The Persistent bit shall be set to one.

The Current bit shall be set to one.

The Additional Length field shall be set to zero.

Logical Units that support this Feature shall implement the commands specified in Table 155 and the mode parameters specified in Table 156.

Table 155 – Power Management Feature Commands

Op Code	Command Description	Reference
4Ah	GET EVENT STATUS NOTIFICATION (Power Management Class events shall be supported)	6.7
1Bh	START STOP UNIT (Power Condition field shall be supported)	6.45

Table 156 – Power Management Feature Parameters

Page Code	Page Description	Reference
1Ah	Power Condition mode page	7.7

5.3.31 S.M.A.R.T. Feature (0101h)

This Feature identifies a Logical Unit that is able to perform Self-Monitoring Analysis and Reporting Technology. S.M.A.R.T. was developed to manage the reliability of data storage Logical Units. S.M.A.R.T.

Peripheral data storage Logical Units may suffer performance degradation or failure due to a single event or a combination of events. Some events are immediate and catastrophic while others cause a gradual degradation of the Logical Unit's ability to perform. It is possible to predict a portion of the failures, but S.M.A.R.T. is unable to and shall not predict all future Logical Unit failures.

It is the responsibility of a S.M.A.R.T. Logical Unit to predict an impending failure and report that failure via an Informational Exception Condition.

Byte	Bit	7	6	5	4	3	2	1	0
0	(MSB)	Feature Code = 0101h							
1		(LSB)							
2		Reserved		Version			Persistent	Current	
3		Additional Length = 04h							
4		Reserved						PP	
5		Reserved							
6		Reserved							
7		Reserved							

The Feature Code field shall be set to 0101h.

The Version field shall be set to 0h.

The Persistent bit shall be defined as in 5.2.3.

The Current bit shall be defined as in 5.2.4.

The Additional Length field shall be set to 04h.

If the Page Present (PP) bit is set to zero, then this Logical Unit claims no support for the Informational Exceptions Control mode page (1Ch).

If the Page Present (PP) bit is set to one, then the this Logical Unit supports the Informational Exceptions Control mode page (1Ch).

If the Fault / Failure Reporting Mode Page is not supported the Logical Unit shall use the following default values:

1. Performance (Perf) bit shall be 0 (Delays are acceptable).
2. Enable Warning (Ewasc) bit shall be 0 (Disable WARNING Sense Code reporting).
3. Disable Exception Control (Dexcept) bit shall be 0 (Do not Disable reporting of exception conditions). Test bit shall be 0.
4. Method of Reporting Informational Exceptions (MRIE) shall be 4 (Unconditionally generate recovered error).
5. Interval Timer shall be set to 6 000.

5.3.32 Embedded Changer Feature (0102h)

This Feature identifies a Logical Unit that is able to move media from a storage area to a mechanism and back.

The Feature descriptor response data to be returned to the Initiator is defined in Table 157.

Table 157 – Embedded Changer Feature Descriptor Format

Byte	Bit	7	6	5	4	3	2	1	0
0	(MSB)	Feature Code = 0102h							
1		(LSB)							
2		Reserved		Version			Persistent	Current	
3		Additional Length = 04h							
4		Reserved		SCC	Reserved	SDP	Reserved		
5		Reserved							
6		Reserved							
7		Reserved			Highest Slot Number				

The Feature Code field shall be set to 0102h.

The Version field shall be set to 0h.

The Persistent bit shall be defined as in 5.2.3.

The Current bit shall be defined as in 5.2.4.

The Additional Length field shall be set to 4.

The SCC (Side Change Capable) bit, when set to zero, shall indicate that the Logical Unit is not capable of selecting both sides of the media. When set to one, shall indicate that the Logical Unit is capable of selecting both sides of the media.

The SDP (Supports Disc Present) bit, when set to zero, shall indicate that the Logical Unit is unable to report the contents of the slots after a reset or magazine change. When set to one, shall indicate that the Logical Unit is able to report the contents of the slots after a reset or magazine change and that the response to the MECHANISM STATUS command shall contain valid Disc is Present status information for all slots.

Highest Slot Number shall be set to the number of slots minus one.

If this Feature is current, the Removable Medium Feature shall be current. Logical Units that support an embedded changer shall implement the commands specified in Table 158.

Table 158 – Embedded Changer Feature Command

Op Code	Command Description	Reference
A6h	LOAD/UNLOAD MEDIUM	6.10
BDh	MECHANISM STATUS (If Logical Unit supports Write Protect Feature (0004h), the Media Cartridge Write Protection status bits (CWP_V, CWP) of the MECHANISM STATUS command shall be supported.)	6.11

5.3.33 CD Audio External Play Feature (0103h)

This Feature identifies a Logical Unit that is able to play CD Audio data directly to an external output. The Feature descriptor response data to be returned to the Initiator is defined in Table 159.

Table 159 – CD Audio External Play Feature Descriptor Format

Byte	Bit	7	6	5	4	3	2	1	0
0	(MSB)	Feature Code = 0103h							
1		(LSB)							
2		Reserved		Version			Persistent	Current	
3		Additional Length = 04h							
4		Reserved				Scan	SCM	SV	
5		Reserved							
6	(MSB)	Number of Volume Levels							
7		(LSB)							

The Feature Code field shall be set to 0103h.

The Version field shall be set to 0h.

The Persistent bit shall be defined as in 5.2.3.

The Current bit shall be defined as in 5.2.4.

The Additional Length field shall be set to 4.

The Scan bit, when set to one, indicates the SCAN command is supported.

If SCM (Separate Channel Mute) is set to zero, all audio channels are muted simultaneously.

If SCM is set to one, it is possible to mute each audio channel independently.

The SV (Separate Volume) bit, when set to zero, shall indicate that all audio channels have the same volume level. When set to one, shall indicate that audio channel volume may be set independently.

The Number of Volume Levels shall indicate the number of discrete volume levels supported by the Logical Unit. If the Logical Unit supports only turning audio on and off, the Number of Volume Levels field shall be set to 2.

Logical Units that have a CD-Audio external output shall support the commands specified by Table 160 and the mode pages specified in Table 161.

A Logical Unit without a CD-Audio output shall respond to a PLAY AUDIO command, that has a transfer length of zero, with CHECK CONDITION status, and set the sense key to ILLEGAL REQUEST. This behavior allows an Initiator to determine if a CD-Audio analog output is supported.

Table 160 – CD-Audio External Play Feature Commands

OpCode	Command Description	Reference
BDh	MECHANISM STATUS	6.11
45h	PLAY AUDIO (10)	6.15
47h	PLAY AUDIO MSF	6.17
43h	READ TOC/PMA/ATIP (format = 0h)	6.30
42h	READ SUBCHANNEL	6.29
2Bh	SEEK	6.37
4Eh	STOP PLAY/SCAN	6.46

Table 161 – CD-Audio External Play Feature Parameters

Page Code	Page Description	Reference
0Eh	CD Audio Control Page	7.5

5.3.34 Microcode Upgrade Feature (0104h)

This Feature identifies a Logical Unit that is able to upgrade its internal microcode via the interface. Logical Units that support microcode upgrades shall implement the commands specified in Table 162.

Table 162 – Microcode Upgrade Feature Command

Op Code	Command Description	Reference
3Ch	READ BUFFER with Mode 011b set	6.21
3Bh	WRITE BUFFER with Mode 111b (Download microcode with offset and save)	6.53

The Feature descriptor response data to be returned to the Initiator is defined in Table 163.

Table 163 – Microcode Upgrade Feature Descriptor Format

Byte	Bit	7	6	5	4	3	2	1	0
0	(MSB)	Feature Code = 0104h							
1		(LSB)							
2		Reserved			Version			Persistent	Current
3		Additional Length = 00h							

The Feature Code field shall be set to 0104h.

The Version field shall be set to 0h.

The Persistent bit shall be defined as in 5.2.3.

The Current bit shall be defined as in 5.2.4.

The Additional Length field shall be set to zero.

5.3.35 Timeout Feature (0105h)

This Feature identifies a Logical Unit that is able to always respond to commands within a set time period. If a command is unable to complete normally within the allotted time, it completes with an error.

The Feature descriptor response data to be returned to the Initiator is defined in Table 164.

Table 164 – Timeout Feature Descriptor Format

Bit	7	6	5	4	3	2	1	0
Byte								
0	(MSB) Feature Code = 0105h (LSB)							
1								
2	Reserved		Version = 1			Persistent	Current	
3	Additional Length = 04h							
4	Reserved						Group 3	
5	Reserved							
6	(MSB) Unit Length (LSB)							
7								

The Feature Code field shall be set to 0105h.

The Version field shall be set to 1h.

The Persistent bit shall be defined as in 5.2.3.

The Current bit shall be defined as in 5.2.4.

The Additional Length field shall be set to 04h.

The Group3 bit of one indicates that the logical unit supports the G3Enable bit and the Group3 Timeout field in Timeout & Protect Mode Page (1Dh). If this bit is set to 1, the Logical Unit shall also support VERIFY (10) command and handling of G3tout bit in VERIFY (10) command. See 11.1.1, “Group 3 timeout for Real Time Stream recording/playback” on page 217. If Real-Time Streaming Feature (0107h) is not supported, this bit shall be set to zero.

The Unit Length field indicates a unit of block length, in sectors, corresponds to increase a unit of Group 3 time unit. When the Group3 bit is set to 0, Unit Length field is not valid.

Logical Units that support this Feature shall support the parameters listed in Table 165.

Table 165 – Timeout Feature Parameter

Page Code	Parameter	Reference
1Dh	Timeout and Protect Page	7.9

Logical Units that support queuing shall support Event Notification Class 6. If queuing is not supported, the current command shall be terminated with CHECK CONDITION status and SK/ASC/ASCQ values shall be set to ILLEGAL REQUEST/INSUFFICIENT TIME FOR OPERATION. Event Notification Class 6 (Device Busy) shall be supported if queuing is supported.

5.3.36 DVD CSS Feature (0106h)

This Feature identifies a Logical Unit that is able to perform DVD CSS/CPPM authentication and key management. This Feature identifies Logical Units that support CSS for DVD-Video and CPPM for DVD-Audio. The Logical Unit shall maintain the integrity of the keys by only using DVD CSS authentication and key management procedures. This Feature shall be current only if a media containing CSS-protected DVD-Video and/or CPPM-protected DVD-Audio content is loaded.

The Feature descriptor response data to be returned to the Initiator is defined in Table 166.

Table 166 – DVD CSS Feature Descriptor Format

Byte	Bit	7	6	5	4	3	2	1	0
0	(MSB)	Feature Code 0106h							
1		(LSB)							
2		Reserved		Version			Persistent	Current	
3		Additional Length = 04h							
4		Reserved							
5		Reserved							
6		Reserved							
7		CSS Version							

The Feature Code field shall be set to 0106h.

The Version field shall be set to 0h.

The Persistent bit shall be defined as in 5.2.3.

The Current bit shall be set to zero if DVD CSS/CPPM media is not present. Otherwise, this bit shall be defined as in 5.2.4.

The Additional Length field shall be set to 4.

The CSS version shall be set to 01h.

Logical Units that support this Feature shall implement the commands specified by Table 167.

Table 167 – DVD CSS Feature Commands

Op Code	Command Description	Reference
A4h	REPORT KEY except KEY Format 010001b (Note)	6.33
A3h	SEND KEY	6.40
ADh	READ DVD STRUCTURE with Format Code 02h	6.27
NOTE 1: The KEY Format 000100b (TITLE KEY) does not succeed for CPPM protected sectors, since they do not contain a Title Key.		

5.3.37 Real Time Streaming Feature (0107h)

This Feature identifies a Logical Unit that is able to perform reading and writing within Initiator specified (and Logical Unit verified) performance ranges. This Feature also indicates whether the Logical Unit supports the Stream playback operation.

The Feature descriptor response data to be returned to the Initiator is defined in Table 168.

Table 168 – Real Time Streaming Feature Descriptor Format

Byte	Bit	7	6	5	4	3	2	1	0
0	(MSB)	Feature Code = 0107h							
1		(LSB)							
2		Reserved		Version				Persistent	Current
3		Additional Length =04h							
4		Reserved		RBCB	SCS	MP2A	WSPD	SW	
5		Reserved							
6		Reserved							
7		Reserved							

The Feature Code field shall be set to 0107h.

The Version Field shall be set to 3h.

The Persistent bit shall be defined as in 5.2.3.

The Current bit shall be defined as in 5.2.4.

The Additional Length field shall be set to 04h.

The Read Buffer Capacity Block (RBCB) bit indicates that the Logical Unit supports the READ BUFFER CAPACITY command and its Block bit.

The Set CD Speed (SCS) bit of one indicates that the Logical Unit supports the SET CD SPEED command. Otherwise, the Logical Unit does not support the SET CD SPEED command.

The Mode Page 2A (MP2A) bit of one indicates that the MM Capabilities & Mechanical Status Mode Page (2Ah) with the Logical Unit Write Speed Performance Descriptor Blocks is supported.

Otherwise, the MM Capabilities & Mechanical Status Mode Page (2Ah), with the Logical Unit Write Speed Performance Descriptor Blocks are not supported by the Logical Unit.

NOTE 11: The MM Capabilities & Mechanical Status Mode Page is a legacy structure. Implementation is not recommended.

A Write Speed Performance Descriptor (WSPD) bit of one indicates that the Logical Unit supports the Write Speed (Type field = 03h) data of GET PERFORMANCE command and the WRC field of SET STREAMING command. This bit shall be set to one, if Logical Unit supports writing speed selection.

A Stream Writing (SW) bit of one indicates that the Logical Unit supports the Stream recording operation. A SW bit of zero indicates that the Logical Unit may not support the Stream recording operation (see 4.7.4)

Logical Units that support this Feature shall implement the commands listed in Table 169.

Table 169 – Real Time Streaming Feature Commands

Op Code	Command Description	Reference
ACh	GET PERFORMANCE with Type field of 00h, and Type field 01h when SW bit is set to one and Type field of 03h when WSPD bit is set to one	6.8
A8h	READ (12)	6.20
5Ch	READ BUFFER CAPACITY with Block bit of 1 (Shall be implemented if RBCB set to 1)	6.22
B6h	SET STREAMING (WRC field of SET STREAMING command shall be supported if WSPD bit is set to one.)	6.44
A7h	SET READ AHEAD	6.43
AAh	WRITE (12) with Streaming bit when SW bit is set to one	6.51

5.3.38 Logical Unit Serial Number Feature (0108h)

This Feature identifies a Logical Unit that has a unique serial number. The vendor ID, model ID, and serial number is able to uniquely identify a Logical Unit that has this feature.

Table 170 – Logical Unit Serial Number Feature Descriptor

Byte	Bit	7	6	5	4	3	2	1	0
0	(MSB)	Feature Code = 0108h							
1		(LSB)							
2		Reserved		Version				Persistent	Current
3		Additional Length							
4 – n		Serial Number							

The Feature Code field shall be set to 0108h.

The Version Field shall be set to 0h.

The Persistent bit shall be set to one.

The Current bit shall be set to one.

The Additional Length field shall be set to a multiple of 4.

The Serial Number shall be ASCII graphic codes (i.e., codes 20h – 7Eh). Any unused bytes in the Serial Number shall be padded with spaces (20h). There should not be more than three pad bytes.

5.3.39 Media Serial Number Feature (0109h)

This Feature identifies a Logical Unit that is capable of reading a media serial number of the currently installed media.

Table 171 – Logical Unit Serial Number Feature Descriptor

Byte	Bit	7	6	5	4	3	2	1	0
0	(MSB)	Feature Code = 0109h							
1		(LSB)							
2		Reserved		Version			Persistent	Current	
3		Additional Length							

The Feature Code field shall be set to 0109h.

The Version Field shall be set to 0h.

The Persistent bit shall be defined as in 5.2.3.

The Current bit shall be defined as in 5.2.4.

The Additional Length field shall be set to 00h.

A Logical Unit reporting this feature shall implement the commands listed in Table 172.

Table 172 – Commands Required by the Media Serial Number Feature

Op Code	Command Description	Reference
ABh/01h	Read Media Serial Number	SPC-3
NOTE 1: The SERVICE ACTION IN command (ABh) is a meta-command with Service Action Codes that further define specific commands. The READ MEDIA SERIAL NUMBER command is defined by Service Action Code = 01H.		

5.3.40 Disc Control Blocks Feature (010Ah)

This Feature identifies a Logical Unit that is able to read and/or write Disc Control Blocks from or to the media.

Table 173 – Disc Control Blocks Feature Descriptor

Byte	Bit	7	6	5	4	3	2	1	0
0	(MSB)	Feature Code = 010Ah							
1		(LSB)							
2		Reserved		Version			Persistent	Current	
3		Additional Length							
4	(MSB)	Supported DCB entry 0							
5									
6									
7									
n*4 + 4	(MSB)	Supported DCB entry n							
n*4 + 5									
n*4 + 6									
n*4 + 7									

The Feature Code field shall be set to 010Ah.

The Version Field shall be set to 0h.

The Persistent bit shall be defined as in 5.2.3.

The Current bit shall be defined as in 5.2.4.

The Additional Length field shall be set to $N * 4$, where n is the number of Supported DCB entries.

The Supported DCB entry n fields shall each contain the Content Descriptor of a supported DCB.

Entries shall be sorted in ascending order.

Logical Units that support this Feature shall implement the commands listed in Table 174.

Table 174 – Disc Control Blocks Feature Commands

Op Code	Command Description	Reference
ADh	READ DVD STRUCTURE Format Code 30h shall be supported.	6.27
BFh	SEND DVD STRUCTURE (If any DCB's are identified as writable, format code = 30h of this command shall be supported.)	6.39

5.3.41 DVD CPRM Feature (010Bh)

This Feature identifies a Logical Unit that is able to perform DVD CPRM and is able to perform CPRM authentication and key management. This Feature shall be current only if a DVD CPRM recordable or rewritable medium is loaded.

The Feature descriptor response data to be returned to the Initiator is defined in Table 175.

Table 175 – DVD CPRM Feature Descriptor Format

Byte	Bit	7	6	5	4	3	2	1	0
0	(MSB)	Feature Code = 010Bh							
1		(LSB)							
2		Reserved		Version			Persistent	Current	
3		Additional Length = 04h							
4		Reserved							
5		Reserved							
6		Reserved							
7		CPRM version							

The Feature Code field shall be set to 010Bh.

The Version Field shall be set to zero (0h).

The Persistent bit shall be defined as in 5.2.3.

The Current bit shall be defined as in 5.2.4.

The Additional Length field shall be set 04h.

The CPRM version field shall be set to 01h.

Logical Units that support this Feature shall implement the commands listed in Table 176.

Table 176 – DVD CPRM Feature Commands

Op Code	Command Description	Reference
A2h	REPORT KEY (Key formats 000001b, 000010b, 010001b, 111111b)	6.33
A3h	SEND KEY (Key formats 000001b, 000011b, 111111b)	6.40
ADh	READ DVD STRUCTURE (Format codes 06h, 07h)	6.27

5.3.42 Firmware Information Feature (010Ch)

This Feature shall indicate that the Logical Unit provides the date and time of the creation of the current firmware revision loaded on the device. The date and time shall be the date and time of creation of the firmware version. The date and time shall be GMT. The date and time shall not change for a given firmware revision. The date and time shall be later on “newer” firmware for a given device. This Feature shall be persistent and current if present. No commands are required for this Feature.

Table 177 – Firmware Information

Bit	7	6	5	4	3	2	1	0
0	(MSB) Feature Code = 010Ch							
1	(LSB)							
2	Reserved		Version			Persistent	Current	
3	Additional Length = 10h							
4	(MSB) Century							
5	(LSB)							
6	(MSB) Year							
7	(LSB)							
8	(MSB) Month							
9	(LSB)							
10	(MSB) Day							
11	(LSB)							
12	(MSB) Hour							
13	(LSB)							
14	(MSB) Minute							
15	(LSB)							
16	(MSB) Second							
17	(LSB)							
18	Reserved							
19								

The Feature Code field shall be set to 010Ch.

The Version Field shall be set to zero (0h).

The Persistent bit shall be set to one.

The Current bit shall be set to one.

The Additional Length field shall be set to 10h.

When the creation year is represented as 4 decimal digits, the Century field shall contain the two high order decimal digits represented as ASCII (e.g. If the creation year is 2013, the Century field shall contain 3230h).

When the creation year is represented as 4 decimal digits, the Year field shall contain the two low order decimal digits represented as ASCII (e.g. If the creation year is 2013, the Year field shall contain 3133h).

The Month field contains the creation month represented as decimal ASCII (e.g. If the creation month is August, the Month field shall contain 3038h).

The Day field contains the creation day represented as decimal ASCII (e.g. If the creation day is August 12, the Day field shall contain 3132h).

The Hour field contains the creation hour represented as decimal ASCII (e.g. If the creation time is 1:20:43 PM, the Hour field shall contain 3133h).

The Minute field contains the creation minute represented as decimal ASCII (e.g. If the creation time is 1:20:43 PM, the Minute field shall contain 3230h).

The Second field contains the creation second represented as decimal ASCII (e.g. If the creation time is 1:20:43 PM, the Seconds field shall contain 3433h).

5.4 Profile Definitions

5.4.1 Overview

Profiles define a base set of functions for Logical Units. A Logical Unit that specifies a Profile as current shall support all Features required by that Profile, but not all Features may be current. If the Logical Unit is not ready (i.e., a Not Ready response to a TEST UNIT READY command) no Profile shall be current (e.g., a Logical Unit, with unformatted media, may not be able to read or write and the corresponding Features are not current). However, the Profile corresponding to the Logical Unit/media system may be current, (i.e., a DVD-RAM Logical Unit with unformatted media loaded may claim compliance to the DVD-RAM Profile, while a DVD-RAM Logical Unit with no media loaded shall claim no Profile as current.)

Logical Units may support Features in addition to those required by the Profile. A single device may implement more than one Profile, and more than one Profile may be current at any given time. Table 78 shows the list of profiles defined in this document.

5.4.2 Profile 0000h: No Current Profile

The Feature Header (Table 73) contains the Current Profile field. When no supported profile is current, the Current Profile field shall be zero. Consequently, no profile shall be defined for profile number 0000h.

5.4.3 Profile 0001h: Non-Removable Disk

Logical Units identifying Profile 0001h as current shall support the Features listed in Table 178.

Table 178 – Mandatory Features for Non-removable Disks

Feature Number	Feature Name	Description
0000h	Profile List	A list of all Profiles supported by the device
0001h	Core	Basic Functionality
0010h	Random Readable, PP=1	Read ability for storage devices with random addressing.
0020h	Random Writable	Write support for randomly addressed writes
0024h	Defect Management	Ability of the Logical Unit/media system to provide an apparently defect-free space
0100h	Power Management	Initiator and device directed power management
0101h	SMART	Self Monitoring Analysis and Reporting Technology (Failure prediction)

Table 179 shows the decomposition of the profile into features and features into commands and mode pages.

Table 179 – Non-Removable Disk Profile Decomposition

Features	Commands and Mode Pages
Core Feature	GET CONFIGURATION command, GET EVENT STATUS NOTIFICATION command, INQUIRY command, MODE SELECT (10) command, MODE SENSE (10) command, REQUEST SENSE command, TEST UNIT READY command
Random Readable Feature	READ CAPACITY command, READ (10) command, Read/Write Error Recovery Mode Page
Random Writable Feature	READ CAPACITY command, WRITE (10) command, WRITE AND VERIFY (10) command, SYNCHRONIZE CACHE command
Defect Management Feature	Read/Write Error Recovery Mode Page
Power Management Feature	Power Condition mode page
SMART Feature	Fault / Failure Reporting Mode Page ¹

¹The command or mode page is conditional according to the feature description.

5.4.4 Profile 0002h: Removable Disk

Logical Units identifying Profile 0002h as current shall support the Features listed in Table 180.

Table 180 – Mandatory Features for Removable Disks

Feature Number	Feature Name	Description
0000h	Profile List	A list of all Profiles supported by the device
0001h	Core	Basic Functionality
0002h	Morphing	The device changes its operational behavior due to external events
0003h	Removable Medium	The medium may be removed from the device
0010h	Random Readable, PP=1	Read ability for storage devices with random addressing.
0020h	Random Writable	Write support for randomly addressed writes
0023h	Formattable	Support for formatting of media
0024h	Defect Management	Ability of the Logical Unit/media system to provide an apparently defect-free space
0100h	Power Management	Initiator and device directed power management
0105h	Timeout	Ability to respond to all commands within a specific time

Table 181 shows the decomposition of the profile into features and features into commands and mode pages.

Table 181 – Removable Disk Profile Decomposition

Features	Commands and Mode Pages
Core Feature	GET CONFIGURATION command, GET EVENT STATUS NOTIFICATION command, INQUIRY command, MODE SELECT (10) command, MODE SENSE (10) command, REQUEST SENSE command, TEST UNIT READY command
Morphing Feature	GET CONFIGURATION command, GET EVENT STATUS NOTIFICATION command, PREVENT ALLOW MEDIUM REMOVAL command, SEND EVENT command
Removable Medium Feature	MECHANISM STATUS command, PREVENT ALLOW MEDIUM REMOVAL command, START STOP UNIT command
Random Readable Feature	READ CAPACITY command, READ (10) command, Read/Write Error Recovery Mode Page
Random Writable Feature	READ CAPACITY command, WRITE (10) command, WRITE AND VERIFY (10) command, SYNCHRONIZE CACHE command
Formattable Feature	FORMAT UNIT command, READ FORMATTABLE CAPACITIES command, REQUEST SENSE command, VERIFY (10) command
Defect Management Feature	Read/Write Error Recovery Mode Page
Power Management Feature	GET EVENT STATUS NOTIFICATION command, START STOP UNIT command, Power Condition Mode Page
Timeout Feature	Timeout and Protect Mode Page

5.4.5 Profile 0003h: Magneto-Optical Erasable

Logical Units identifying Profile 0003h as current shall support the Features listed in Table 182.

Table 182 – Mandatory Features for Magneto-Optical Erasable

Feature Number	Feature Name	Description
0000h	Profile List	A list of all Profiles supported by the device
0001h	Core	Basic Functionality
0002h	Morphing	The device changes its operational behavior due to external events
0003h	Removable Medium	The medium may be removed from the device
0010h	Random Readable, PP = 1	Read ability for storage with random addressing
0020h	Random Writable	Write support for randomly addressed writes
0022h	Sector Erasable	Write support for erasable media and media that require an erase pass before overwrite.
0023h	Formattable	Support for formatting of media
0024h	Defect Management	Ability of the Logical Unit/media system to provide an apparently defect free space.
0100h	Power Management	Initiator and Logical Unit power management
0105h	Timeout	Ability to response to all commands within a specific time

Table 183 shows the decomposition of the profile into features and features into commands and mode pages.

Table 183 – Magneto-Optical Erasable Profile Decomposition

Features	Commands and Mode Pages
Core Feature	GET CONFIGURATION command, GET EVENT STATUS NOTIFICATION command, INQUIRY command, MODE SELECT (10) command, MODE SENSE (10) command, REQUEST SENSE command, TEST UNIT READY command
Morphing Feature	GET CONFIGURATION command, GET EVENT STATUS NOTIFICATION command, PREVENT ALLOW MEDIUM REMOVAL command, SEND EVENT command
Removable Medium Feature	MECHANISM STATUS command, PREVENT ALLOW MEDIUM REMOVAL command, START STOP UNIT command
Random Readable Feature	READ CAPACITY command, READ (10) command, Read/Write Error Recovery Mode Page
Random Writable Feature	READ CAPACITY command, WRITE (10) command, WRITE AND VERIFY (10) command, SYNCHRONIZE CACHE command
Sector Erasable Feature	ERASE (10) command, VERIFY (10) command
Formattable Feature	FORMAT UNIT command, READ FORMATTABLE CAPACITIES command, REQUEST SENSE command, VERIFY (10) command
Defect Management Feature	Read/Write Error Recovery Mode Page
Power Management Feature	GET EVENT STATUS NOTIFICATION command, START STOP UNIT command, Power Condition Mode Page
Timeout Feature	Timeout and Protect Mode Page

5.4.6 Profile 0004h: Optical Write Once

Logical Units identifying Profile 0004h as current shall support the Features listed in Table 184:

Table 184 – Mandatory Features for Optical Write Once

Feature Number	Feature Name	Description
0000h	Profile List	A list of all Profiles supported by the device
0001h	Core	Basic Functionality
0002h	Morphing	The device changes its operational behavior due to external events
0003h	Removable Medium	The medium may be removed from the device
0010h	Random Readable, PP = 1	Read ability for storage with random addressing
0024h	Defect Management	Ability of the Logical Unit/media system to provide an apparently defect free space.
0025h	Write Once	Write support for write-once media that is writable in random order.
0100h	Power Management	Initiator and Logical Unit power management
0105h	Timeout	Ability to response to all commands within a specific time

Table 185 shows the decomposition of the profile into features and features into commands and mode pages.

Table 185 – Optical Write Once Profile Decomposition

Features	Commands and Mode Pages
Core Feature	GET CONFIGURATION command, GET EVENT STATUS NOTIFICATION command, INQUIRY command, MODE SELECT (10) command, MODE SENSE (10) command, REQUEST SENSE command, TEST UNIT READY command
Morphing Feature	GET CONFIGURATION command, GET EVENT STATUS NOTIFICATION command, PREVENT ALLOW MEDIUM REMOVAL command, SEND EVENT command
Removable Medium Feature	MECHANISM STATUS command, PREVENT ALLOW MEDIUM REMOVAL command, START STOP UNIT command
Random Readable Feature	READ CAPACITY command, READ (10) command, Read/Write Error Recovery Mode Page
Defect Management Feature	Read/Write Error Recovery Mode Page
Write Once Feature	READ CAPACITY command, SYNCHRONIZE CACHE command, WRITE (10) command, WRITE AND VERIFY (10) command Read/Write Error Recovery Mode Page
Power Management Feature	GET EVENT STATUS NOTIFICATION command, START STOP UNIT command, Power Condition Mode Page
Timeout Feature	Timeout and Protect Mode Page

5.4.7 Profile 0005h: AS-MO

Logical Units identifying Profile 0005h shall support the Features listed in Table 186.

Table 186 – Mandatory Features for AS-MO

Feature Number	Feature Name	Description
0000h	Profile List	A list of all Profiles supported by the device
0001h	Core	Basic Functionality
0002h	Morphing	The device changes its operational behavior due to external events
0003h	Removable Medium	The medium may be removed from the device
0010h	Random Readable, PP=1	Read ability for storage devices with random addressing.
0020h	Random Writable	Write support for randomly addressed writes
0023h	Formattable	Support for formatting of media
0024h	Defect Management	Ability of the Logical Unit/media system to provide an apparently defect-free space
0100h	Power Management	Initiator and device directed power management
0105h	Timeout	Ability to respond to all commands within a specific time
0107h	Real-Time Streaming	Ability to read and write using Initiator requested performance parameters

Table 187 shows the decomposition of the profile into features and features into commands and mode pages.

Table 187 – AS-MO Profile Decomposition

Feature	Commands and Mode Pages
Core Feature	GET CONFIGURATION command, GET EVENT STATUS NOTIFICATION command, INQUIRY command, MODE SELECT (10) command, MODE SENSE (10) command, REQUEST SENSE command, TEST UNIT READY command
Morphing Feature	GET CONFIGURATION command, GET EVENT STATUS NOTIFICATION command, PREVENT ALLOW MEDIUM REMOVAL command, SEND EVENT command
Removable Medium Feature	MECHANISM STATUS command, PREVENT ALLOW MEDIUM REMOVAL command, START STOP UNIT command
Random Readable Feature	READ CAPACITY command, READ (10) command, Read/Write Error Recovery Mode Page
Random Writable Feature	READ CAPACITY command, WRITE (10) command, WRITE AND VERIFY (10) command, SYNCHRONIZE CACHE command
Formattable Feature	FORMAT UNIT command, READ FORMATTABLE CAPACITIES command, REQUEST SENSE command, VERIFY (10) command
Defect Management Feature	READ DVD STRUCTURE command ¹ Read/Write Error Recovery Mode Page
Power Management Feature	GET EVENT STATUS NOTIFICATION command, START STOP UNIT command, Power Condition Mode Page
Timeout Feature	Timeout and Protect Mode Page

¹The command or mode page is conditional according to the feature description.

5.4.8 Profile 0008h: CD-ROM

Logical Units identifying Profile 0008h as current shall support the Features listed in Table 188.

Table 188 – Mandatory Features for CD-ROM

Feature Number	Feature Name	Description
0000h	Profile List	A list of all Profiles supported by the device
0001h	Core	Basic Functionality
0002h	Morphing	The device changes its operational behavior due to external events
0003h	Removable Medium	The medium may be removed from the device
0010h	Random Readable, PP=1	Read ability for storage devices with random addressing.
001Eh	CD Read	The ability to read CD specific structures
0100h	Power Management	Initiator and device directed power management
0105h	Timeout	Ability to respond to all commands within a specific time

Table 189 shows the decomposition of the profile into features and features into commands and mode pages.

Table 189 – CD-ROM Profile Decomposition

Features	Commands and Mode Pages
Core Feature	GET CONFIGURATION command, GET EVENT STATUS NOTIFICATION command, INQUIRY command, MODE SELECT (10) command, MODE SENSE (10) command, REQUEST SENSE command, TEST UNIT READY command
Morphing Feature	GET CONFIGURATION command, GET EVENT STATUS NOTIFICATION command, PREVENT ALLOW MEDIUM REMOVAL command, SEND EVENT command
Removable Medium Feature	MECHANISM STATUS command, PREVENT ALLOW MEDIUM REMOVAL command, START STOP UNIT command
Random Readable Feature	READ CAPACITY command, READ (10) command, Read/Write Error Recovery Mode Page
CD Read Feature	READ CD command, READ CD MSF command, READ TOC/PMA/ATIP command
Power Management Feature	GET EVENT STATUS NOTIFICATION command, START STOP UNIT command, Power Condition Mode Page
Timeout Feature	Timeout and Protect Mode Page

5.4.9 Profile 0009h: CD-R

Logical Units identifying Profile 0009h as current shall support the Features listed in Table 190:

Table 190 – Mandatory Features for CD-R

Feature Number	Feature Name	Description
0000h	Profile List	A list of all Profiles supported by the device
0001h	Core	Basic Functionality
0002h	Morphing	The device changes its operational behavior due to external events
0003h	Removable Medium	The medium may be removed from the device
0010h	Random Readable, PP = 1	Read ability for storage with random addressing
001Eh	CD Read	The ability to read CD specific structures
0021h	Incremental Streaming Writable	Write support of sequential recording
002Dh	CD Track at Once	Ability to write CD with Track at Once recording
0100h	Power Management	Initiator and Logical Unit power management
0105h	Timeout	Ability to response to all commands within a specific time
0107h	Real-Time Streaming	Ability to read and write using Initiator requested performance parameters

Table 191 shows the decomposition of the profile into features and features into commands and mode pages.

Table 191 – CD-R Profile Decomposition

Features	Commands and Mode Pages
Core Feature	GET CONFIGURATION command, GET EVENT STATUS NOTIFICATION command, INQUIRY command, MODE SELECT (10) command, MODE SENSE (10) command, REQUEST SENSE command, TEST UNIT READY command
Morphing Feature	GET CONFIGURATION command, GET EVENT STATUS NOTIFICATION command, PREVENT ALLOW MEDIUM REMOVAL command, SEND EVENT command
Removable Medium Feature	MECHANISM STATUS command, PREVENT ALLOW MEDIUM REMOVAL command, START STOP UNIT command
Random Readable Feature	READ CAPACITY command, READ (10) command, Read/Write Error Recovery Mode Page
CD Read Feature	READ CD command, READ CD MSF command, READ TOC/PMA/ATIP command
Incremental Streaming Writable Feature	CLOSE TRACK SESSION command, READ DISC INFORMATION command, READ TRACK INFORMATION command, RESERVE TRACK command, SYNCHRONIZE CACHE command, WRITE (10) command Write Parameters Mode Page
CD Track-At-Once Feature	CLOSE TRACK SESSION command, READ DISC INFORMATION command, READ TRACK INFORMATION command, SYNCHRONIZE CACHE command, WRITE (10) command Write Parameters Mode Page
Power Management Feature	GET EVENT STATUS NOTIFICATION command, START STOP UNIT command, Power Condition Mode Page
Timeout Feature	Timeout and Protect Mode Page
Real-time Streaming Feature	GET PERFORMANCE command, READ (12) command, SET READ-AHEAD command, SET CD SPEED command ¹ , SET STREAMING command, WRITE (12) command ¹
¹ The command or mode page is conditional according to the feature description.	

5.4.10 Profile 000Ah: CD-RW

Logical Units identifying Profile 000Ah as current shall support the Features listed in Table 192.

Table 192 – Mandatory Features for CD-RW

Feature Number	Feature Name	Description
0000h	Profile List	A list of all Profiles supported by the device
0001h	Core	Basic Functionality
0002h	Morphing	The device changes its operational behavior due to external events
0003h	Removable Medium	The medium may be removed from the device
0010h	Random Readable, PP = 1	Read ability for storage with random addressing
001Dh	Multi-Read	The Logical Unit complies with OSTA Multi-Read
001Eh	CD Read	The ability to read CD specific structure
0021h	Incremental Streaming Writable	Write support of sequential recording
0023h	Formattable	Support for formatting of media
0026h	Restricted Overwrite	Write support for media that shall be written in multiples of logical blocks
002Dh	CD Track at Once	Ability to write CD with Track at Once recording
0100h	Power Management	Initiator and Logical Unit power management
0105h	Timeout	Ability to response to all commands within a specific time
0107h	Real-Time Streaming	Ability to read and write using Initiator requested performance parameters

Table 193 shows the decomposition of the profile into features and features into commands and mode pages.

Table 193 – CD-RW Profile Decomposition

Features	Commands and Mode Pages
Core Feature	GET CONFIGURATION command, GET EVENT STATUS NOTIFICATION command, INQUIRY command, MODE SELECT (10) command, MODE SENSE (10) command, REQUEST SENSE command, TEST UNIT READY command
Morphing Feature	GET CONFIGURATION command, GET EVENT STATUS NOTIFICATION command, PREVENT ALLOW MEDIUM REMOVAL command, SEND EVENT command
Removable Medium Feature	MECHANISM STATUS command, PREVENT ALLOW MEDIUM REMOVAL command, START STOP UNIT command
Random Readable Feature	READ CAPACITY command, READ (10) command, Read/Write Error Recovery Mode Page
CD Read Feature	READ CD command, READ CD MSF command, READ TOC/PMA/ATIP command
Incremental Streaming Writable Feature	CLOSE TRACK SESSION command, READ DISC INFORMATION command, READ TRACK INFORMATION command, RESERVE TRACK command, SYNCHRONIZE CACHE command, WRITE (10) command Write Parameters Mode Page
Formatteable Feature	FORMAT UNIT command, READ FORMATTABLE CAPACITIES command, REQUEST SENSE command, VERIFY (10) command
Restricted Overwrite Feature	READ DISC INFORMATION command, READ TRACK INFORMATION command, SYNCHRONIZE CACHE command, WRITE (10) command Write Parameters Mode Page
CD Track-At-Once Feature	CLOSE TRACK SESSION command, READ DISC INFORMATION command, READ TRACK INFORMATION command, SYNCHRONIZE CACHE command, WRITE (10) command Write Parameters Mode Page
Power Management Feature	GET EVENT STATUS NOTIFICATION command, START STOP UNIT command, Power Condition Mode Page
Timeout Feature	Timeout and Protect Mode Page
Real-time Streaming Feature	GET PERFORMANCE command, READ (12) command, SET READ-AHEAD command, SET CD SPEED command ¹ , SET STREAMING command, WRITE (12) command ¹
¹ The command or mode page is conditional according to the feature description.	

5.4.11 Profile 0010h: DVD-ROM

Logical Units identifying Profile 0010h as current shall support the Features listed in Table 194.

Table 194 – Mandatory Features for DVD-ROM

Feature Number	Feature Name	Description
0000h	Profile List	A list of all Profiles supported by the device
0001h	Core	Basic Functionality
0002h	Morphing	The device changes its operational behavior due to external events
0003h	Removable Medium	The medium may be removed from the device
0010h	Random Readable, PP=1	Read ability for storage devices with random addressing.
001Fh	DVD Read	The ability to read DVD specific structures
0100h	Power Management	Initiator and device directed power management
0105h	Timeout	Ability to respond to all commands within a specific time
0107h	Real-Time Streaming	Ability to read using Initiator requested performance parameters

Table 195 shows the decomposition of the profile into features and features into commands and mode pages.

Table 195 – DVD-ROM Profile Decomposition

Features	Commands and Mode Pages
Core Feature	GET CONFIGURATION command, GET EVENT STATUS NOTIFICATION command, INQUIRY command, MODE SELECT (10) command, MODE SENSE (10) command, REQUEST SENSE command, TEST UNIT READY command
Morphing Feature	GET CONFIGURATION command, GET EVENT STATUS NOTIFICATION command, PREVENT ALLOW MEDIUM REMOVAL command, SEND EVENT command
Removable Medium Feature	MECHANISM STATUS command, PREVENT ALLOW MEDIUM REMOVAL command, START STOP UNIT command
Random Readable Feature	READ CAPACITY command, READ (10) command, Read/Write Error Recovery Mode Page
DVD Read Feature	READ (10) command, READ DVD STRUCTURE command, READ TOC/PMA/ATIP command
Power Management Feature	GET EVENT STATUS NOTIFICATION command, START STOP UNIT command, Power Condition mode page
Timeout Feature	Timeout and Protect Mode Page
Real-time Streaming Feature	GET PERFORMANCE command, READ (12) command, SET READ-AHEAD command, SET CD SPEED command ¹ , SET STREAMING command, WRITE (12) command ¹
¹ The command or mode page is conditional according to the feature description.	

5.4.12 Profile 0011h: DVD-R Sequential recording

Logical Units identifying Profile 0011h as current shall support the Features listed in Table 196:

Table 196 – Mandatory Features for DVD-R Sequential recording

Feature Number	Feature Name	Description
0000h	Profile List	A list of all Profiles supported by the device
0001h	Core	Basic Functionality
0002h	Morphing	The device changes its operational behavior due to external events
0003h	Removable Medium	The medium may be removed from the device
0010h	Random Readable, PP = 1	Read ability for storage with random addressing
001Fh	DVD Read	The ability to respond to all commands within a specific time
0021h	Incremental Streaming Writable	Write support for sequential recording
002Fh	DVD-R/-RW Write	Ability to write data in Disc At Once mode
0100h	Power Management	Initiator and Logical Unit power management
0105h	Timeout	Ability to response to all commands within a specific time
0107h	Real-Time Streaming	Ability to read and write using Initiator requested performance parameters
0108h	Logical Unit Serial Number	Ability to provide Logical Unit serial number

Table 197 shows the decomposition of the profile into features and features into commands and mode pages.

Table 197 – DVD-R Sequential Recording Profile Decomposition

Features	Commands and Mode Pages
Core Feature	GET CONFIGURATION command, GET EVENT STATUS NOTIFICATION command, INQUIRY command, MODE SELECT (10) command, MODE SENSE (10) command, REQUEST SENSE command, TEST UNIT READY command
Morphing Feature	GET CONFIGURATION command, GET EVENT STATUS NOTIFICATION command, PREVENT ALLOW MEDIUM REMOVAL command, SEND EVENT command
Removable Medium Feature	MECHANISM STATUS command, PREVENT ALLOW MEDIUM REMOVAL command, START STOP UNIT command
Random Readable Feature	READ CAPACITY command, READ (10) command, Read/Write Error Recovery Mode Page
DVD Read Feature	READ (10) command, READ DVD STRUCTURE command, READ TOC/PMA/ATIP command
Incremental Streaming Writable Feature	CLOSE TRACK SESSION command, READ DISC INFORMATION command, READ TRACK INFORMATION command, RESERVE TRACK command, SYNCHRONIZE CACHE command, WRITE (10) command, Write Parameters Mode Page
DVD-R/-RW Write	CLOSE TRACK SESSION command, READ DISC INFORMATION command, READ TRACK INFORMATION command, RESERVE TRACK command, SEND DVD STRUCTURE command, SYNCHRONIZE CACHE command, WRITE (10) command Write Parameters Mode Page
Power Management Feature	GET EVENT STATUS NOTIFICATION command, START STOP UNIT command, Power Condition mode page
Timeout Feature	Timeout and Protect Mode Page
Real-time Streaming Feature	GET PERFORMANCE command, READ (12) command, SET READ-AHEAD command, SET CD SPEED command ¹ , SET STREAMING command, WRITE (12) command ¹
Logical Unit Serial Number Feature	—
¹ The command or mode page is conditional according to the feature description.	

5.4.13 Profile 0012h: DVD-RAM

Logical Units identifying Profile 0012h as current shall support the Features listed in Table 198.

Table 198 – Mandatory Features for DVD-RAM

Feature Number	Feature Name	Description
0000h	Profile List	A list of all Profiles supported by the device
0001h	Core	Basic Functionality
0002h	Morphing	The device changes its operational behavior due to external events
0003h	Removable Medium	The medium may be removed from the device
0010h	Random Readable, PP=1	Read ability for storage devices with random addressing.
001Fh	DVD Read	The ability to read DVD specific structures.
0020h	Random Writable	Write support for randomly addressed writes
0023h	Formattable	Support for formatting of media
0024h	Defect Management	Ability of the Logical Unit/media system to provide an apparently defect-free space
0100h	Power Management	Initiator and device directed power management
0105h	Timeout	Ability to respond to all commands within a specific time
0107h	Real-Time Streaming	Ability to read and write using Initiator requested performance parameters.

Table 199 shows the decomposition of the profile into features and features into commands and mode pages.

Table 199 – DVD-RAM Profile Decomposition

Features	Commands and Mode Pages
Core Feature	GET CONFIGURATION command, GET EVENT STATUS NOTIFICATION command, INQUIRY command, MODE SELECT (10) command, MODE SENSE (10) command, REQUEST SENSE command, TEST UNIT READY command
Morphing Feature	GET CONFIGURATION command, GET EVENT STATUS NOTIFICATION command, PREVENT ALLOW MEDIUM REMOVAL command, SEND EVENT command
Removable Medium Feature	MECHANISM STATUS command, PREVENT ALLOW MEDIUM REMOVAL command, START STOP UNIT command
Random Readable Feature	READ CAPACITY command, READ (10) command, Read/Write Error Recovery Mode Page
DVD Read Feature	READ (10) command, READ DVD STRUCTURE command, READ TOC/PMA/ATIP command
Random Writable Feature	READ CAPACITY command, WRITE (10) command, WRITE AND VERIFY (10) command, SYNCHRONIZE CACHE command
Formattable Feature	FORMAT UNIT command, READ FORMATTABLE CAPACITIES command, REQUEST SENSE command, VERIFY (10) command
Defect Management Feature	Read/Write Error Recovery Mode Page
Power Management Feature	GET EVENT STATUS NOTIFICATION command, START STOP UNIT command, Power Condition mode page
Timeout Feature	Timeout and Protect Mode Page
Real-time Streaming Feature	GET PERFORMANCE command, READ (12) command, SET READ-AHEAD command, SET CD SPEED command ¹ , SET STREAMING command, WRITE (12) command ¹

¹The command or mode page is conditional according to the feature description.

5.4.14 Profile 0013h: DVD-RW Restricted Overwrite

Logical Units identifying Profile 0013h as current shall support the Features listed in Table 200.

Table 200 – Mandatory Features for DVD-RW Restricted Overwrite

Feature Number	Feature Name	Description
0000h	Profile List	A list of all Profiles supported by the device
0001h	Core	Basic Functionality
0002h	Morphing	The device changes its operational behavior due to external events
0003h	Removable Medium	The medium may be removed from the device
0010h	Random Readable, PP=1	Read ability for storage devices with random addressing.
001Fh	DVD Read	The ability to read DVD specific structures.
0023h	Formattable	Support for formatting of media
002Ch	Rigid Restricted Overwrite	Ability to write DVD-RW specific structure
0100h	Power Management	Initiator and device directed power management
0105h	Timeout	Ability to respond to all commands within a specific time
0107h	Real-Time Streaming	Ability to read and write using Initiator requested performance parameters.
0108h	Logical Unit Serial Number	Ability to provide Logical Unit serial number

Table 201 shows the decomposition of the profile into features and features into commands and mode pages.

Table 201 – DVD-RW Restricted Overwrite Profile Decomposition

Features	Commands and Mode Pages
Core Feature	GET CONFIGURATION command, GET EVENT STATUS NOTIFICATION command, INQUIRY command, MODE SELECT (10) command, MODE SENSE (10) command, REQUEST SENSE command, TEST UNIT READY command
Morphing Feature	GET CONFIGURATION command, GET EVENT STATUS NOTIFICATION command, PREVENT ALLOW MEDIUM REMOVAL command, SEND EVENT command
Removable Medium Feature	MECHANISM STATUS command, PREVENT ALLOW MEDIUM REMOVAL command, START STOP UNIT command
Random Readable Feature	READ CAPACITY command, READ (10) command, Read/Write Error Recovery Mode Page
DVD Read Feature	READ (10) command, READ DVD STRUCTURE command, READ TOC/PMA/ATIP command
Formattable Feature	FORMAT UNIT command, READ FORMATTABLE CAPACITIES command, REQUEST SENSE command, VERIFY (10) command
Rigid Restricted Overwrite Feature	BLANK command ¹ , GET PERFORMANCE command ¹ , READ DISC INFORMATION command, READ TRACK INFORMATION command, SYNCHRONIZE CACHE command, WRITE (10) command, Write Parameters Mode Page
Power Management Feature	GET EVENT STATUS NOTIFICATION command, START STOP UNIT command, Power Condition mode page
Timeout Feature	Timeout and Protect Mode Page
Real-time Streaming Feature	GET PERFORMANCE command, READ (12) command, SET READ-AHEAD command, SET CD SPEED command ¹ , SET STREAMING command, WRITE (12) command ¹
Logical Unit Serial Number Feature	—
¹ The command or mode page is conditional according to the feature description.	

5.4.15 Profile 0014h: DVD-RW Sequential recording

Logical Units identifying Profile 0014h as current shall support the Features listed in Table 202:

Table 202 – Mandatory Features for DVD-RW Sequential recording

Feature Number	Feature Name	Description
0000h	Profile List	A list of all Profiles supported by the device
0001h	Core	Basic Functionality
0002h	Morphing	The device changes its operational behavior due to external events
0003h	Removable Medium	The medium may be removed from the device
0010h	Random Readable, PP = 1	Read ability for storage with random addressing
001Fh	DVD Read	The ability to respond to all commands within a specific time
0021h	Incremental Streaming Writable	Write support for sequential recording
002Fh	DVD-R/-RW Write	Ability to write data in Disc At Once mode
0100h	Power Management	Initiator and Logical Unit power management
0105h	Timeout	Ability to response to all commands within a specific time
0107h	Real-Time Streaming	Ability to read and write using Initiator requested performance parameters
0108h	Logical Unit Serial Number	Ability to provide Logical Unit serial number

Table 203 shows the decomposition of the profile into features and features into commands and mode pages.

Table 203 – DVD-RW Sequential Recording Profile Decomposition

Features	Commands and Mode Pages
Core Feature	GET CONFIGURATION command, GET EVENT STATUS NOTIFICATION command, INQUIRY command, MODE SELECT (10) command, MODE SENSE (10) command, REQUEST SENSE command, TEST UNIT READY command
Morphing Feature	GET CONFIGURATION command, GET EVENT STATUS NOTIFICATION command, PREVENT ALLOW MEDIUM REMOVAL command, SEND EVENT command
Removable Medium Feature	MECHANISM STATUS command, PREVENT ALLOW MEDIUM REMOVAL command, START STOP UNIT command
Random Readable Feature	READ CAPACITY command, READ (10) command, Read/Write Error Recovery Mode Page
DVD Read Feature	READ (10) command, READ DVD STRUCTURE command, READ TOC/PMA/ATIP command
Incremental Streaming Writable Feature	CLOSE TRACK SESSION command, READ DISC INFORMATION command, READ TRACK INFORMATION command, RESERVE TRACK command, SYNCHRONIZE CACHE command, WRITE (10) command Write Parameters Mode Page
DVD-R/-RW Write	CLOSE TRACK SESSION command, READ DISC INFORMATION command, READ TRACK INFORMATION command, RESERVE TRACK command, SEND DVD STRUCTURE command, SYNCHRONIZE CACHE command, WRITE (10) command Write Parameters Mode Page
Power Management Feature	GET EVENT STATUS NOTIFICATION command, START STOP UNIT command, Power Condition Mode Page
Timeout Feature	Timeout and Protect Mode Page
Real-time Streaming Feature	GET PERFORMANCE command, READ (12) command, SET READ-AHEAD command, SET CD SPEED command ¹ , SET STREAMING command, WRITE (12) command ¹
Logical Unit Serial Number Feature	—
¹ The command or mode page is conditional according to the feature description.	

5.4.16 Profile 001Ah: DVD+RW

Logical Units identifying Profile 001Ah as current shall support the features listed in Table 204.

Table 204 – Mandatory Features for DVD+RW

Feature Number	Feature Name	Description
0000h	Profile List	A list of all Profiles supported by the device
0001h	Core	Mandatory behavior for all devices
0002h	Morphing	The device changes its operational behavior due to external events
0003h	Removable Medium	The medium may be removed from the device
0010h	Random Readable, PP=1	Read ability for storage devices with random addressing
001Fh	DVD Read	The ability to read DVD specific structures
0020h	Random Writable ¹	Write support for randomly addressed writes
0023h	Formattable ¹	Support for formatting of media
002Ah	DVD+RW	Support for reading and optionally writing DVD+RW Media
0100h	Power Management	Initiator and device directed power management
0105h	Timeout	Ability to respond to all commands within a specific time
0107h	Real-time Streaming	Ability to read and write using Initiator requested performance parameters
010Ah	DCBs	The ability to read and optionally write DCBs.

¹This feature is mandatory only when the Write bit of the DVD+RW Feature is set to one.

Table 205 shows the decomposition of the profile into features and features into commands and mode pages.

Table 205 – DVD+RW Profile Decomposition

Features	Commands and Mode Pages
Core Feature	GET CONFIGURATION command, GET EVENT STATUS NOTIFICATION command, INQUIRY command, MODE SELECT (10) command, MODE SENSE (10) command, REQUEST SENSE command, TEST UNIT READY command
Morphing Feature	GET CONFIGURATION command, GET EVENT STATUS NOTIFICATION command, PREVENT ALLOW MEDIUM REMOVAL command, SEND EVENT command
Removable Medium Feature	MECHANISM STATUS command, PREVENT ALLOW MEDIUM REMOVAL command, START STOP UNIT command
Random Readable Feature	READ CAPACITY command, READ (10) command, Read/Write Error Recovery Mode Page
DVD Read Feature	READ (10) command, READ DVD STRUCTURE command, READ TOC/PMA/ATIP command
Random Writable Feature (When Write=1 in DVD+RW Feature)	READ CAPACITY command, WRITE (10) command, WRITE AND VERIFY (10) command, SYNCHRONIZE CACHE command
Formattable Feature (When Write=1 in DVD+RW Feature)	FORMAT UNIT command, READ FORMATTABLE CAPACITIES command, REQUEST SENSE command, VERIFY (10) command
DVD+RW Feature	CLOSE TRACK SESSION command ¹ , FORMAT UNIT command ¹ , READ DVD STRUCTURE command, READ TOC/PMA/ATIP command, SEND DVD STRUCTURE command ¹ , WRITE (10) command ¹ , WRITE (12) command ¹ , WRITE AND VERIFY (10) command ¹
Power Management Feature	GET EVENT STATUS NOTIFICATION command, START STOP UNIT command, Power Condition Mode Page
Timeout Feature	Timeout and Protect Mode Page
Real-time Streaming Feature	GET PERFORMANCE command, READ (12) command, SET READ-AHEAD command, SET CD SPEED command ¹ , SET STREAMING command, WRITE (12) command ¹
DCBs	Read DVD Structure Command, Send DVD Structure Command

¹The command or mode page is conditional according to the feature description.

5.4.17 Profile 001Bh: DVD+R

Logical units identifying Profile 001B as current shall support the features listed in Table 206.

Table 206 – Mandatory Features for DVD+R

Feature Number	Feature Name	Description
0000h	Profile List	A list of all Profiles supported by the device
0001h	Core	Mandatory behavior for all devices
0002h	Morphing	The device changes its operational behavior due to external events
0003h	Removable Medium	The medium may be removed from the device
0010h	Random Readable, PP=1	Read ability for storage devices with random addressing
001Fh	DVD Read	The ability to read DVD specific structures
002Bh	DVD+R	Support for reading and optionally writing DVD+R Media and formats
0100h	Power Management	Initiator and device directed power management
0105h	Timeout	Ability to respond to all commands within a specific time
0107h	Real-time Streaming	Ability to read and write using Initiator requested performance parameters
010Ah	DCBs	The ability to read and optionally write DCBs.

Table 207 shows the decomposition of the profile into features and features into commands and mode pages.

Table 207 – DVD+R Profile Decomposition

Features	Commands and Mode Pages
Core Feature	GET CONFIGURATION command, GET EVENT STATUS NOTIFICATION command, INQUIRY command, MODE SELECT (10) command, MODE SENSE (10) command, REQUEST SENSE command, TEST UNIT READY command
Morphing Feature	GET CONFIGURATION command, GET EVENT STATUS NOTIFICATION command, PREVENT ALLOW MEDIUM REMOVAL command, SEND EVENT command
Removable Medium Feature	MECHANISM STATUS command, PREVENT ALLOW MEDIUM REMOVAL command, START STOP UNIT command
Random Readable Feature	READ CAPACITY command, READ (10) command, Read/Write Error Recovery Mode Page
DVD Read Feature	READ (10) command, READ DVD STRUCTURE command, READ TOC/PMA/ATIP command
Formattable Feature	FORMAT UNIT command, READ FORMATTABLE CAPACITIES command, REQUEST SENSE command, VERIFY (10) command
DVD+R Feature	CLOSE TRACK SESSION command ¹ , READ DISC INFO command ¹ , READ DVD STRUCTURE command ¹ , READ TOC/PMA/ATIP command ¹ , READ TRACK INFO command ¹ , RESERVE TRACK command ¹ , SEND DVD STRUCTURE command ¹ , SYNCHRONIZE CACHE command ¹ , WRITE (10) command ¹ , WRITE (12) command ¹
Power Management Feature	GET EVENT STATUS NOTIFICATION command, START STOP UNIT command, Power Condition Mode Page
Timeout Feature	Timeout and Protect Mode Page
Real-time Streaming Feature	GET PERFORMANCE command, READ (12) command, SET READ-AHEAD command, SET CD SPEED command ¹ , SET STREAMING command, WRITE (12) command ¹
DCBs	READ DVD STRUCTURE command, SEND DVD STRUCTURE command
¹ The command or mode page is conditional according to the feature description.	

The DVD+R Profile does not contain the Incremental Streaming Write Feature because DVD+R does not support WRITE PARAMETERS mode page.

5.4.18 Profile 0020h: DDCD-ROM

Logical Units identifying Profile 0020h as current shall support the Features listed in Table 208.

Table 208 – Mandatory Feature List for the DDCD-ROM

Feature Number	Feature Name	Description
0000h	Profile List	A list of all Profiles supported by the device
0001h	Core	Basic Functionality
0002h	Morphing	The device changes its operational behavior due to external events
0003h	Removable Medium	The medium may be removed from the device
0010h	Random Readable, PP = 1	Read ability for storage with random addressing
0030h	DDCD Read	The ability to read DDCD specific structure
0100h	Power Management	Initiator and device directed power management.
0105h	Timeout	Ability to response to all commands within a specific time

Table 209 shows the decomposition of the profile into features and features into commands and mode pages.

Table 209 – DDCD-ROM Profile Decomposition

Features	Commands and Mode Pages
Core Feature	GET CONFIGURATION command, GET EVENT STATUS NOTIFICATION command, INQUIRY command, MODE SELECT (10) command, MODE SENSE (10) command, REQUEST SENSE command, TEST UNIT READY command
Morphing Feature	GET CONFIGURATION command, GET EVENT STATUS NOTIFICATION command, PREVENT ALLOW MEDIUM REMOVAL command, SEND EVENT command
Removable Medium Feature	MECHANISM STATUS command, PREVENT ALLOW MEDIUM REMOVAL command, START STOP UNIT command
Random Readable Feature	READ CAPACITY command, READ (10) command, Read/Write Error Recovery Mode Page
DDCD Read Feature	
Power Management Feature	GET EVENT STATUS NOTIFICATION command, START STOP UNIT command, Power Condition Mode Page
Timeout Feature	Timeout and Protect Mode Page
¹ The command or mode page is conditional according to the feature description.	

5.4.19 Profile 0021h: DDCD-R

Logical Units identifying Profile 0021h as current shall support the Features listed in Table 210.

Table 210 – Mandatory Feature List for the DDCD-R

Feature Number	Feature Name	Description
0000h	Profile List	A list of all Profiles supported by the device
0001h	Core	Basic Functionality
0002h	Morphing	The device changes its operational behavior due to external events
0003h	Removable Medium	The medium may be removed from the device
0010h	Random Readable, PP = 1	Read ability for storage with random addressing
0021h	Incremental Streaming Writable	Write support of sequential recording
0030h	DDCD Read	The ability to read DDCD specific structure
0031h	DDCD-R Write	The ability to write DDCD-R specific structure
0100h	Power Management	Initiator and Logical Unit power management.
0105h	Timeout	Ability to response to all commands within a specific time
0107h	Real-Time Streaming	Ability to read and write using Initiator requested performance parameters

Table 211 shows the decomposition of the profile into features and features into commands and mode pages.

Table 211 – DDCD-R Profile Decomposition

Core Feature	GET CONFIGURATION command, GET EVENT STATUS NOTIFICATION command, INQUIRY command, MODE SELECT (10) command, MODE SENSE (10) command, REQUEST SENSE command, TEST UNIT READY command
Morphing Feature	GET CONFIGURATION command, GET EVENT STATUS NOTIFICATION command, PREVENT ALLOW MEDIUM REMOVAL command, SEND EVENT command
Removable Medium Feature	MECHANISM STATUS command, PREVENT ALLOW MEDIUM REMOVAL command, START STOP UNIT command
Random Readable Feature	READ CAPACITY command, READ (10) command, Read/Write Error Recovery Mode Page
Incremental Streaming Writable Feature	CLOSE TRACK SESSION command, READ DISC INFORMATION command, READ TRACK INFORMATION command, RESERVE TRACK command, SYNCHRONIZE CACHE command, WRITE (10) command, Write Parameters Mode Page
DDCD Read Feature	READ CD command, READ TOC/PMA/ATIP command
DDCD-R Write	READ DISC INFORMATION command, READ TRACK INFORMATION command, RESERVE TRACK command, WRITE (10) command, WRITE (12) command, Write Parameters Mode Page
Power Management Feature	GET EVENT STATUS NOTIFICATION command, START STOP UNIT command, Power Condition Mode Page
Timeout Feature	Timeout and Protect Mode Page
Real-time Streaming Feature	GET PERFORMANCE command, READ (12) command, SET READ-AHEAD command, SET CD SPEED command ¹ , SET STREAMING command, WRITE (12) command ¹

¹The command or mode page is conditional according to the feature description.

5.4.20 Profile 0022h: DDCD-RW

Logical Units identifying Profile 0022h as current shall support the Features listed in Table 212.

Table 212 – Mandatory Feature List for the DDCD-R/RW

Feature Number	Feature Name	Description
0000h	Profile List	A list of all Profiles supported by the device
0001h	Core	Basic Functionality
0002h	Morphing	The device changes its operational behavior due to external events
0003h	Removable Medium	The medium may be removed from the device
0010h	Random Readable, PP = 1	Read ability for storage with random addressing
0020h	Random Writable	Write support for randomly addressed writes
0021h	Incremental Streaming Writable	Write support of sequential recording
0023h	Formattable	Support for formatting of media
0026h	Restricted Overwrite	Write support for media that shall be written in multiples of logical blocks
0030h	DDCD Read	The ability to read DDCD specific structure
0031h	DDCD-R Write	The ability to write DDCD-R specific structure
0032h	DDCD-RW Write	The ability to write DDCD-RW specific structure
0100h	Power Management	Initiator and Logical Unit power management.
0105h	Timeout	Ability to response to all commands within a specific time
0107h	Real-Time Streaming	Ability to read and write using Initiator requested performance parameters

Table 213 shows the decomposition of the profile into features and features into commands and mode pages.

Table 213 – DDCD-RW Profile Decomposition

Features	Commands and Mode Pages
Core Feature	GET CONFIGURATION command, GET EVENT STATUS NOTIFICATION command, INQUIRY command, MODE SELECT (10) command, MODE SENSE (10) command, REQUEST SENSE command, TEST UNIT READY command
Morphing Feature	GET CONFIGURATION command, GET EVENT STATUS NOTIFICATION command, PREVENT ALLOW MEDIUM REMOVAL command, SEND EVENT command
Removable Medium Feature	MECHANISM STATUS command, PREVENT ALLOW MEDIUM REMOVAL command, START STOP UNIT command
Random Readable Feature	READ CAPACITY command, READ (10) command, Read/Write Error Recovery Mode Page
Incremental Streaming Writable Feature	CLOSE TRACK SESSION command, READ DISC INFORMATION command, READ TRACK INFORMATION command, RESERVE TRACK command, SYNCHRONIZE CACHE command, WRITE (10) command Write Parameters Mode Page
Formattable Feature	FORMAT UNIT command, READ FORMATTABLE CAPACITIES command, REQUEST SENSE command, VERIFY (10) command
Restricted Overwrite Feature	READ DISC INFORMATION command, READ TRACK INFORMATION command, SYNCHRONIZE CACHE command, WRITE (10) command Write Parameters Mode Page
DDCD Read Feature	READ CD command, READ TOC/PMA/ATIP command
DDCD-R Write Feature	READ DISC INFORMATION command, READ TRACK INFORMATION command, RESERVE TRACK command, WRITE (10) command, WRITE (12) command Write Parameters Mode Page
DDCD-RW Write Feature	BLANK command ¹ , READ DISC INFORMATION command, READ TRACK INFORMATION command, RESERVE TRACK command, WRITE (10) command, WRITE (12) command, Write Parameters Mode Page
Power Management Feature	GET EVENT STATUS NOTIFICATION command, START STOP UNIT command, Power Condition Mode Page
Timeout Feature	Timeout and Protect Mode Page
Real-time Streaming Feature	GET PERFORMANCE command, READ (12) command, SET READ-AHEAD command, SET CD SPEED command ¹ , SET STREAMING command, WRITE (12) command ¹
¹ The command or mode page is conditional according to the feature description.	

5.4.21 Profile FFFFh: Logical Units Not Conforming to a Standard Profile

Profile FFFFh is reported for media that has no defined profile.

Logical Units identifying Profile FFFFh as current shall support the Features listed in Table 214.

Table 214 – Mandatory Features for Logical Units Not Conforming to a Standard Profile

Feature Number	Feature Name	Description
0000h	Profile List	A list of all Profiles supported by the device
0001h	Core	Basic Functionality

6 Commands for Multi-Media Devices

6.1 Overview

The commands described in this clause are defined uniquely for Multi-Media Logical Units or have a unique behavior when performed by a Multi-Media Logical Unit.

Certain commands or command options that were present in earlier versions of this standard have been defined as Legacy and are no longer recommended for use in Multi-Media devices and are not described in this clause. Those commands and command options are described in Annex E.

Some commands that may be implemented by MM Logical Units are not described in this standard, but are found in other SCSI standards. For a complete list of these commands refer to SPC-3.

The commands described in this clause are listed in Table 215 and Table 216.

Table 215 – Commands for Multi-Media Logical Units (Alphabetic order)

Command Name	Op Code	Reference	Command Name	Op Code	Reference
BLANK	A1h	6.2	READ FORMAT CAPACITIES	23h	6.28
CLOSE TRACK/SESSION	5Bh	6.3	READ SUB-CHANNEL	42h	6.29
ERASE (10)	2Ch	6.4	READ TOC/PMA/ATIP	43h	6.30
FORMAT UNIT	04h	6.5	READ TRACK INFORMATION	52h	6.31
GET CONFIGURATION	46h	6.6	REPAIR TRACK	58h	6.32
GET EVENT STATUS NOTIFICATION	4Ah	6.7	REPORT KEY	A4h	6.33
GET PERFORMANCE	ACh	6.8	REQUEST SENSE	03h	6.34
INQUIRY	12h	6.9	RESERVE TRACK	53h	6.35
LOAD/UNLOAD MEDIUM	A6h	6.10	SCAN	BAh	6.36
MECHANISM STATUS	BDh	6.11	SEEK (10)	2Bh	6.37
MODE SELECT (10)	55h	6.12	SEND CUE SHEET	5Dh	6.38
MODE SENSE (10)	5Ah	6.13	SEND DVD STRUCTURE	BFh	6.39
PAUSE/RESUME	4Bh	6.14	SEND KEY	A3h	6.40
PLAY AUDIO (10)	45h	6.15	SEND OPC INFORMATION	54h	6.41
PLAY AUDIO (12)	A5h	6.16	SET CD SPEED	BBh	6.42
PLAY AUDIO MSF	47h	6.17	SET READ AHEAD	A7h	6.43
PREVENT ALLOW MEDIUM REMOVAL	1Eh	6.18	SET STREAMING	B6h	6.44
READ (10)	28h	6.19	START STOP UNIT	1Bh	6.45
READ (12)	A8h	6.20	STOP PLAY/SCAN	4Eh	6.46
READ BUFFER	3Ch	6.21	SYNCHRONIZE CACHE	35h	6.47
READ BUFFER CAPACITY	5Ch	6.22	TEST UNIT READY	00h	6.48
READ CAPACITY	25h	6.23	VERIFY (10)	2Fh	6.49
READ CD	BEh	6.24	WRITE (10)	2Ah	6.50
READ CD MSF	B9h	6.25	WRITE (12)	AAh	6.51
READ DISC INFORMATION	51h	6.26	WRITE AND VERIFY (10)	2Eh	6.52
READ DVD STRUCTURE	ADh	6.27	WRITE BUFFER	3Bh	6.53

Table 216 – Commands for Multi-Media Logical Units (Opcode order)

Command Name	Op Code	Reference	Command Name	Op Code	Reference
TEST UNIT READY	00h	6.48	READ TRACK INFORMATION	52h	6.31
REQUEST SENSE	03h	6.34	RESERVE TRACK	53h	6.35
FORMAT UNIT	04h	6.5	SEND OPC INFORMATION	54h	6.41
INQUIRY	12h	6.9	MODE SELECT (10)	55h	6.12
START STOP UNIT	1Bh	6.45	REPAIR TRACK	58h	6.32
PREVENT ALLOW MEDIUM REMOVAL	1Eh	6.18	MODE SENSE (10)	5Ah	6.13
READ FORMAT CAPACITIES	23h	6.28	CLOSE TRACK/SESSION	5Bh	6.3
READ CAPACITY	25h	6.23	READ BUFFER CAPACITY	5Ch	6.22
READ (10)	28h	6.19	SEND CUE SHEET	5Dh	6.38
WRITE (10)	2Ah	6.50	BLANK	A1h	6.2
SEEK (10)	2Bh	6.37	SEND KEY	A3h	6.40
ERASE (10)	2Ch	6.4	REPORT KEY	A4h	6.33
WRITE AND VERIFY (10)	2Eh	6.52	PLAY AUDIO (12)	A5h	6.16
VERIFY (10)	2Fh	6.49	LOAD/UNLOAD MEDIUM	A6h	6.10
SYNCHRONIZE CACHE	35h	6.47	SET READ AHEAD	A7h	6.43
WRITE BUFFER	3Bh	6.53	READ (12)	A8h	6.20
READ BUFFER	3Ch	6.21	WRITE (12)	AAh	6.51
READ SUB-CHANNEL	42h	6.29	GET PERFORMANCE	ACh	6.8
READ TOC/PMA/ATIP	43h	6.30	READ DVD STRUCTURE	ADh	6.27
PLAY AUDIO (10)	45h	6.15	SET STREAMING	B6h	6.44
GET CONFIGURATION	46h	6.6	READ CD MSF	B9h	6.25
PLAY AUDIO MSF	47h	6.17	SCAN	BAh	6.36
GET EVENT STATUS NOTIFICATION	4Ah	6.7	SET CD SPEED	BBh	6.42
PAUSE/RESUME	4Bh	6.14	MECHANISM STATUS	BDh	6.11
STOP PLAY/SCAN	4Eh	6.46	READ CD	BEh	6.24
READ DISC INFORMATION	51h	6.26	SEND DVD STRUCTURE	BFh	6.39

6.2 BLANK Command

6.2.1 Introduction

ReWritable media that reports either the Restricted Overwrite Feature or the Rigid Restricted Overwrite Feature carries the restriction that it shall be recorded in a sequential way. When those features are present, it becomes necessary to provide a re-initialization of the media to the blank state. The blanking action performed may be either Logical or physical. e.g., CD-RW data is overwritten with Mode 0 data, while the blanking action performed on DVD-RW is a physical erase.

The BLANK command provides this capability. Features that specify the use of the BLANK command are listed in Table 217.

Table 217 – Features Associated with the BLANK Command

Feature Number	Feature Name	Command Requirement
0021h	Incremental Streaming Writable	Mandatory for DD/CD-RW and DVD-RW
002Ch	Rigid Restricted Overwrite	Mandatory for DVD-RW
002Dh	CD Track At Once	Mandatory for DD/CD-RW
002Fh	DVD-R/-RW Write	Mandatory for DVD-RW

NOTE 1: The command requirement is valid only when the feature is current.

6.2.2 The CDB and its Parameters

6.2.2.1 The CDB

The BLANK CDB is shown in Table 218.

Table 218 – BLANK CDB

Bit	7	6	5	4	3	2	1	0
0	Operation Code (A1h)							
1	Reserved			IMMED	Reserved	Blanking Type		
2	(MSB) Start Address/Track Number (LSB)							
3								
4								
5								
6								
7	Reserved							
8	Reserved							
9	Reserved							
10	Reserved							
11	Control Byte							

6.2.2.2 IMMED

If IMMED is zero, then the requested operation is processed to completion prior to returning status. If IMMED is one, then status is returned once the operation has begun.

6.2.2.3 Blanking Type

Blanking Type identifies the method and coverage of blanking. Blanking Type codes for CD-RW are defined in Table 219 and Blanking Type codes for DVD-RW are defined in Table 220.

6.2.2.4 Start Address/Track Number

Start Address/Track Number meanings are defined within the specific Blanking Type cases (Table 219 and Table 220).

Table 219 – Blanking Types CD-RW and DDCD-RW

Value	Name	Description
000b	Blank the disc	The entire disc is to be blanked. The Start Address parameter is ignored. This is used for clearing the entire disc. The PCA may be excluded. At completion of the operation, the entire PMA, the area from the start time of the lead-in through the last possible start time of lead-out plus 6 750 blocks.
001b	Minimally blank the disc	Blanks only the PMA, disc lead-in and the pre-gap of the first track. The Start Address parameter is ignored. This is used for blanking a disc quickly. After completion of this command the disc is treated as a blank disc. Caution should be exercised when using this command since the program area may still contain user data.
010b	Blank a Track	Blanks the track specified in the Start Address/Track Number field. This command blanks the track only, it does not blank the TOC or the PMA. The track to be blanked shall be in the incomplete session. If the Start Address/Track Number does not reference a track in the incomplete session, then this command shall be terminated with CHECK CONDITION status and SK/ASC/ASCQ values shall be set to ILLEGAL REQUEST/INVALID FIELD IN CDB.
011b	Un-reserve a Track	All data for the last track in the incomplete session shall be blanked. If the track has a PMA entry, the PMA entry shall be blanked. If the disc is blank, the command shall be terminated with GOOD status. The Start Address/Track Number parameter is ignored.
100b	Blank a Track Tail	This blank type is valid only for packet tracks within the incomplete session. If Start Address/Track Number specifies a valid LBA within a track and the LBA is the first sector of a packet, then the area between the LBA and the end of the track that shall be blanked. If the LBA does not exist in any track within the incomplete session, or if the LBA is not the first sector of a packet, then the command shall be terminated with CHECK CONDITION status and SK/ASC/ASCQ values shall be set to ILLEGAL REQUEST/LOGICAL BLOCK ADDRESS OUT OF RANGE. If the track is not a packet track, then this command shall be terminated with CHECK CONDITION status and SK/ASC/ASCQ values shall be set to ILLEGAL REQUEST/INVALID FIELD IN CDB.
101b	Unclose the last complete session	If the disc is blank or the last session is not empty and not closed, then this command shall be terminated with GOOD status. If the last session is empty or if the disc is finalized, the Lead-in and Lead-out of the last complete session shall be blanked.
110b	Blank the last non-empty Session	If the last session is empty, then the Lead-in, program area, and Lead-out of the last complete session shall be blanked. If the last session is incomplete, its program area shall be blanked. Each PMA item for each track in the newly blanked session shall be blanked. If the disc is blank, the command shall be terminated with GOOD status.
111b	Reserved	

Table 220 – Blanking Types for DVD-RW media

Value	Name	Description
000b	Blank the disc	The entire disc is to be blanked. The area from the RMA through the end of Last address of data area plus 3 ECC blocks into the lead-out area shall be blanked. The RMA Lead-in and six RMD blocks at the beginning of RMA shall not be blanked. The Start Address or Track Number parameter is ignored. If a disc is to be blanked that is already fully blanked, no error shall be reported.
001b	Minimally blank the disc	This operation is used for blanking a disc quickly. The Lead-in and the RMA shall be blanked. The RMA Lead-in and six RMD blocks at the beginning of RMA shall not be blanked. The Start Address or Track Number parameter is ignored. Caution should be exercised when using this command since the data area still contains user data. If a disc is to be blanked that is already fully/minimally blanked, no error shall be reported.
010b	Reserved	
011b	Un-reserve a Track	This operation is valid only when the last session has the incomplete state. If the last track is invisible, the track that immediately precedes the invisible track and its RMD entry are blanked. If the last track is incomplete, the incomplete track is blanked. The Start Address or Track Number parameter is ignored.
100b	Blank a Track Tail	This blanking type is valid for only a incrementally recorded track. The track to be blanked shall be in an incomplete session. Blank the area between the LBA specified in Start Address or Track Number field and the end of the track that includes the LBA specified. When the track that is to be blanked is complete track and if the next track is recorded, the last ECC block of the complete track shall be retained as BSGA to guarantee next track readable. If attempting to blank a track that causes generation of fourth NWA, the command shall be terminated with CHECK CONDITION status and SK/ASC/ASCQ shall be set to ILLEGAL REQUEST/NO MORE TRACK RESERVATIONS ALLOWED. The LBA specified shall be the first user data block of an ECC block and shall be an existing linking block of a track. If the start address sector is not a linking block, the command shall be terminated with CHECK CONDITION status and SK/ASC/ASCQ shall be set to ILLEGAL REQUEST/INVALID ADDRESS FOR WRITE.
101b	Unclose the last complete session	This blanking type is valid for only a incrementally recorded track. If the disc is blank or the last session is not empty and not closed, then this command shall be terminated with GOOD status. If the last session is empty or if the disc is finalized, the Lead-in and Lead-out of the last complete session shall be blanked.
110b	Blank Session	If the last session is complete, its Lead-in/Border-in through the end of the Lead-out/Border-out shall be blanked. If the last session is incomplete state, all track(s) in the incomplete session shall be blanked. If the last session is empty state, the complete session immediately preceding the empty session shall be blanked. If the disc is blank, the command shall be terminated with GOOD status.
111b	Reserved	

6.2.3 Command Execution

If the Logical Unit is unable to write to the currently mounted medium, error reporting should follow the guidelines according to 0.

During a Blanking operation that began with the CDB IMMED bit set to one, the Logical Unit shall respond to commands as follows:

- a) In response to all commands except REQUEST SENSE, INQUIRY, GET CONFIGURATION, GET EVENT STATUS NOTIFICATION, and TEST UNIT READY, the Logical Unit shall return CHECK CONDITION status and set SK/ASC/ASCQ to NOT READY/LOGICAL UNIT NOT READY/OPERATION IN PROGRESS.
- b) In response to the TEST UNIT READY command, the Logical Unit should return CHECK CONDITION status and set SK/ASC/ASCQ to NOT READY/LOGICAL UNIT NOT READY/OPERATION IN PROGRESS. Some legacy implementations allowed for a GOOD status response to a TEST UNIT READY command. This behavior is not recommended.
- c) In response to the INQUIRY, GET CONFIGURATION, GET EVENT STATUS NOTIFICATION commands, the Logical Unit shall respond as commanded.
- d) In response to the REQUEST SENSE command, unless an error has occurred, the Logical Unit shall return a SK/ASC/ASCQ values set to NOT READY/LOGICAL UNIT NOT READY/OPERATION IN PROGRESS, with the sense key specific bytes set for progress indication.

If the Logical Unit changes to a not ready state during execution, an Operational Change Event shall be generated. When execution is completed and the state returns to ready, an Operational Change Event shall be generated. If the blanking results in one or more features changing currency, an additional Operational Change Event shall be generated.

Ready polling is should be done by repetitively issuing the READ DISC INFORMATION command.

6.2.4 Timeouts

The BLANK command belongs to timeout group 2 when IMMED is zero. The group 2 timeout value is only for Initiator information. The Logical Unit shall not time group 2 timeout commands. Execution shall continue until completion.

When the IMMED is set to one, status shall be returned within a Group 1 timeout.

6.2.5 Error Reporting

When the command operation began with the CDB IMMED bit set to one, it is possible that a deferred error may be reported in some future command.

Recommended error reporting is defined in Table 221.

Table 221 – Recommended errors for BLANK Command

Error	Reference	May be Deferred
Unit Attention conditions	Table F.1	
CDB or parameter list validation errors	Table F.2	
Readiness errors	Table F.3	
General media access errors	Table F.5	√
Write errors	Table F.7	√
Hardware failures	Table F.8	√

6.3 CLOSE TRACK/SESSION Command

6.3.1 Introduction

The CLOSE TRACK/SESSION command allows closure of either a track or a session. The features associated with this command are shown in Table 222.

Table 222 – Features Associated with the CLOSE TRACK/SESSION command

Feature Number	Feature Name	Command Requirement
0021h	Incremental Streaming Writable	Mandatory
0028h	MRW	Mandatory (when Write bit is one)
002Ah	DVD+RW	Mandatory (when Write bit is one)
002Bh	DVD+R	Mandatory (when Write bit is one)
002Dh	CD Track At Once	Mandatory

NOTE 1: The command requirement is valid only when the feature is current.

6.3.2 The CDB and its Parameters

6.3.2.1 The CDB

The CLOSE TRACK/SESSION CDB is shown in Table 223.

Table 223 – CLOSE TRACK/SESSION CDB

Bit	7	6	5	4	3	2	1	0
0	Operation Code (5Bh)							
1	Reserved							IMMED
2	Reserved					Close Function		
3	Reserved							
4	(MSB) Track Number (LSB)							
5								
6	Reserved							
7	Reserved							
8	Reserved							
9	Control Byte							

6.3.2.2 IMMED

The IMMED bit allows execution of the close function as an immediate operation. If IMMED is zero, then the requested close operation is processed to completion prior to returning status. If IMMED is one, then status is returned once the close operation has begun.

6.3.2.3 Close Functions

The Close Functions are given in Table 224. If the Close Function is reserved for the currently mounted medium the command shall be terminated with CHECK CONDITION status and SK/ASC/ASCQ values shall be set to ILLEGAL REQUEST/INVALID FIELD IN CDB.

6.3.2.4 Track Number

Track Number meanings are defined within the specific Close Function cases listed in Table 224. MRW format shall have precedence over physical media type.

Table 224 – Close Function Definitions

Close Function	Media/ Format	Description
000b	Stop a background format. Structuring for read compatibility is not required.	
	DD/CD-R/RW	Reserved
	DVD-R/-RW	Reserved
	DVD+RW	Optional behavior for DVD+RW media is defined. If a background format is in progress and de-icing is not completed, the format de-icing operation shall be stopped at some DVD+RW ECC block boundary. No further writing shall occur. If the medium mounted is DVD+RW and there is no background format in progress, then no operation shall occur and this shall not be considered an error. In this case, the Logical Unit shall support FDCB bit maps.
	DVD+R	Reserved
	MRW	Reserved
001b	Close the track associated with the track number in the CDB	
	DD/CD-R/RW	If this is the incomplete track, the Logical Unit shall pad with all zero main data to the minimum length of 4 seconds. No other padding shall be done. If this is a partially recorded or empty reserved track, the Logical Unit shall pad until the end of the track. In the case of an empty track, the Logical Unit shall write the track according to the Write Parameters Page. If the Write Parameters Page is inconsistent with the PMA, CHECK CONDITION status shall be returned and SK/ASC/ASCQ shall be set to ILLEGAL REQUEST/ILLEGAL MODE FOR THIS TRACK. For a partially recorded reserved track, the Logical Unit shall continue writing in the same mode as the data already recorded.
	DVD-R/-RW	If this is the Partially Recorded Reserved Track or the Empty Reserved Track, the Logical Unit shall pad the Track with 00h bytes. If the Track status is Invisible, no close operation is to be done. In the case of an Incomplete Track, no padding is to be done and cached RMD shall be written into the RMA.
	DVD+RW	Reserved
	DVD+R	If the current track is reserved and blank or partially written, the Logical Unit shall pad the track to its defined length. User data areas in all pad sectors shall be zero filled. If the track being closed is the incomplete track and the incomplete track is not blank, then a new Session DCB shall be appended into the Session Identification Zone defining the existence of the track. If the track being closed is the incomplete track and the incomplete track is blank, then the command shall be terminated with GOOD status and sense data shall be set to NO SENSE/NO ADDITIONAL INFORMATION.
	MRW	Reserved

Table 224 (continued) – Close Function Definitions

Close Function	Media/Format	Description
010b	Close the last incomplete session or stop a background format and structure for read compatibility	
	DD/CD-R/RW	Close the last session. If some track in the last Session is open, terminate the command with CHECK CONDITION status and set SK/ASC/ASCQ values to ILLEGAL REQUEST/SESSION FIXATION ERROR – INCOMPLETE TRACK IN SESSION. Behavior of the closing operation is dependent on the Multi-Session field in the Write Parameters Page (05h). If the last session is empty, the command shall be terminated with GOOD status.
	DVD-R/-RW	When the last session is in the intermediate state, Lead-in and/or Border-out are recorded to make the session complete. (if the session is to be closed that is the first one, Lead-in and Border-out shall be recorded. If the session is to be closed that is second or later one, only the Border-out shall be recorded.)
	DVD+RW	If a background format is in progress, the format operation shall be stopped and the disc shall be structured for removal according to the <i>DVD+RW 4,7 Gbytes Basic Format Specifications</i> for the specific purpose of providing DVD-RO compatibility. In general, this means that a [partial] lead-in shall be written, a [temporary] lead-out shall be appended and all unrecorded gaps between lead-in and lead-out shall be format written. The radius difference between the start of the temporary lead-out and the end of the temporary lead-out shall approximate 1 mm. The data zone shall be expanded to ensure that the total recorded area reaches at least a radius of 30 mm.
	DVD+R	Close the last session. If not all Tracks in the last Session are closed, the DVD+R Logical Unit shall terminate this command with CHECK CONDITION Status and sense data shall be set to ILLEGAL REQUEST/SESSION FIXATION ERROR/ INCOMPLETE TRACK IN SESSION. Without closing the session, determine the number of ECC blocks remaining if the session is closed. If that number is less than 65, the disc shall be finalized. Otherwise, the session should be closed. If the session being closed is session number 154, when the close session is requested, the Logical Unit shall instead finalize the disc.
	MRW	If no background is in progress, the command shall be terminated with GOOD status. If a background format is in progress, the format operation shall be stopped and the disc shall be structured for removal. For CD-RW media, the <i>CD-MRW Defect Management & Physical Formatting Specification</i> , defines the structuring. For DVD+RW media, the <i>DVD+MRW Defect Management & Physical Formatting Specification</i> defines the structuring.
011b	Special case close session	
	DD/CD-R/RW	Reserved
	DVD-R/-RW	If the disc is in restricted overwrite mode and the last session is complete state and Lead-out is not written, Lead-out shall be appended after the last Border-out. If the last session is intermediate state, Border-out and Lead-out is recorded. If the disc is not formatted, the Logical Unit shall report CHECK CONDITION status and set SK/ASC/ASCQ values to ILLEGAL REQUEST/INVALID FIELD IN CDB. For all other media this condition is Reserved, not valid.
	DVD+RW	If a background format is in progress, the format operation shall be stopped and the disc shall be structured for removal according to the <i>DVD+RW 4,7 Gbytes Basic Format Specifications</i> for the specific purpose of providing DVD-RO compatibility. In general, this means that a [partial] lead-in shall be written, a [temporary] lead-out shall be appended and all unrecorded gaps between lead-in and lead-out shall be format written. The radius difference between the start of the temporary lead-out and the end of the temporary lead-out shall approximate 1 mm.
	DVD+R	Reserved
	MRW	Reserved

Table 224 (continued) – Close Function Definitions

Close Function	Media/Format	Description
100b		Reserved Close Function code
101b		Close Last Session and Finalize the Disc – special case
	DD/CD-R/RW	Reserved
	DVD-R/-RW	Reserved
	DVD+R	Close the last session and finalize the disc. Once this close function has been processed, no more writing to the disc is allowed. If not all Tracks in the last Session are closed, the DVD+R Logical Unit shall terminate this command with CHECK CONDITION Status and sense data shall be set to ILLEGAL REQUEST/SESSION FIXATION ERROR/ INCOMPLETE TRACK IN SESSION. In order to assure maximum interchange compatibility with read only devices, Guard Zone 2 shall be recorded to a device defined PSN that approximates a disc radius of 30 mm. Suggested value: 70DE0h (462 304).
	MRW	Reserved
110b		Close Last Session and Finalize the Disc
	DD/CD-R/RW	Reserved
	DVD-R/-RW	Reserved
	DVD+RW	Reserved
	DVD+R	Close the last session and finalize the disc. Once this close function has been processed, no more writing to the disc is allowed. If not all Tracks in the last Session are closed, the DVD+R Logical Unit shall terminate this command with CHECK CONDITION Status and sense data shall be set to ILLEGAL REQUEST/SESSION FIXATION ERROR/ INCOMPLETE TRACK IN SESSION.
	MRW	Reserved
111b		Reserved Close Function code

6.3.3 Command Execution

If the Logical Unit is unable to write to the currently mounted medium, error reporting should follow the guidelines according to 0.

During a Close Track/Session operation that began with the IMMED bit set to one, the Logical Unit shall respond to commands as follows:

- a) In response to all commands except REQUEST SENSE, INQUIRY, GET CONFIGURATION, GET EVENT STATUS NOTIFICATION, and TEST UNIT READY, the Logical Unit shall return CHECK CONDITION status and set SK/ASC/ASCQ to NOT READY/LOGICAL UNIT NOT READY/OPERATION IN PROGRESS.
- b) In response to the TEST UNIT READY command, the Logical Unit should return CHECK CONDITION status and set SK/ASC/ASCQ to NOT READY/LOGICAL UNIT NOT READY/OPERATION IN PROGRESS. Some legacy implementations allowed for a GOOD status response to a TEST UNIT READY command. This behavior is not recommended.
- c) In response to the INQUIRY, GET CONFIGURATION, GET EVENT STATUS NOTIFICATION commands, the Logical Unit shall respond as commanded.
- d) In response to the REQUEST SENSE command, unless an error has occurred, the Logical Unit shall return with SK/ASC/ASCQ values set to NOT READY/LOGICAL UNIT NOT READY/LONG WRITE IN PROGRESS or NOT READY/LOGICAL UNIT NOT READY/OPERATION IN PROGRESS, with the sense key specific bytes set for progress indication.

If the Logical Unit changes to a not ready state during execution, an Operational Change Event shall be generated. When execution is completed and the state returns to ready, an Operational Change Event shall be generated. If the Closing a Track or Session results in one or more features changing currency, an additional Operational Change Event shall be generated.

6.3.4 Timeouts

The CLOSE TRACK SESSION command belongs to timeout group 2 when IMMED is zero. The group 2 timeout value is only for Initiator information. The Logical Unit shall not time group 2 timeout commands. Execution shall continue until completion.

When the IMMED is set to one, status shall be returned within a Group 1 timeout.

6.3.5 Error Reporting

When the command operation began with the CDB IMMED bit set to one, it is possible that a deferred error may be reported in some future command.

Recommended error reporting is defined in Table 225.

Table 225 – Recommended errors for CLOSE TRACK/SESSION Command

Error	Reference	May be Deferred
Unit Attention conditions	Table F.1	
CDB or parameter list validation errors	Table F.2	
Readiness errors	Table F.3	
Protocol errors	Table F.4	
General media access errors	Table F.5	√
Write errors	Table F.7	√
Hardware failures	Table F.8	√

6.4 ERASE (10) Command

6.4.1 Introduction

The ERASE (10) command requests that the Logical Unit erase the specified number of blocks starting at the specified logical block address on the medium. The features associated with this command are shown in Table 226.

Table 226 – Features Associated with the ERASE (10) Command

Feature Number	Feature Name	Command Requirement
0022h	Sector Erasable	Mandatory
NOTE 1: The command requirement is valid only when the feature is current.		

6.4.2 The CDB and its Parameters

6.4.2.1 The CDB

The ERASE (10) CDB is shown in Table 227.

Table 227 – ERASE (10) CDB

Byte	Bit	7	6	5	4	3	2	1	0
0		Operation Code (2Ch)							
1		Reserved					ERA	IMMED	RelAdr
2	(MSB)	Logical Block Address							
3									
4									
5									
6		Reserved							
7	(MSB)	Number of Blocks							
8									
9		Control							

6.4.2.2 ERA

An ERA bit (Erase All) of one indicates that all remaining blocks on the medium shall be erased. If ERA is one and the number of blocks is not zero, the command shall be terminated with CHECK CONDITION status and SK/ASC/ASCQ shall be set to ILLEGAL REQUEST/INVALID FIELD IN CDB.

6.4.2.3 IMMED

If IMMED is zero, then the requested operation is processed to completion prior to returning status. If IMMED is one, then status is returned once the operation has begun.

6.4.2.4 RelAdr

Multi-media devices do not support relative addressing. RelAdr shall be set to zero. If RelAdr is set to one, the command shall be terminated with CHECK CONDITION status and SK/ASC/ASCQ shall be set to ILLEGAL REQUEST/INVALID FIELD IN CDB.

6.4.2.5 Logical Block Address

The Logical Block Address field contains the LBA at which erase operations shall begin.

6.4.2.6 Number of Blocks

Number of Blocks specifies the number of contiguous logical blocks that shall be erased when ERA is zero. If ERA is zero, a Number of Blocks of zero indicates that no blocks shall be erased. This condition shall not be considered an error and no data shall be erased. Any other value indicates the

number of logical blocks that shall be erased.

6.4.3 Command Execution

As used here, erased means either the medium shall be erased, or a pattern shall be written on the medium that appears to the Logical Unit as no data present. The blocks erased shall be considered blank for purposes of blank checking. Previous data recorded on the medium, if any, shall not be recoverable.

If the Logical Unit is unable to write to the currently mounted medium, error reporting should follow the guidelines according to 0.

During an Erasing operation that began with the IMMED bit set to one, the Logical Unit shall respond to commands as follows:

- e) In response to all commands except REQUEST SENSE, INQUIRY, GET CONFIGURATION, and GET EVENT STATUS NOTIFICATION, the Logical Unit shall return CHECK CONDITION status and set SK/ASC/ASCQ to NOT READY/LOGICAL UNIT NOT READY/OPERATION IN PROGRESS.
- f) In response to the INQUIRY, GET CONFIGURATION, GET EVENT STATUS NOTIFICATION commands, the Logical Unit shall respond as commanded.
- g) In response to the REQUEST SENSE command, unless an error has occurred, the Logical Unit shall return a SK/ASC/ASCQ values set to NOT READY/LOGICAL UNIT NOT READY/OPERATION IN PROGRESS, with the sense key specific bytes set for progress indication.

If the Logical Unit changes to a not ready state during execution, an Operational Change Event shall be generated. When execution is completed and the state returns to ready, an Operational Change Event shall be generated.

6.4.4 Timeouts

The ERASE command belongs to timeout group 1. When the IMMED bit in the CDB is set to one, timeouts are not permitted. Otherwise, if the command is terminated with CHECK CONDITION status due to a timeout, sense bytes SK/ASC/ASCQ shall be set to NOT READY/INSUFFICIENT TIME FOR OPERATION.

6.4.5 Error Reporting

When the command operation began with the CDB IMMED bit set to one, it is possible that a deferred error may be reported in some future command.

Recommended error reporting is defined in Table 228.

Table 228 – Recommended errors for ERASE (10) Command

Error	Reference	May be Deferred
Unit Attention conditions	Table F.1	
CDB or parameter list validation errors	Table F.2	
Readiness errors	Table F.3	
General media access errors	Table F.5	√
Write errors	Table F.7	√
Hardware failures	Table F.8	√

6.5 FORMAT UNIT Command

6.5.1 Introduction

The FORMAT UNIT command formats a medium into Initiator addressable logical blocks according to Initiator defined options. The medium may be certified and control structures created for the management of the medium and defects. The medium may or may not be altered.

In order to fully support random reading and/or random writing, many types of rewritable media shall be fully written (formatted). This is the case for CD-RW, DDCD-RW, DVD-RW, and DVD+RW. Based upon media and device types, full format time may be unreasonably high. This may be mitigated by use of the IMMED bit in the Format Unit Parameter List or with Background Formatting.

The features associated with this command are shown in Table 229.

Table 229 – Features Associated with the FORMAT UNIT Command

Feature Number	Feature Name	Command Requirement
0023h	Formattable	Mandatory
0028h	MRW	Mandatory when the Write bit is one
002Ah	DVD+RW Basic Format	Mandatory when the Write bit is one

NOTE 1: The command requirement is valid only when the feature is current.

6.5.2 The CDB and Its Parameters

6.5.2.1 The CDB

The FORMAT UNIT CDB is shown in Table 230.

Table 230 – FORMAT UNIT CDB

Bit	7	6	5	4	3	2	1	0
Byte								
0	Operation Code (04h)							
1	Reserved			FmtData	CmpList	Format Code		
2	Reserved							
3	(MSB) Interleave Value (LSB)							
4								
5	Control Byte							

6.5.2.2 FmtData

If the FmtData bit is zero, there is no parameter list. If FmtData is one, a parameter list is available from the Initiator. For all Multi-media Logical Units, FmtData shall be set to one. If FmtData is zero, the command shall be terminated with CHECK CONDITION status and SK/ASC/ASCQ shall be set to ILLEGAL REQUEST/INVALID FIELD IN CDB.

6.5.2.3 CmpList

The CmpList bit is used in conjunction with the DCRT (Disable Certification) bit to determine usage of the existing G1-list, G2-list and SDL to construct new G1-list and G2-list (Table 231) on DVD-RAM media. A CmpList bit of zero indicates that the parameter list provided is in addition to those already available to the Logical Unit. A CmpList bit of one indicates that the parameter list is complete and the Logical Unit is to ignore any existing parameters. This is specific to DVD-RAM and is different from the generic implementation described in SBC.

On CD-RW, DDCD-RW, DVD-RW, DVD+RW media and MRW formats, CmpList bit shall be set to zero.

Table 231 – DVD-RAM Defect List Handling

CmpList	DCRT	Certification	PDL			SDL	Remarks
			P-list	G1-list	G2-list		
0	0	Yes	Preserved	New from Certification	Disposed	Disposed	Slow initialization
0	1	No	Preserved	Preserved	Old + New from SDL	Disposed	Change linear replacement to slipping, quickly
1	0	Yes (Partial) Obsolete	Preserved	Old plus New from Certification	Disposed	Disposed	Create new defect list by disposing all except P-list and G1-list
1	1	No	Preserved	Preserved	Disposed	Disposed	Return to original slipping at the latest certification, quickly

6.5.2.4 Format Code

The Format Code identifies the parameter list format. The Format Code shall be set to one (001b). The Format Code seven (111b) has a legacy definition for CD-RW and DDCD-RW. See Annex E.

6.5.2.5 Interleave Value

The Interleave Value field identifies the value to be used when formatting. Interleave Value shall be zero.

6.5.3 Format Parameter List

6.5.3.1 List Format

The FORMAT UNIT parameter list (Table 232) consists of three descriptors: the Format List Header, the Initialization Pattern Descriptor, and the Format Descriptor.

Table 232 – Format Unit Parameter List

Bit	7	6	5	4	3	2	1	0
Byte								
0 – 3	Format List Header							
4 – n	Initialization Pattern Descriptor (present if IP = 1)							
n+1 to n+8	Format Descriptor							

6.5.3.2 Format List Header

The Format List Header (Table 233) provides several format control bits. Logical Units that implement these bits give Initiators additional control over the formatting operation. If the Initiator attempts to select any function not implemented by the Logical Unit, the Logical Unit shall terminate the command with CHECK CONDITION status and SK/ASC/ASCQ values shall be set to ILLEGAL REQUEST/INVALID FIELD IN PARAMETER LIST.

Table 233 – Format List Header

Bit	7	6	5	4	3	2	1	0
Byte								
0	Reserved							
1	FOV	DPRY	DCRT	STPF	IP	Try-out	IMMED	VS
2	Format Descriptor Length							
3								

If the Format Options Valid (FOV) bit is zero, the Logical Unit shall use its default settings for the

values of DPROY, DCRT, STPF, IP, and Try-out. When the FOV bit is zero, the Initiator should set these bits to zero. If any of these bits are not zero, the Logical Unit shall terminate the command with CHECK CONDITION status and set SK/ASC/ASCQ values to ILLEGAL REQUEST/INVALID FIELD IN PARAMETER LIST. If FOV is one, the Logical Unit shall examine the setting of the DPROY, DCRT, STPF, IP, and Try-out.

The DPROY, DCRT, STPF, IP, and Try-out, IMMED, and VS bits are defined as follows:

- a) When Disable Primary (DPROY) bit is set to zero, the Logical Unit shall not use portions of the medium identified as defective in the primary defect list (PLIST) for Initiator addressed logical blocks. When DPROY is set to one, the Logical Unit shall not use the PLIST to identify defective areas of the medium. The PLIST shall not be deleted. DPROY may be set to one for DVD-RAM media. DPROY shall be set to zero when the currently mounted medium is CD-RW, DDCD-RW, DVD-RW, or DVD+RW. If DPROY is set to one, and the currently mounted medium is CD-RW, DDCD-RW, DVD-RW, or DVD+RW, the Logical Unit shall terminate the command with CHECK CONDITION status and SK/ASC/ASCQ values shall be set to ILLEGAL REQUEST/INVALID FIELD IN PARAMETER LIST.
- b) If the Disable Certification (DCRT) bit is set to zero, the Logical Unit shall perform a vendor-specific medium certification operation. A DCRT bit of one indicates that the Logical Unit shall not perform the vendor-specific medium certification process or format verification operation while executing the FORMAT UNIT command.
- c) The STPF bit is reserved. If STPF is not zero, the Logical Unit shall terminate the command with CHECK CONDITION status and set SK/ASC/ASCQ values to ILLEGAL REQUEST/INVALID FIELD IN PARAMETER LIST.
- d) If the Initialization Pattern (IP) bit is set to zero, an initialization pattern descriptor is not included and that the Logical Unit shall use its default initialization pattern. If IP is set to one, an initialization pattern descriptor is sent to the Logical Unit as part of the FORMAT UNIT Parameter List. For CD-RW media and DVD+RW media, the IP bit is reserved and shall be set to zero. If the currently mounted medium is either CD-RW or DVD+RW and IP is set to one, the command shall be terminated with CHECK CONDITION status and SK/ASC/ASCQ values shall be set to ILLEGAL REQUEST/INVALID FIELD IN PARAMETER LIST.
- e) When the Try-out bit is set to zero, the Logical Unit shall perform whatever format writing is required. When the Try-out bit is set to one, the Logical Unit shall use available information to determine the possibility of formatting the media according to the parameter list provided. The Logical Unit shall not write to the media. If formatting is possible, then the command shall be terminated with GOOD status. If the Logical Unit determines that error free formatting is not possible, the command shall be terminated with CHECK CONDITION status and SK/ASC/ASCQ values shall be set to MEDIUM ERROR/MEDIUM FORMAT CORRUPTED. For CD-RW and DVD+RW media, the Try-out bit is reserved and shall be set to zero. If the currently mounted medium is either CD-RW or DVD+RW and Try-out is set to one, the command shall be terminated with CHECK CONDITION status and SK/ASC/ASCQ values shall be set to ILLEGAL REQUEST/INVALID FIELD IN PARAMETER LIST..
- f) If the immediate (IMMED) bit is zero, status shall be returned only after the format operation has completed. If the IMMED bit is set to one, the Logical Unit shall return status as soon as the CDB and the Format Descriptor have been validated and the format process has begun.
- g) The Vendor Specific (VS) bit has a vendor-specific definition.

The Format Descriptor Length field in the Format list header specifies the total length in bytes of the Format descriptors that follow and does not include the initialization pattern descriptor or initialization pattern, if any.

The Format Descriptor Length shall be set to 8. If any other value is found in this field, the Logical Unit shall terminate the command with CHECK CONDITION status and SK/ASC/ASCQ values shall be set to ILLEGAL REQUEST/INVALID FIELD IN PARAMETER LIST.

6.5.3.3 Initialization Pattern

If the IP bit in the Format List Header is set to one, the initialization pattern descriptor (Table 234) is included as part of the FORMAT UNIT parameter list.

Table 234 – Initialization Pattern Descriptor

Bit	7	6	5	4	3	2	1	0
Byte								
0	IP Modifier		SI	Reserved				
1	Pattern Type							
2	(MSB) Initialization Pattern Length (LSB)							
3								
4	Initialization Pattern							
:								
n								

The IP Modifier field specifies the type and location of a header that modifies the initialization pattern (see Table 235).

Table 235 – IP Modifier Field

IP Modifier	Descriptor
00b	No header. The Logical Unit shall not modify the initialization pattern.
01b	The Logical Unit shall overwrite the initialization pattern to write the logical block address in the first four bytes of the logical block. The LBA shall be written with the most significant byte first.
10b	The Logical Unit shall overwrite the initialization pattern to write the logical block address in the first four bytes of each physical block contained within the logical block. The lowest numbered logical block or part there of which occurs within the physical block is used. The LBA shall be written with the most significant byte first.
11b	Reserved

The Pattern Type field (Table 236) indicates the type of pattern the Logical Unit shall use to initialize each logical block within the Initiator accessible portion of the medium. All bytes within a logical block shall be written with the initialization pattern. The IP Modifier field modifies the Initialization Pattern.

Table 236 – Initialization Pattern Type

Initialization Pattern Type	Description
00h	Use default pattern. If the initialization pattern length is not zero the Logical Unit shall terminate the command with CHECK CONDITION status and SK/ASC/ASCQ shall be set to ILLEGAL REQUEST/INVALID FIELD IN PARAMETER LIST.
01h	Repeat the initialization pattern as required to fill the logical block. If the initialization pattern length is zero the Logical Unit shall terminate the command with CHECK CONDITION status and SK/ASC/ASCQ shall be set to ILLEGAL REQUEST/INVALID FIELD IN PARAMETER LIST.
02h – 7Fh	Reserved
80h – FFh	Vendor Specific

If the SI bit is zero, the Logical Unit shall initialize the Initiator accessible area of the media. The Logical Unit is not required to initialize other areas of the media, however the Logical Unit shall format the medium as defined in the FORMAT UNIT command.

If the Security Initialize (SI) bit is set to one the Logical Unit shall attempt to write the initialization pattern to all areas of the media including those that may have been reassigned. The initialization pattern shall be written using a security erasure write technique. Initiators may choose to use this command multiple times to fully erase the previous data. Such security erasure write technique

procedures are outside the scope of this standard. The exact requirements placed on the security erasure write techniques are vendor-specific. The intent of the security erasure write is to render any previous user data unrecoverable by any analog or digital technique. The Logical Unit is not required to write (format) header and other information not previously accessible to the Initiator. If any area of the medium that previously was accessible to the Initiator is unable to be written, the Logical Unit shall terminate the command with CHECK CONDITION status and the sense key shall be set to MEDIUM ERROR with the appropriate ASC for the condition.

The Initialization Pattern Length field indicates the number of bytes contained in the initialization pattern.

If the length exceeds the current logical block size the Logical Unit shall terminate the command with CHECK CONDITION status and SK/ASC/ASCQ values shall be set to ILLEGAL REQUEST/INVALID FIELD IN PARAMETER LIST.

6.5.3.4 Format Descriptor

When the the currently mounted media is CD-RW or DDCD-RW and the CDB Format Code is 111b, a legacy Format Descriptor for may be appended. See Annex E.

When the CDB Format Code is 001b, a Format Descriptor is included in the FORMAT UNIT Parameter List. The Format Descriptor (Table 237) is an eight-byte entry.

Table 237 – Format Code 001b Format Descriptor

Byte	Bit	7	6	5	4	3	2	1	0	
0	(MSB)	Number of Blocks							(LSB)	
1										
2										
3										
4		Format Type					Reserved			
5	(MSB)	Type Dependent Parameter							(LSB)	
6										
7										

The Format Type field specifies the type of formatting. Contents of the Number of Blocks field and the Type Dependent Parameter field depend on Format Type.

6.5.3.4.1 Format Type = 00h (Full Format)

Formatting for the entire media is specified. Except as specified, the Number of Blocks field specifies the number of addressable blocks for the entire disc and the Type Dependent Parameter field specifies the Block Length.

For CD-RW media, the entire media shall be formatted using Write Parameter Mode Page information.

For DVD-RAM media, the defect list handling is specified by the combination of the CmpList bit and the DCRT bit as shown in Table 231. In the case that the CmpList bit is set to zero and the DCRT bit is set to one, the Number of Blocks field shall be ignored and the number of addressable blocks shall be retained. Otherwise, the Number of Blocks field specifies the number of addressable blocks for the whole disc. For DVD-RAM the Number of Blocks value shall be the value returned by the READ FORMAT CAPACITIES command. The Type Dependent Parameter field specifies the Block Length.

On DVD-RW media, this format operation is always available. The area from the beginning of the RMA to the end of the Lead-out shall be recorded. There is only one session on the medium and the number of track is one after this operation. The Disc Status field of Format 3 RMD shall be set to 12h when the operation is completed.

6.5.3.4.2 Format Type = 01h (Spare Area Expansion)

This Format Type is defined only for DVD-RAM media.

In order to keep more Spare area, this formatting is used. Eventually the capacity of the formatted area is reduced. Therefore, this formatting type is just available with the case of reduction of formatted capacity.

The Logical Unit shall ignore the defect list handling specified by the combination of the CmpList bit and the DCRT bit. The defect list entries and the written user data within the range of the area that is specified by this command shall be preserved through the execution of this command. The number of Blocks field specifies the number of addressable blocks for the whole disc and the Type Dependent Parameter field specifies the Block Length. Neither field is changeable from the values reported by the READ FORMAT CAPACITIES command (6.28).

6.5.3.4.3 Format Type = 04h (Zone Reformat)

The Zoned formatting for a zone of the media is specified where the size of zone is not constant across zones. The defect list handling is specified by the combination of the CmpList bit and the DCRT bit as shown in Table 231. The Number of Blocks field specifies the number of addressable blocks for the zone and the Type Dependent Parameter field specifies the Zone number of the zone to be formatted. If a spare sector is used as a replacement for another zone so that the zoned formatting is unable to be preformed, the command shall be terminated with a CHECK CONDITION status, SK/ASC/ASCQ values shall be set to MEDIUM ERROR/ZONED FORMATTING FAILED DUE TO SPARE LINKING, and the sense key specific bytes set to zone number of the first zone that has a spare linking into the designated zone.

The discarding of G1-list, G2-list, and SDL is only applicable to defects within the zone being reformatted.

6.5.3.4.4 Format Type = 05h (Zone Format)

This Format Type is defined only for DVD-RAM media.

The Zoned formatting for a zone of the media is specified where the size of zone is constant for each zone, e.g. floppy media where each track is labeled a zone. The Number of Blocks field specifies the number of addressable blocks for the zone and the Type Dependent Parameter field specifies the Zone number of the zone to be formatted. The zone number shall be in the range of 0 to the Type Dependent Parameter reported in READ FORMAT CAPACITIES command (6.28).

6.5.3.4.5 Format Type = 10h (CD/DVD-RW Full Format)

Formatting to create a session on CD/DVD-RW media is specified. The created session shall become the only session on the medium. The Number of Blocks field specifies the number of addressable blocks for the new session and the Type Dependent Parameter field specifies the Fixed

Packet Size for CD or set to ECC block size (16) for DVD-RW. The number of blocks field may be adjusted to a value less than or equal to the values reported by the READ FORMAT CAPACITIES command (6.28). The Logical Unit shall round the Number of Blocks up to be an integral multiple of the packet size for CD or set to ECC block size (16) for DVD-RW. The Packet Size field shall not be adjusted. In the case of CD media, if a different Fixed Packet Size is desired, the Initiator should modify the Write Parameters Page.

On DVD-RW media, this format operation is always available. The track number in the created session is one after this operation. The Disc Status field of Format 3 RMD shall be set to 12h when the operation is completed.

6.5.3.4.6 Format Type = 11h (CD/DVD-RW Grow Session)

In the case of CD-RW, formatting to expand the last session is specified. The Number of Blocks field specifies the number of addressable blocks to be enlarged and the Type Dependent Parameter field specifies the Packet Length. The Number of Blocks field may be adjusted to a value greater than the existing Session size and less than or equal to the values reported by the READ FORMAT CAPACITIES command. The Logical Unit shall round the Number of Blocks up to be an integral multiple of the packet size. The Packet Size field shall not be adjusted.

In the case of DVD-RW, formatting to expand the last session and enter the last session program area into intermediate state is specified. The Number of Blocks field specifies the number of addressable blocks to be added to current session capacity and the Type Dependent Parameter field is set to ECC block size (16). The Logical Unit shall round the Number of Blocks up to be an integral multiple of the ECC block size.

This format operation is available only when a disc is in restricted overwrite mode and the last session is in a complete state. Growing of session operation shall start from the next sector of End Sector Number of Track #n field that is corresponded to the last track. End PSN of Data Area and Start PSN of the current Lead-out/Border-out field of Lead-in/Border-in shall be changed to reflect the expanded session. The number of sessions and tracks does not change after this operation.

6.5.3.4.7 Format Type = 12h (CD/DVD-RW Add Session)

Formatting to add a new session to a CD/DVD-RW media is specified. The Number of Blocks field specifies the number of addressable blocks for the new session and the Type Dependent Parameter field specifies the Fixed Packet Size for CD or is set to ECC block size (16) for DVD-RW. The Number of Blocks field may be adjusted to a value less than or equal to the values reported by the READ FORMAT CAPACITIES Command (6.28).

The Logical Unit shall round the Number of Blocks up to be an integral multiple of the packet size for CD or the ECC block size for DVD. The Packet Size field shall not be adjusted. On CD media, if a different Fixed Packet Size is desired, the Initiator should modify the Write Parameters Page.

On DVD-RW media, this format operation is available only when a disc is in restricted overwrite mode and the last session is in a complete state. Start PSN of the next Border-in field in the previous Border-in/Lead-in shall be updated.

6.5.3.4.8 Format Type = 13h (DVD-RW Quick Grow the last Session)

Formatting to expand the last session and enter the last session into intermediate state of a DVD-RW medium is specified. The Number of Blocks field specifies the number of addressable blocks to be added to current session capacity and the Type Dependent Parameter field is set to ECC block size (16). The Logical Unit shall round the Number of Blocks up to be an integral multiple of the ECC block size.

This format operation is available only when the disc is in restricted overwrite mode and the last session is complete state. Growing of session operation shall start from the next sector of End Sector Number of Track #n field that is corresponded to the last track.

The number of sessions and tracks does not change after this operation. The Disc Status field of Format 3 RMD shall be set to 13h when the operation is completed. End PSN of Data Area field in Lead-in/Border-in of the last session shall be set to 30000h. And Start PSN of the current Border-out and Start PSN of the next Border-in field in Lead-in/Border-in of the last session shall be set to 00h.

6.5.3.4.9 Format Type = 14h (DVD-RW Quick Add Session)

Formatting to add a new intermediate state session to an existing session on DVD-RW media is specified. At least one or more sessions shall exist on a medium and the last session shall not be intermediate state before start this operation.

The area from the beginning of Border-in that follows the last Border-out, user data blocks and 32 ECC blocks with Lead-out attribute is recorded. Start PSN of the next Border-in field in the previous Border-in/Lead-in shall not be changed to reflect the intermediate state session that is added.

If FORMAT UNIT command with this Format Type is issued when the last session is already intermediate state, the command shall be terminated with CHECK CONDITION status and SK/ASC/ASCQ values shall be set to ILLEGAL REQUEST/INVALID FIELD IN PARAMETER LIST.

The Number of Blocks field specifies the number of addressable blocks for the new session and the Type Dependent Parameter field is set to ECC block size (16). The Number of Blocks field may be adjusted to a value less than or equal to the values reported by the READ FORMAT CAPACITIES command. The Logical Unit shall round the Number of Blocks up to be an integral multiple of the ECC block size.

6.5.3.4.10 Format Type = 15h (DVD-RW Quick)

Formatting to create an Intermediate State session on DVD-RW media is specified. The created session shall become the only session on the medium. The Number of Blocks field specifies the number of addressable blocks for the new session and the Type Dependent Parameter field is set to ECC block size (16). The Number of Blocks field may be adjusted to a value less than or equal to the values reported by the READ FORMAT CAPACITIES command. The Logical Unit shall round the Number of Blocks up to be an integral multiple of the ECC block size for DVD.

This format operation is always available. If a disc is to be formatted that is blanked, new intermediate state session is created at the beginning of the disc and the recording mode is changed to restricted overwrite mode. The number of track in the created session is one after this operation. The Disc Status field of Format 3 RMD shall be set to 13h when the operation is completed.

6.5.3.4.11 Format Types = 24h, (MRW Full Format)

If the currently mounted medium is neither CD-RW nor DVD+RW, the command shall be terminated with CHECK CONDITION status and set SK/ASC/ASCQ values to ILLEGAL REQUEST/INVALID FIELD IN PARAMETER LIST.

If the currently mounted media is CD-RW and a new format is requested, the Number of Blocks parameter shall have the value FFFFFFFFh. If the field contains any other value, the Logical Unit shall terminate the command with CHECK CONDITION status and set SK/ASC/ASCQ values to ILLEGAL REQUEST/INVALID FIELD IN PARAMETER LIST.

If the currently mounted media is 8 cm DVD+RW and a new format is requested, the Number of Blocks parameter shall have the value FFFFFFFFh. If the field contains any other value, the Logical Unit shall terminate the command with CHECK CONDITION status and set SK/ASC/ASCQ values to ILLEGAL REQUEST/INVALID FIELD IN PARAMETER LIST. Spare area 1 shall be 4 096 sectors in length while spare area 2 shall be 61 440 sectors in length. Sparing represents approximately 10% of the primary user data space.

If the currently mounted media is 12 cm DVD+RW and a new format is requested, the Number of Blocks parameter shall have either the value FFFFFFFFh or FFFF0000h. If the field contains any other value, the Logical Unit shall terminate the command with CHECK CONDITION status and set SK/ASC/ASCQ values to ILLEGAL REQUEST, INVALID FIELD IN PARAMETER LIST. Spare area 1 is always 4 096 sectors in length. When the Number of Blocks value is FFFFFFFFh, spare area 2 is 61 440 in length. In this case, sparing represents approximately 3% of the primary user data space. When the Number of Blocks value is FFFF0000h, spare area 2 is 258 048 in length. In this case, sparing represents approximately 12.8% of the primary user data space.

Formatting operates in background for Format Type 24h. The Initiator may suspend a format in progress and may restart the format.

The Type Dependent Parameter has the meaning of "New format" when it has the value 000000h. The Type Dependent Parameter has the meaning of "Restart format" when it has the value 000001h.

When Restart format is selected, the Number of Blocks field has no meaning and shall be ignored. If the field contains any other value, the Logical Unit shall terminate the command with CHECK CONDITION status and set SK/ASC/ASCQ values to ILLEGAL REQUEST/INVALID FIELD IN PARAMETER LIST.

Certification of the format is based upon current medium status as shown in Table 238.

Table 238 – Use of DCRT when MRW Formatting

Current Disc Status	DCRT = 0	DCRT = 1
Physically Blank	Write entire surface format, verify MRW structures and user areas	Write entire surface format, verify only MRW structures
Written, but not MRW Formatted (includes logically blank)	Write format, verify MRW structures and user areas. In this case, the CD-MRW Defect Management & Physical Formatting Specification and the DVD+MRW Defect Management & Physical Formatting Specification require certification of the user area.	
MRW formatted	Reinitialize MRW structures, verify MRW structures and user areas. In this case, the CD-MRW Defect Management & Physical Formatting Specification and the DVD+MRW Defect Management & Physical Formatting Specification require certification of the user area.	

In all cases when:

- DCRT is set to zero,
- the Initiator requests to WRITE the sector at LBA = N, and
- sector N has not yet been verified by the format operation,.

The WRITE command shall be treated as a WRITE and VERIFY command.

6.5.3.4.12 Format Type = 26h, (DVD+RW Basic Format)

If the currently mounted medium is not DVD+RW, the command shall be terminated with CHECK CONDITION status and set SK/ASC/ASCQ values to ILLEGAL REQUEST/INVALID FIELD IN PARAMETER LIST.

The Number of Blocks field shall be set to either the value returned by the READ FORMAT CAPACITIES command or FFFFFFFFh. The Logical Unit shall accept either value. If the Initiator sends any other value, then the Logical Unit shall terminate the command with CHECK CONDITION status and set SK/ASC/ASCQ values to ILLEGAL REQUEST/ILLEGAL VALUE IN PARAMETER BLOCK. Implementation of background format is mandatory.

Formatting operates in background for Format Type 26h. The Initiator may suspend a format in progress and may restart the format.

The Type Dependent Parameter is shown in Table 239.

Table 239 – Type Dependent Parameter for Format Type 26h

Bit	7	6	5	4	3	2	1	0
Byte								
0	Reserved							
1								
2	Reserved						Quick Start	Restart

When Quick Start is zero, the format operation shall initialize the lead-in according to x prior to declaring the format command complete. When Quick Start is one, the format operation shall not initialize the entire lead-in prior to sending GOOD status for the format command.

NOTE 12: The amount of the lead-in initialized by Quick Start formatting is vendor specific.

When Restart is set to zero, the Logical Unit shall perform a new format.

When Restart is set to one, the DVD+RW Logical Unit shall continue a suspended background

format. All other fields in the Type Dependent Parameter shall be ignored. If there is no suspended background format to continue, the DVD+RW Logical Unit shall terminate the command with CHECK CONDITION status and set sense data to ILLEGAL REQUEST, COMMAND SEQUENCE ERROR.

DCRT has no meaning when formatting type 26h. The device ignores DCRT.

6.5.4 Command Execution

6.5.4.1 Overview

If the Logical Unit is unable to write to the currently mounted medium, error reporting should follow the guidelines according to 4.1.6.3.

6.5.4.2 Use of the IMMED Bit

If the IMMED bit is set to zero, the Logical Unit shall format the entire media according to the Format Unit Parameter List and shall not terminate the command until completed. This is undesirable when the Initiator/Device interface has limited or no disconnect/reselect capability.

If the IMMED bit is set to one, the Logical Unit shall verify that execution of the Format Unit command may begin without error and then terminate the command with GOOD status.

During a format operation that began with the IMMED bit set to one, the Logical Unit shall respond to commands as follows:

- In response to all commands except REQUEST SENSE, INQUIRY, GET CONFIGURATION, and GET EVENT STATUS NOTIFICATION, the Logical Unit shall return CHECK CONDITION status and set SK/ASC/ASCQ to NOT READY/LOGICAL UNIT NOT READY/FORMAT IN PROGRESS. If the Logical Unit changes ready state, an Operational Change Event shall be generated. If appropriate, other events may be generated (e.g. Media Events).
- In response to the INQUIRY, GET CONFIGURATION, GET EVENT STATUS NOTIFICATION commands, the Logical Unit shall respond as commanded.

In response to the REQUEST SENSE command, unless an error has occurred, the Logical Unit shall return a SK/ASC/ASCQ values set to NOT READY/LOGICAL UNIT NOT READY/FORMAT IN PROGRESS, with the sense key specific bytes set for progress indication (Table 240). The normative description is found in SPC-3. SKSV shall be set to one and the Progress Indication field shall contain 16 bit unsigned value such that $(\text{Progress Indication})/65536 \times 100\%$ approximates the percentage of completion of the operation. Once the operation is completed, SKSV shall be set to zero.

Table 240 – Sense Key Specific Bytes in Sense Data

Bit	7	6	5	4	3	2	1	0
Byte								
15	SKSV	Reserved						
16	(MSB)	Progress						
17		Indication						(LSB)

6.5.4.3 Background Formatting

6.5.4.3.1 Overview

Background formatting is defined for MRW (Format Type 24h) and DVD+RW (Format Type 26h). Background Formatting is divided into 2 processes: the foreground format process, and the background format process. The foreground format process is performed first. Once the foreground process has completed, the background format process begins. Of total format time required, the foreground format process should represent a very small part, while the background format process represents a significantly larger part.

Once the background format process has begun, the Initiator may request a suspension of the format operation for the purpose of media removal. If a suspension is requested, the Logical Unit shall write to the media in such a way that the format state and level of completion may be identified for the

purpose of continuing the background format process.

During the term of the background format, its state (Completed (3), Not Complete and running (2), Not complete and not running (1)) shall be reported in the returned data of the READ DISC INFORMATION command. See Figure 47.

6.5.4.3.2 The Foreground Part of the Format Process

During the foreground format process, basic media structures shall be minimally initialized such that the media Format State may be identified. Relative to the Initiator, the operation is no different from other formatting. The foreground format process is completed when:

1. The specific format type is identifiable based upon written media structures.
2. Format restart information indicates that a suspended background format may be continued with an indication that zero amount of the background format process has been performed.

If the IMMED bit is set to zero, then once the foreground format process has completed, the command shall be terminated with GOOD status.

If the IMMED bit is set to one, the Format Unit Command should be terminated with GOOD status once the CDB and parameter list have been validated.

6.5.4.3.3 The Background Format Process

Once the foreground part of the formatting has completed, the Logical Unit shall continue the format in background. It is at this point that BG format status in the READ DISC INFORMATION returned data becomes non-zero. If the formatting had begun with IMMED = 0, the Format Unit Command shall be terminated with GOOD status. At this point, the media is viewed as "write accessible". If any media accessing command is issued before this time, the Logical Unit shall terminate the command with CHECK CONDITION status and set sense bytes SK/ASC/ASCQ to NOT READY/LOGICAL UNIT NOT READY/FORMAT IN PROGRESS.

Regardless of the setting of IMMED, once the disc has become write accessible, and there are no pending errors, sense bytes SK/ASC/ASCQ shall be set to NO SENSE/FORMAT IN PROGRESS and the sense key specific bytes (Table 240) shall be set as a progress indicator.

Warning to Implementers:

Logical Unit panel indicators (e.g. LEDs) may normally indicate writing. Implementers should choose to modify this behavior during background formatting in order to avoid confusing the user.

6.5.4.3.4 Stopping and Restarting Background Format

If a format is executing in background:

- a) The CLOSE TRACK/SESSION Command shall be used to stop the formatting process. See 6.3 for details.
- b) The inactivity timer (CD-ROM Mode Page) is disabled. This insures that lack of Initiator activity does not allow a spin down during background formatting.
- c) If the Initiator sends a SCSI command that requires that the medium spin down, the Logical Unit shall terminate the command with CHECK CONDITION status and set sense data to NOT READY, LOGICAL UNIT NOT READY, FORMAT IN PROGRESS. Examples: START/STOP UNIT command is issued with Start = 0, START/STOP UNIT command with power controls that require a spin-down.
- d) If the Initiator/Logical Unit physical interface provides a command layer with commands that may cause the medium to spin down, then those commands shall be terminated with the appropriate error status. e.g. if the interface is ATA and the command is EXECUTE DIAGNOSTICS, IDLE or SLEEP, then the command shall be terminated with the status register ERROR bit set to true.
- e) If any other command is issued to the Logical Unit, it shall be processed normally.

The format process may be restarted with a FORMAT UNIT Command in which the format descriptor is sent with the type dependent parameter set to 000001h. If the format has been completed, restarting the background format function shall not be considered an error. The command shall terminate with GOOD status and the BgformatCompleted event shall be posted.

The Logical Unit may also restart the format process automatically. If a write is requested at an

address within the final media capacity and beyond the current user formatted space, the background format shall be restarted using parameters saved on the media. The BgformatRestarted Media Event shall be posted. The format state shall be changed to "Not Complete and Running", and the write shall proceed accordingly. See clause 6.5.4.3.5.

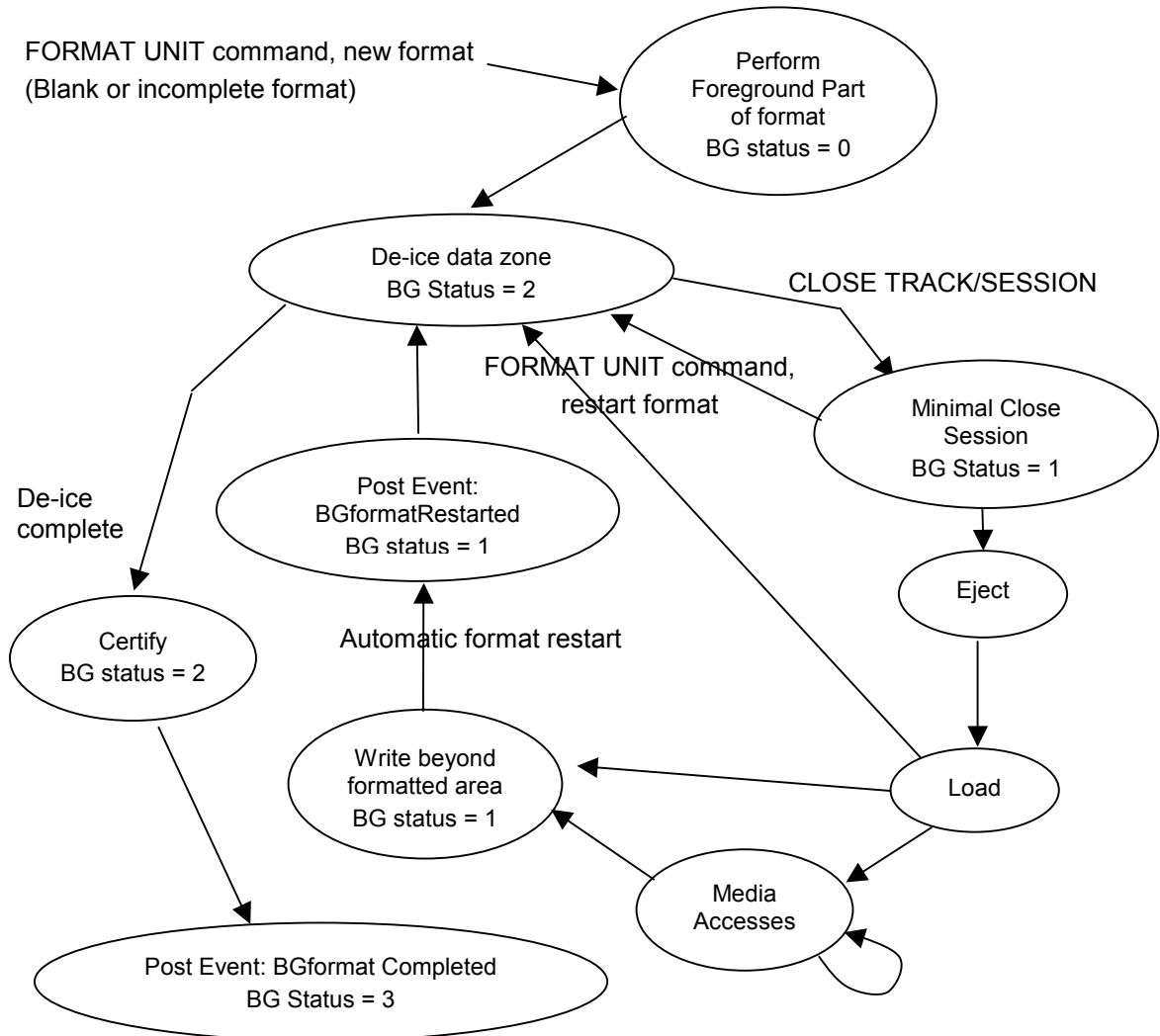

Figure 47 – Background Process Flow

6.5.4.3.5 Writing During the Background Format Process

Writing to the media during different format states sometimes requires different action by the Logical Unit. The cases are shown in Table 241.

Table 241 – Writing During different Format States

State of Format	Write Range	Action By Logical Unit
Completed	All valid user space addresses	The Initiator's data is written as provided.
Not Complete and running	All valid user space addresses	The Initiator's data is written as provided. Format state shall not be changed.
Not complete, not running	Valid user space addresses in formatted region	The Initiator's data is written as provided. Format state shall not be changed.
	Valid user space addresses beyond formatted region (This includes relocations into a spare area beyond the temporary STA. The implementer should be aware that relocations may occur during read when ARRE is set to one in the READ/WRITE ERROR RECOVERY MODE PAGE.)	The background format shall be restarted using parameters saved on the media. The BgformatRestarted Media Event shall be posted. The format state is now "Not Complete and Running", so the write shall proceed accordingly.

6.5.4.3.6 Recovering an Incomplete Format

The background format may be stopped in a controlled way as described in 6.5.4.3.4, above. An interface level RESET or loss of power may also stop a background format operation, but not in a controlled way. This may produce a disc that is partially formatted, however, it may also contain recoverable data. The format may not be recoverable, however, user data should be recoverable. After a catastrophic power loss, some use data may be lost.

An Initiator operated recovery application may be produced in order to recover data from the disc. Refer to the appropriate physical format documents.

6.5.5 Timeouts

The FORMAT UNIT command belongs to timeout group 2 when IMMED is zero. The group 2 timeout value is only for Initiator information. The Logical Unit shall not time group 2 timeout commands. Execution shall continue until completion.

When the IMMED is set to one, status shall be returned within a Group 1 timeout.

6.5.6 Error Reporting

When the command operation began with the CDB IMMED bit set to one, it is possible that a deferred error may be reported in some future command

Recommended error reporting is defined in Table 242.

Table 242 – Recommended Errors for the FORMAT UNIT Command.

Error	Reference	May be Deferred
Unit Attention conditions	Table F.1	
CDB or parameter list validation errors	Table F.2	
Readiness errors	Table F.3	
Protocol errors	Table F.4	
General media access errors	Table F.5	√
Write errors	Table F.7	√
Hardware failures	Table F.8	√

6.6 GET CONFIGURATION Command

The GET CONFIGURATION command provides information about the Logical Unit capabilities – both current and potential.

Persistent Prevent may be used to control when morphing occurs. If a Persistent Prevent is enabled, the configuration should not change except under Initiator control.

This command shall not return a CHECK CONDITION Status due to a pending UNIT ATTENTION Condition. Any pending UNIT ATTENTION Condition shall not be cleared for the Logical Unit issuing the GET CONFIGURATION Command.

Features that specify implementation of the GET CONFIGURATION command are listed in Table 243.

Table 243 – Features Associated with the GET CONFIGURATION Command

Feature Number	Feature Name	Command Requirement
0001h	Core	Mandatory
0002h	Morphing	Mandatory

6.6.1 The CDB and its Parameters

6.6.1.1 The CDB

The Get Configuration CDB is shown in Table 244.

Table 244 – GET CONFIGURATION CDB

Byte	Bit	7	6	5	4	3	2	1	0	
0		OPERATION CODE (46h)								
1		Reserved						RT		
2	(MSB)	Starting Feature Number								(LSB)
3										
4		Reserved								
5		Reserved								
6		Reserved								
7	(MSB)	Allocation Length								(LSB)
8										
9		Control								

6.6.1.2 RT

The RT field identifies the type of data to be returned by the Logical Unit. The possibilities and meanings for the RT field are listed in Table 245.

Table 245 – RT Field Definitions

RT value	Definition
00b	The Logical Unit shall return the Feature Header and all Feature Descriptors supported by the Logical Unit without regard to currency.
01b	The Logical Unit shall return the Feature Header and only those Feature Descriptors in which the Current bit is set to one.
10b	The Feature Header and the Feature Descriptor identified by Starting Feature Number shall be returned. If the Logical Unit does not support the specified feature, only the Feature Header shall be returned.
11b	Reserved

6.6.1.3 Starting Feature Number

The Starting Feature Number field indicates the first Feature number to be returned. All supported Feature numbers higher than the Starting Feature Number shall be returned.

6.6.1.4 Allocation Length

The Allocation Length field specifies the maximum length in bytes of the Get Configuration response data. An Allocation Length field of zero indicates that no data shall be transferred. This condition shall not be considered an error.

6.6.2 Command Execution

6.6.2.1 GET CONFIGURATION Response Data

The GET CONFIGURATION response Data (Table 246) consists of a header field and zero or more variable length feature descriptors.

Table 246 – GET CONFIGURATION response data format

Bit	7	6	5	4	3	2	1	0
Byte								
0 – 7	Feature Header							
8 – n	Feature Descriptor(s)							

The Feature Header field to be returned is shown in Table 247.

Table 247 – Feature Header

Bit	7	6	5	4	3	2	1	0
Byte								
0	(MSB) Data Length (LSB)							
1								
2								
3								
4	Reserved							
5	Reserved							
6	(MSB) Current Profile (LSB)							
7								

The Data Length field indicates the amount of data available given a sufficient allocation length following this field. This length shall not be truncated due to an insufficient Allocation Length. If the Data Length is greater than 65 530 bytes, multiple GET CONFIGURATION commands with different Starting Feature Numbers are required for the Initiator to read all configuration data. This field is adjusted as appropriate for the given Starting Feature Number.

The maximum number of definable Features is 65,536. The maximum number of bytes that a Logical Unit may return to describe its Features in one Command is 65,534. Feature lists longer than 65,534 bytes require multiple Commands.

NOTE 13: In this standard, the entire set of defined feature descriptors amounts to less than 1 KB.

The Current Profile field shall indicate the Logical Unit’s current Profile. The Logical Unit shall select the current Profile from the list of Profiles (see

Table 78) with their CurrentP bit set. If more than one Profile is current, the largest Profile number is used. If no Profile is currently active, this field shall contain zero.

6.6.2.2 Features

Features are the smallest set of commands, pages, and behavior that may be implemented. A list of defined features is shown in Table 75.

The Feature Descriptor(s) generic format returned is defined in **Error! Reference source not found.** Each individual Feature description is defined in the appropriate sub-clause.

6.6.2.3 Profile List

This Feature identifies Profiles supported by the Logical Unit. Profiles are defined as collections of Features and provide a method to quickly determine the Logical Unit's type. This Feature is always current, even if none of the Profiles listed is current.

The Profile Descriptor format is shown in Table 77. All Profiles supported by the Logical Unit shall always be reported. The Profile Number identifies a Profile to which the Logical Unit conforms. See 5.4. Profile descriptors are returned in descending numerical order.

6.6.3 Timeouts

Command execution timeouts as specified by the Timeout Feature do not apply to the GET CONFIGURATION command.

6.6.4 Error Reporting

Recommended error reporting is defined in Table 248.

Table 248 – Recommended Errors for the GET CONFIGURATION Command

Error	Reference
CDB or parameter list validation errors	Table F.2

6.7 GET EVENT STATUS NOTIFICATION Command

The GET EVENT STATUS NOTIFICATION command requests the Logical Unit to report events and statuses as specified in the Notification Class Request field as a method of asynchronous notification. Two modes of operation are defined: polling and asynchronous.

When polling, the Initiator should issue GET EVENT STATUS NOTIFICATION commands at periodic intervals. The target shall complete this command with the most recently available event status requested. The Logical Unit shall support polling mode.

Asynchronous operation requires a transport that provides command queueing and disconnect. The Initiator should issue a single GET EVENT STATUS NOTIFICATION command. The Logical Unit shall process the command and return requested event information only when some requested event has occurred.

Only one class of event per GET EVENT STATUS NOTIFICATION command shall be reported. The priority of event reporting shall be by Event Class number where lowest Classes are higher priority.

This command shall not return CHECK CONDITION status to report a unit attention condition. Any pending unit attention condition for which a corresponding event is reported shall not be cleared for the target.

Features that specify implementation of the GET EVENT STATUS NOTIFICATION command are listed in Table 249.

Table 249 – Features Associated with the GET EVENT STATUS NOTIFICATION Command

Feature Number	Feature Name	Command Requirement
0001h	Core	Mandatory
0002h	Morphing	Mandatory

6.7.1 The CDB and its Parameters

6.7.1.1 The CDB

The GET EVENT STATUS NOTIFICATION CDB is shown in Table 250.

Table 250 – GET EVENT STATUS NOTIFICATION CDB

Byte	Bit	7	6	5	4	3	2	1	0
0		Operation Code (4Ah)							
1		Reserved							Polled
2		Reserved							
3		Reserved							
4		Notification Class Request							
5		Reserved							
6		Reserved							
7	(MSB)	Allocation Length							(LSB)
8									
9		Control							

6.7.1.2 Polled

The Polled bit is used to select operational mode. When Polled is set to zero, the Initiator is requesting asynchronous operation. If the Logical Unit does not support asynchronous operation, the command shall be terminated with CHECK CONDITION status and the values for SK/ASC/ASCQ shall be set to ILLEGAL REQUEST/INVALID FIELD IN CDB.

NOTE 14: If Polled is zero while a Group 2 timeout command is executing, the GET EVENT STATUS NOTIFICATION command may be queued, but it never terminates.

When Polled is set to one, the Initiator is requesting polled operation. The Logical Unit shall return event information for the highest priority requested event. If no event has occurred, the Logical Unit shall report the “No Change” event for the highest priority requested event class.

6.7.1.3 Notification Class Request

Notification Class Request field specifies that the Logical Unit report event(s) from the event classes requested in this field. Table 251 defines the codes listed in this field.

Table 251 – Notification Class Request field definition

Bit	Definition
0	Reserved
1	Operational Change
2	Power Management
3	External Request
4	Media
5	Multi-Initiator
6	Device Busy
7	Reserved

Lowest class number has highest priority.

Bit 7 is reserved for future standardization and shall be treated as unsupported event class. Bit 0 is perpetually reserved. If either of these bits is set to one, it shall not be considered an error.

A Notification Class Request field of zero shall not be considered an error.

6.7.1.4 Allocation Length

The Allocation Length field indicates the maximum number of bytes that shall be transferred from the Logical Unit. If Allocation Length is 4 or less, then the Logical Unit shall transfer Event Header only and shall not clear any event. An event shall be considered reported for all Allocation Lengths greater than 4. An Allocation Length of zero shall not be considered an error.

NOTE 15: The Initiator should set Allocation Length field to 8 or greater in order to retrieve Event Data correctly.

6.7.2 Command Execution

6.7.2.1 Event Status Notification Data

The Event Status Notification Response (Table 252) is a 4-byte header followed by an Event Descriptor associated with exactly one event class.

Table 252 – Event Status Notification Response

Bit	7	6	5	4	3	2	1	0
Byte								
0 – 3	Event Header							
4 – n	Event Descriptor							

The Event Header content defined in Table 253.

Table 253 – Event Header

Bit	7	6	5	4	3	2	1	0
Byte								
0	(MSB) Event Descriptor Length (LSB)							
1								
2	NEA	Reserved				Notification Class		
3	Supported Event Classes							

The Event Descriptor Length field specifies the number of bytes of data that follows the Event Status Notification Header.

If NEA (No Event Available) is set to one, the Logical Unit supports none of the requested notification classes. If NEA is set to zero, at least one of the requested notification classes is supported.

The Notification Class field specifies the class of notification as defined in Table 254. If NEA is set to one, this field shall contain 000b.

Table 254 – Notification Class Field Values

Field	Description
000b	No requested Event Classes are supported
001b	Operational Change Request/Notification
010b	Power Management
011b	External Request
100b	Media
101b	Multiple Initiators
110b	Device Busy
111b	Reserved

Supported Event Classes field specifies the event classes that the Logical Unit supports. See Table 251.

The general format of the Event Descriptor is shown in Table 255.

Table 255 – General Event Descriptor Format

Bit	7	6	5	4	3	2	1	0
Byte	Reserved				Event Code			
0								
1 – N	Specific Event Information							

When Event Code is zero, no change has occurred. Non-zero values for Event Code are Event specific.

Upon reporting an event to the Initiator, this field is reported as 0h on subsequent GET EVENT STATUS NOTIFICATION commands until a new event of the same class occurs.

6.7.2.2 Operational Change Events

When the Notification Class code in the Event Header is 001b, an Operational Change Event Descriptor (Table 256) follows the header.

An Operational Change event indicates that the operational capabilities or parameters may have changed for this Logical Unit.

Table 256 – Operational Change Event Descriptor

Bit	7	6	5	4	3	2	1	0
Byte								
0	Reserved				Event Code			
1	Persistent Prevented	Reserved			Operational Status			
2	(MSB) Operational Change							
3	(LSB)							

Persistent Prevented bit reports the current state of the persistent prevent for the Logical Unit. See 5.3.4.

The Event Code (Table 257) identifies the operational change. Some Event codes present in earlier standards are reserved in this standard. Those codes are Legacy and defined in E.2.1.

Table 257 – Event Codes For the Operational Change Class

Code	Status	Description
0h	NoChg	No changes in the Logical Unit Operational state
1h	Reserved	-
2h	Logical Unit has changed Operational state	The Logical Unit has changed Operational state
3h – Fh	Reserved	-

If a new Event occurs before an existing Event is reported to the Initiator, the new event shall replace the old Event if the new Event has a higher Code than the old Event. Otherwise, the new Event shall be deleted.

The Operational Status field is reserved and shall be set to zero (0h) by Logical Units that comply with this standard. Non-zero values in the Operational Status field are Legacy; see E.2.1.

The Operational Change field (Table 258) reports the source of the change. If this field contains a non-zero value, the Initiator should send a GET CONFIGURATION command in order to discover any configuration changes. Some Operational Change field codes present in earlier standards are reserved in this standard. Those codes are Legacy and defined in E.2.1.

Table 258 – Operational Change

Code	Event	Description
0h	NoChg	No changes in operational state requested or performed
1h	Feature Change	An unspecified event may have changed Feature currency
2h – FFFFh	Reserved	-

6.7.2.3 Power Management Events

When the Notification Class code in the Event Header is 010b, a Power Management Event Descriptor (Table 259) follows the header.

A Power Management Event is reported whenever there is a change to power status. Power changes may occur due to a command from the Initiator or a timeout as specified in the Timeout and Protect Mode Page (see 7.9).

Table 259 – Power Management Event Descriptor

Bit	7	6	5	4	3	2	1	0
Byte								
0	Reserved				Event Code			
1	Power Status							
2	Reserved							
3	Reserved							

The Power Event field (Table 260) identifies the power change event.

Table 260 – Power Event Field

Code	Event	Description
0h	NoChg	No changes in power state, or in power state transition
1h	PwrChg-Successful	The Logical Unit successfully changed to the specified power state
2h	PwrChg-Fail	The Logical Unit failed to enter the last requested state, and is still operating at the power state specified in the Power Status field.
3h – Fh	Reserved	

If the Logical Unit is commanded to go the same state that it is currently in, the next GET EVENT STATUS NOTIFICATION (Power Management Class) command shall report a Power Change Successful event.

The Power Status field (Table 262) indicates the current power state of the Logical Unit. The Logical Unit shall be set to Standby (3h) by a Hard reset, a power-on reset or a Device reset (issued from a Sleep state).

Table 261 – Power Status Field

Code	Status	Description
0h	Reserved.	-
1h	Active	The Logical Unit is in Active state
2h	Idle	The Logical Unit is in Idle state
3h	Standby	The Logical Unit is in Standby state
4h	Sleep	The Logical Unit is about to enter Sleep state
5h – Fh	Reserved	-

6.7.2.4 External Request Events

When the Notification Class code in the Event Header is 011b, an External Request Event Descriptor (Table 262) follows the header.

NOTE 16: The Load/Eject button is not included as an external event.

The External Request Event field reports external requests to change state and notifications of changes in Logical Unit state.

Table 262 – External Request Descriptor

Byte	Bit	7	6	5	4	3	2	1	0
0		Reserved				Event Code			
1	Persistent Prevented	Reserved				External Request Status			
2	(MSB)	External Request							(LSB)
3									

The External Request Events are listed in Table 263.

Table 263 – External Request Events

Code	Event	Description
0h	NoChg	No changes in the Logical Unit Operational state performed or requested
1h	Logical Unit Key Down	A front, back, or remote button has been depressed
2h	Logical Unit Key Up	A front, back, or remote button has been released
3h	External Request Notification	The Logical Unit has received a command from another Initiator that requires an action that may interfere with the Persistent Prevent owner's operation.
4h – Fh	Reserved	-

The Initiator may respond to Events 1-3 with no action, an appropriate action, or with a SEND EVENT command. If a Persistent Prevent is in place for the Initiator, the Logical Unit shall not perform the requested action. If a Persistent Prevent is not in place for the Initiator, the Logical Unit shall notify the Initiator of actions that change Logical Unit state.

The Initiator may respond to Event 4 with a GET CONFIGURATION command. Events 1 and 2 should occur in pairs.

The Persistent Prevented bit reports the current state of the persistent prevent for the Logical Unit. This bit shall be set to 1 if any Initiator has performed a persistent reservation.

The External Request Status field (Table 264) reports the Logical Unit's ability to respond to the Initiator.

Table 264 – External Request Status Codes

Code	Status	Description
0h	Ready	The Logical Unit is ready for operation
1h	Other Prevent	Indicates that another Initiator has an active Persistent Prevent. The Persistent Prevented bit shall be set to one.
2h – Fh	Reserved	Reserved

The External Request field (Table 265) reports the operation requested or operation that has been performed. The request usually originates from the unit's own user interface (i.e., front panel buttons) or from another Initiator.

Table 265 – External Request Codes

Code	Status	Description
0h	No Request	No requests are pending
1h	Overrun	The Request Queue has overflowed, External Request Events may be lost.
2h – 100h	Reserved	
101h	Play	The play button was pressed or another Initiator requested a play operation.
102h	Rewind/back	The rewind/back button was pressed or another Initiator requested a rewind/back operation.
103h	Fast Forward	The fast/forward button was pressed or another Initiator requested a fast/forward operation.
104h	Pause	The pause button was pressed or another Initiator requested a pause.
105h	Reserved	
106h	Stop	The stop button was pressed or another Initiator requested a stop.
107h – 1FFh	Reserved	
200h – 2FFh	ASCII Button	A front panel button was pressed or equivalent action requested by another Initiator. The button has an associated ASCII value. The ASCII value shall be the least significant 8 bits of the Code.
300h – EFFFh	Reserved	
F000h – FFFFh	Vendor Unique	

6.7.2.5 Media Events

When the Notification Class code in the Event Header is 100b, a Media Event Descriptor follows the header.

Table 266 – Media Event Descriptor

Bit	7	6	5	4	3	2	1	0
Byte								
0	Reserved				Event Code			
1	Media Status							
2	Start Slot							
3	End Slot							

6.7.2.5.1 Event Code

The Media Event field is defined in Table 267.

Table 267 – Media Event Format

Code	Event	Description
0h	NoChg	Media status is unchanged
1h	EjectRequest	The Logical Unit has received a request from the user (usually through a mechanical switch on the Logical Unit) to eject the specified slot or media.
2h	NewMedia	The specified slot (or the Logical Unit) has received new media, and is ready to access it.
3h	MediaRemoval	The media has been removed from the specified slot, and the Logical Unit is unable to access the media without user intervention. This applies to media changers only.
4h	MediaChanged	The user has requested that the media in the specified slot be loaded. This applies to media changers only.
5h	BgformatCompleted	A MRW or DVD+RW background format has completed. Since MRW and DVD+RW Logical Units are capable of generating multiple media events concurrently, such Logical Units shall be capable of queuing media events.
6h	BgformatRestarted	A MRW or DVD+RW background format has been automatically restarted by the Logical Unit. Since MRW and DVD+RW Logical Units are capable of generating multiple media events concurrently, such Logical Units shall be capable of queuing media events.
7h – Fh	Reserved	

6.7.2.5.2 Media Status

The Media Status byte is defined in Table 268.

Table 268 – Media Status Byte Definition

Bit	7	6	5	4	3	2	1	0
Byte								
0	Reserved						Media Present	Door or Tray open

If the Media Present bit is set to zero, no media is present in the Logical Unit. If the Media Present bit is set to one, media is present in the Logical Unit.

If the Door or Tray Open bit is set to zero, the Tray or Door mechanism is in the closed state. If the Door or Tray Open bit is set to one, the Tray or Door mechanism is in the open state. If the Logical

Unit does not have either a tray or a door, this bit shall be set to zero.

6.7.2.5.3 Start Slot

Start Slot field defines the first slot of a multiple slot Logical Unit the media status notification applies to. For Logical Units that do not support multiple slots, this field shall be reserved.

The slot numbers are defined in the MECHANISM STATUS command, see 6.11.

6.7.2.5.4 End Slot

End Slot field defines the last slot of a multiple slot Logical Unit the media status notification applies to. For Logical Units that do not support multiple slots, this field shall be reserved.

The slot numbers are defined in the MECHANISM STATUS command, see 6.11.

6.7.2.6 Multiple Initiator Events

When the Notification Class code in the Event Header is 101b, a Multiple Initiator Event Descriptor (Table 268) follows the header.

Multi-Initiator Class Events notify the Initiator of requests for control by other Initiators.

Table 269 – Multiple Initiator Descriptor

Bit	7	6	5	4	3	2	1	0
Byte								
0	Reserved				Event Code			
1	Persistent Prevented	Reserved			Multiple Initiator Status			
2	(MSB) Multiple Initiator Priority							
3	(LSB)							

The Multi-Initiator Event field reports requests for control of and reporting of changes in Logical Unit state. If a Persistent Prevent is in place for that Initiator, the Logical Unit shall not perform the action requested. If a Persistent Prevent is not in place for that Initiator, the Logical Unit shall notify the Initiator of actions that change the Logical Unit state.

The Multi-Initiator Events are listed in Table 272.

Table 270 – Multiple Initiator Event Format

Code	Event	Description
0h	NoChg	No changes in the Logical Unit Operational state performed or requested
1h	Control Request	Another Initiator has requested Logical Unit control.
2h	Control Grant	Another Initiator has received Logical Unit control.
3h	Control Release	Another Initiator has released Logical Unit control.
4h – Fh	Reserved	

The Initiator may respond to Events 1-3 with no action or an appropriate Persistent Prevent or Persistent Allow.

The Persistent Prevented bit reports the current state of the Persistent Prevent for the Logical Unit. The Multiple Initiator Status (Table 271) field reports the Logical Unit ability to respond to the Initiator.

Table 271 – Multiple Initiator Status Codes

Code	Status	Description
0h	Ready	The Logical Unit is ready for operation
1h	Other Prevent	Indicates that another Initiator has an active Persistent Prevent. The Persistent Prevented bit shall be set to one.
2h – Fh	Reserved	Reserved

The Multiple Initiator Priority (Table 272) reports the other Initiator's relative priority.

Table 272 – Multiple Initiator Priority Codes

Code	Status	Description
0h	No Request	No requests are pending
1h	Low	There are no tasks pending on the Initiator for this Logical Unit.
2h	Medium	There are no critical tasks pending on the Initiator for this Logical Unit.
3h	High	There are critical tasks pending on the Initiator for this Logical Unit
4h – FFFFh	Reserved	

6.7.2.7 Device Busy Events

When the Notification Class code in the Event Header is 110b, a Device Busy Event Descriptor (Table 273) follows the header.

Device Busy Events are used to notify the Initiator of commands that are executing but that require an abnormally long time to complete. Conditions that may cause the Logical Unit to become Busy are defined in 4.1.6.2.

Table 273 – Device Busy Event Descriptor

Bit	7	6	5	4	3	2	1	0
Byte								
0	Reserved				Event Code			
1	Device Busy Status							
2	(MSB) Time							
3	(LSB)							

The Device Busy Event code is defined in Table 274.

Table 274 – Device Busy Event Codes

Code	Event	Description
0h	NoChg	The Logical Unit Busy state has not changed.
1h	Change	The Logical Unit Busy state has changed
2h – Fh	Reserved	

The Device Busy Status byte is defined in Table 275.

Table 275 – Device Busy Status

Code	Status	Description
00h	Not Busy	The Logical Unit is Not Busy.
01h	Busy	The Logical Unit is Busy.
02h – FFh	Reserved	

The Time field is the predicted amount of time remaining for the Logical Unit to become not busy, in units of 100ms. If the Device Busy Status is Not Busy, the contents of the Time field are unspecified. In order to assure accurate timing information, any command that may cause the Logical Unit Busy condition should not be queued.

If both the Initiator and the Logical Unit support command queuing, the Initiator should issue a GESN command requesting only the Device Busy Event class with the Polled bit in the CDB set to zero prior to issuing the command that may cause a Logical Unit Busy condition. If the Logical Unit becomes busy, the first GESN command shall be performed to report the Change (Not-Busy to Busy transition). The Initiator may issue another GESN command for the purpose of being notified of completion. Once the command has stopped executing, the second GESN command shall be performed to report the Change (Busy to Not-Busy transition).

Figure 48 shows the flow of execution of a command that may cause a Logical Unit Busy condition.

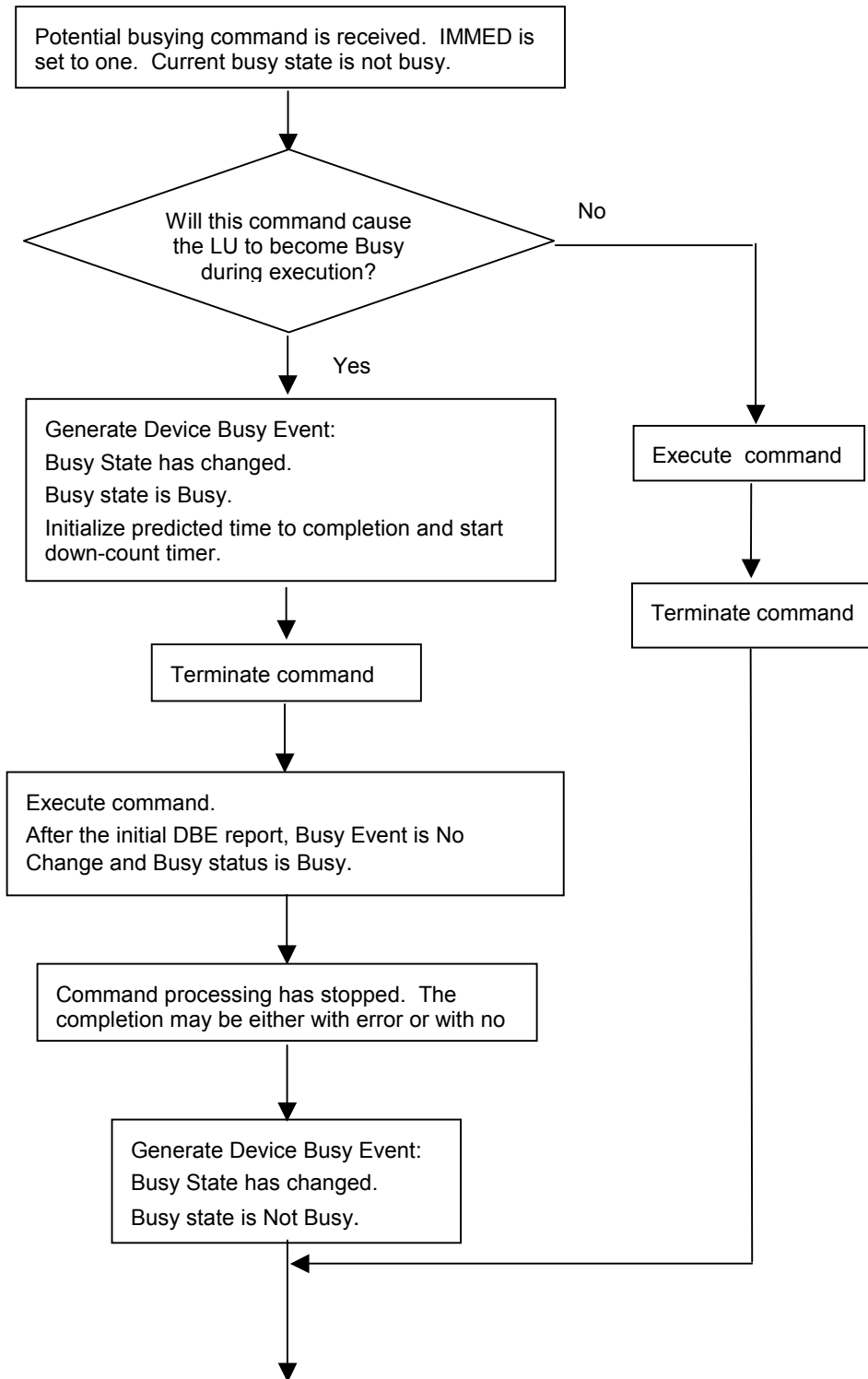

Figure 48 – Execution of a command that may cause Logical Unit Busy

6.7.3 Timeouts

Command execution timeouts as specified by the Timeout Feature do not apply to the GET EVENT STATUS NOTIFICATION command.

6.7.4 Error Reporting

Recommended error reporting for the GET EVENT STATUS NOTIFICATION Command is defined in Table 276.

Table 276 – Recommended Errors for GET EVENT STATUS NOTIFICATION Command

Error	Reference
CDB or parameter list validation errors	Table F.2

6.8 GET PERFORMANCE Command

6.8.1 Introduction

The GET PERFORMANCE command provides a method for the Initiator to obtain detailed information about the performance of the Logical Unit. The command also provides a means for the Initiator to get current status and events that occurred during Stream recording/playback operation. Performance parameters are reported separately for read and write.

Table 277 shows the features associated with the GET PERFORMANCE command.

Table 277 – Features Associated with the GET PERFORMANCE Command

Feature Number	Feature Name	Command Requirement
0107h	Real-time Streaming	Mandatory
NOTE 1: The command requirement is valid only when the feature is current.		

6.8.2 The CDB and its Parameters

6.8.2.1 The CDB

The GET PERFORMANCE CDB is shown in Table 278.

Table 278 – GET PERFORMANCE CDB

Bit	7	6	5	4	3	2	1	0
0	Operation Code (ACh)							
1	Reserved			Data Type				
2	(MSB) Starting LBA (LSB)							
3								
4								
5								
6	Reserved							
7	Reserved							
8	(MSB) Maximum Number of Descriptors (LSB)							
9								
10	Type							
11	Control							

6.8.2.2 Data Type

The Data Type field definition is dependent upon the Type field value.

6.8.2.3 Starting LBA

Use of the Starting LBA field is determined by the contents of the Type field.

6.8.2.4 Maximum Number of Descriptors

The Logical Unit shall not return more performance descriptors than specified by the Maximum Number of Descriptors field. If Maximum Number of Descriptors is zero, then only the descriptor header shall be returned.

6.8.2.5 Type

The Type field specifies the type of data requested. Table 279 shows the valid values for Type.

Table 279 – Type Field Definitions

Type Field	Description
00h	Performance data
01h	Unusable Area data
02h	Defect Status data
03h	Write Speed Descriptor
04h	DBI
05h	DBI Cache Zone
06h – FFh	Reserved

If the logical unit does not support the specified value of Type field for the mounted medium, the logical unit shall terminate this command with CHECK CONDITION status and set SK/ASC/ASCQ values to ILLEGAL REQUEST/INVALID FIELD IN CDB.

6.8.3 Command Execution

6.8.3.1 Overview

The performance response (Table 280) shall contain a Performance header and zero or more Performance descriptors.

Table 280 – Performance response format

Bit	7	6	5	4	3	2	1	0
Byte								
0 – 7	Performance Header							
8 – n	Performance Descriptor(s)							

The Performance Header is defined in Table 281.

Table 281 – Performance Header

Bit	7	6	5	4	3	2	1	0
Byte								
0	(MSB) Performance Data Length (LSB)							
1								
2								
3								
4	Reserved						Write	Except
5	Reserved							
6	Reserved							
7	Reserved							

The Performance Data Length field shall specify the amount of result data not including the Performance Data Length. This value is not modified when the allocation length indicated by the Maximum Number of Descriptors is insufficient to return all of the data available.

The values of Write and Except are dependent upon the Performance Type.

6.8.3.2 Performance (Type field = 00h)

The command reports its characteristics of reading/writing performance.

The Data Type Field (Table 282) is a collection of bit fields that specify the form of the returned descriptor.

Table 282 – Data Type Field Definitions for Type = 00h

Data Type Bit Fields				
4	3	2	1	0
Tolerance		Write	Except	
00b = Reserved		0b = Read Performance	00b = nominal performance	
01b = Reserved			01b = Entire performance list	
10b = 10%, nominal; 20%, exceptions		1b = Write Performance	10b = performance exceptions only	
11b = Reserved			11b reserved	

The Starting LBA field in the CDB is valid only when Except = 01b. If Except = 01b, the Starting LBA field shall indicate the starting point for returning performance data. All performance data shall be for logical block addresses greater than or equal to this LBA.

The Write bit (in the Header), when set to zero, shall indicate that the result data is for read performance using the nominal command for the data type. When set to one, shall indicate that the result data is for write performance.

The Except bit (in the Header), when set to zero, shall indicate that the result data is for nominal performance (see Table 283). When set to one, shall indicate that the result data is for exception conditions (Table 284). Performance Descriptors shall be returned for the current medium. If no media is present, Performance Descriptors for the fastest medium shall be returned.

The Performance Descriptors (Table 283) for nominal performance are intended to give the Initiator an approximation of Logical Unit performance. All numbers are nominal. On CD media, all sectors shall be reported as 2 352 byte sectors. The descriptor includes a Start LBA value, a Start Performance value in increments of 1 000 Bytes/second, an End LBA value, and an End Performance value in increments of 1 000 Bytes/second.

Table 283 – Performance Descriptor – Nominal Performance

Bit	7	6	5	4	3	2	1	0
0	(MSB) Start LBA (LSB)							
1								
2								
3								
4	(MSB) Start Performance (LSB)							
5								
6								
7								
8	(MSB) End LBA (LSB)							
9								
10								
11								
12	(MSB) End Performance (LSB)							
13								
14								
15								

The Start LBA field contains the first logical block address of the extent described by this descriptor.

The Start Performance field contains the nominal Logical Unit performance at the Start LBA.

The End LBA field contains the last logical block address of the extent described by this descriptor.

The End Performance field contains the nominal Logical Unit performance at the End LBA.

Table 284 – Performance Descriptor – Exceptions

Byte	Bit	7	6	5	4	3	2	1	0
0	(MSB)	LBA							
1									
2									
3									
4	(MSB)	Time							
5									

The LBA field shall indicate that there is a seek delay between (LBA – 1) and LBA.

The Time field shall indicate the expected additional delay between (LBA – 1) and LBA from nominal, in units of tenths of milliseconds (100 microseconds). This seek delay may be due to linear replacement, zone boundaries, or other media dependent Features. The expected additional delay should represent the typical time expected for the type of exception described.

NOTE 17: A block replaced by linear replacement may cause two exceptions to appear in the Exception Descriptor list – one between the non-replaced area and the beginning of the replaced block, and one from the end of the replaced block back to the non-replaced area.

6.8.3.3 Unusable Area Data (Type=01h)

This command reports data to the Initiator that how the physically unusable areas are allocated on the mounted writable media. If the mounted media is not a writable media, the Logical Unit shall terminate the command with CHECK CONDITION status and set SK/ASC/ASCQ values to ILLEGAL REQUEST/INVALID FIELD IN CDB.

The corresponding parameter field allocation is specified in Table 285.

The Unusable Area Type field specifies the type of the unusable area to be transferred. See Table 285.

Table 285 – Unusable Area Type values

Unusable Area Type value	Description
000b	Zone boundary information
001b	PDL information
010b	SDL information
Others	Reserved

The Write and Except bits in the Performance Header for Unusable Area data are not used and shall be set to zeros.

All Unusable Area data shall be for LBAs that are greater than or equal to the Starting LBA specified in the CDB. Each Unusable Area Descriptor shall be transferred to the Initiator in ascending order.

Table 286 – Unusable Area Descriptor

Byte	Bit	7	6	5	4	3	2	1	0
0	(MSB)	LBA							(LSB)
1									
2									
3									
4	(MSB)	Number of Unusable Physical Blocks							(LSB)
5									
6									
7									

The LBA field shall specify the first LBA of the unusable area if the Unusable Area Type field in CDB is set to 010b. The LBA field shall specify the LBA just before the unusable area when the Unusable Area Type field in CDB is set to 000b or 001b.

The Number of Unusable Physical Blocks field shall specify number of physical blocks included in the specified unusable area. When the Unusable Area Type field in CDB is set to 000b, this field is reserved.

6.8.3.4 Defect Status data (Type=02h)

This command reports Defect Status data to the Initiator that is created by certification on the Restricted Overwrite media. If the mounted media is not a Restricted Overwrite media or if the Logical Unit does not support certification, this command shall be terminated with CHECK CONDITION status and SK/ASC/ASCQ values shall be set to ILLEGAL REQUEST/INVALID FIELD IN CDB.

The Data Type field in CDB shall be set to zero.

All Defect Status data shall be for LBAs that are greater than or equal to the Starting LBA specified in the CDB.

The Write and Except bits in the Performance Header for Defect Status data are not used and shall be set to zeros.

Defect Status Descriptors shall be transferred to the Initiator in ascending order. If the certified areas are non-contiguous and scattered, separate descriptors, to exclude the void areas shall return the Defect Status Descriptor(s).

The Defect Status Data Length field shall specify the amount of data that follows the Defect Status Data Length field. If there is no Defect Status data on the media, Defect Status Data Length field shall be set to 4 and no Defect Status Descriptor shall be transferred.

Table 287 – Defect Status Descriptor

Bit	7	6	5	4	3	2	1	0
Byte								
0	(MSB) Start LBA (LSB)							
1								
2								
3								
4	(MSB) End LBA (LSB)							
5								
6								
7								
8	Blocking Factor							
9	Reserved				First Bit Offset			
10	DS #8	DS #7	DS #6	DS #5	DS #4	DS #3	DS #2	DS #1
...
2047	DS # 16 304	DS # 16 303	DS # 16 302	DS # 16 301	DS # 16 300	DS # 16 299	DS # 16 298	DS # 16 297

The Start LBA field contains the start Logical Block Address of the certified sector where the following Defect Status (DS #n bits) starts. The returned Logical Block Address shall be the first sector of a Block that contains logical blocks specified by the Blocking Factor field.

The End LBA field contains the end Logical Block Address of the certified sector where the following Defect Status (DS #n bits) ends. The returned Logical Block Address shall be the last sector of a Block that contains logical blocks specified by the Blocking Factor field.

The Blocking Factor field shall indicate the number of logical blocks per DS #m bit. In the case of DVD-RW, this field shall be set to 16 as an ECC Block.

The First Bit offset field shall indicate the start valid bit number in the byte 10. The lower bits in the byte 10 are invalid. e.g., if First Bit offset field contains 3, bit 3 of byte 10 has the defect status of the block that contains the Logical block specified Start LBA field. From bit 2 to bit 0 are invalid in this case.

DS #n bit contains the certification result of the block #m. When DS #n bit is set to 0, indicate that the block has no defect and is able to read and write the block safely. When DS #n bit is set to 1, indicates that the block has defect and might not be able to read and write the block safely.

6.8.3.5 Write Speed (Type=03h)

This command reports a list of possible Write Speed descriptors. If recordable media is mounted, Logical Unit shall report the list of speeds that are available for the Blocks of the current mounted medium. If no recordable media is mounted, the Logical Unit shall report the most appropriate list of speeds or only the maximum recording speed. Write Speed descriptors shall be reported in descending order of the Write Speed value. If the Logical Unit supports both CLV and CAV on the media, then the Logical Unit shall report all CLV descriptors first. The Initiator may determine a desired write speed descriptor from the result of this command, then set the Write Speed accordingly via the SET STREAMING command. To apply this descriptor to the SET STREAMING command, the Start LBA field is set to 0, the Read Time field and the Write Time field are set to 1000 (1sec).

Table 288 – Write Speed Descriptor

Byte	Bit	7	6	5	4	3	2	1	0
0		Reserved			WRC		RDD	Exact	MRW
1		Reserved							
2		Reserved							
3		Reserved							
4	(MSB)	End LBA							
5									
6									
7									
8	(MSB)	Read Speed							
9									
10									
11									
12	(MSB)	Write Speed							
13									
14									
15									

The Write Rotation Control (WRC) field specifies the type of the medium Rotation Control. See Table 289.

Table 289 – Write Rotation Control values

WRC value	Description
00b	CLV and non-pure CAV
01b	Pure CAV
Others	Reserved

Media default rotation control is the rotation control defined by the media specification. Media default rotation control is typically:

- a) CD-R/RW CLV
- b) DVD-R/-RW CLV
- c) DVD-RAM ZCLV
- d) DVD+RW CLV

If default rotation control is CAV, this field shall be set to zero.

RDD bit shall be set to zero.

Exact bit of one indicates that the Logical Unit may perform the recording operation specified by Write Speed Descriptor on the whole media mounted. If the Logical Unit is uncertain, this bit shall set to zero.

The MRW bit indicates that this Write Speed Descriptor is suitable for mixture of read and write (e.g. overwrite mode).

The End LBA field shall indicate the medium capacity if a medium is mounted. The value shall be same as the value reported by READ CAPACITY command. If no medium is mounted, the Logical Unit shall report the maximum capacity of the most appropriate media.

The Read Speed field shall indicate the lowest read performance data of all Blocks in kilobytes per second.

The Write Speed field shall indicate the lowest write performance data of all Blocks in kilobytes per second.

NOTE 18: The Write Speed (Type field = 03h) format may not be able show the difference between 6X CLV and 6X-8X ZCLV on DVD-R/+R media. 6X-8X ZCLV may be regarded as 8X CLV. The correct write speed profile and read speed profiles that are selected are shown by Performance (Type field = 00h) format.

6.8.3.6 DBI (Type=04h)

This command reports a list of Defective Block Information (DBI) data that is a certification result of the medium. To keep compatibility among three DBI memory models described in 4.6.4.5, “DBI memory management”, the Initiator should specify the correct logical block address to be read for defect information in the Starting LBA field of GET PERFORMANCE CDB.

If the logical unit supports Enhanced Defect Reporting Feature but this Feature is not current, only DBI data Header shall be reported. If the logical unit does not support Enhanced Defect Reporting Feature, this command shall be terminated with CHECK CONDITION status and SK/ASC/ASCQ values shall be set to ILLEGAL REQUEST/INVALID FIELD IN CDB.

The result data shall be formatted as listed in Table 277.

Table 290 – DBI data

Bit	7	6	5	4	3	2	1	0
Byte								
0-7	DBI data Header							
8-n	DBI Descriptor(s)							

Table 291 – DBI data Header

Bit	7	6	5	4	3	2	1	0
Byte								
0	(MSB) DBI Data Length (LSB)							
1								
2								
3								
4-7	Reserved							

The DBI Data Length field specifies the length in bytes of the following result data. The DBI Data Length value does not include the DBI Data Length field itself. This value is not modified when the Maximum number of descriptors is insufficient to return all of the DBI data available.

Table 292 – DBI Descriptor

Bit	7	6	5	4	3	2	1	0
Byte								
0	(MSB) Start LBA of defective blocks (LSB)							
1								
2								
3								
4	(MSB) Number of consecutive defective blocks (LSB)							
5								
6	Reserved			DBIF	Error Level Type			
7	Reserved							

The Start LBA of defective blocks field indicates the start LBA of defective blocks on the medium. The value shall be the packet start LBA that the packet includes the sector specified by the Starting LBA field in CDB.

The Number of consecutive defective blocks field indicates the number of consecutive defective blocks from the LBA specified by the Start LBA of defective blocks field.

The DBI Full (DBIF) bit indicates that incomplete verify operation occurs due to DBI memory full when Simple DBI memory model or small DBI cache memory model is used (see 4.6.4.5, “DBI memory management”). If this bit is set to 1, the VERIFY (10) or WRITE AND VERIFY (10) command was terminated at the address calculated from this descriptor before certification completion of specified number of blocks in CDB. The actual terminated address of VERIFY (10) or WRITE AND VERIFY (10) command is “Start LBA of defective blocks” + “Number of consecutive defective blocks” – 1. To continue the verification of the blocks, the Initiator should issue VERIFY (10) command from “Start LBA of defective blocks” + “Number of consecutive defective blocks” address.

If this bit is set to 0, indicates that the VERIFY (10) or WRITE AND VERIFY (10) command is terminated without DBI memory full.

At the beginning of the next VERIFY (10)/WRITE AND VERIFY (10) command or at the medium change, the DBIF bit shall be set to zero. By transferring the DBI descriptor of DBIF = 1 or by performing of READ (10)/READ (12) command, this bit shall not be cleared.

In the case of small DBI cache memory model, when WDBI cache is updated by the WRITE (10)/WRITE (12) command, the DBIF bit shall be set to zero.

The Error Level Type field indicates the type of the error level of the defective blocks. See Table 280.

Table 293 – Error Level Type values

Error Level Type value	Error Level Type	Description
0	Type 1	Recovered light defect in specified defective blocks. Data in the blocks may be recovered by error correction.
1	Type 2	Recovered heavy defect in specified defective blocks. Data in the blocks may be recovered by error correction and multiple retry seek/read action.
2	Type 3	Un-recovered read/seek error defect in specified defective blocks.
3	Type 4	Write error occurs in the specified defective blocks. Data had not be written on the sectors.
Others	Others	Reserved

6.8.3.7 DBI cache zone (Type=05h)

This command reports a list of Defective Block Information (DBI) data that is a certification result of the medium. To keep compatibility among three DBI memory models described in 4.6.4.5, “DBI memory management”, the Initiator should specify the correct logical block address to be read for defect information in the Starting LBA field of GET PERFORMANCE CDB.

If the logical unit supports Enhanced Defect Reporting Feature but this Feature is not current, only DBI data Header shall be reported. If the logical unit does not support Enhanced Defect Reporting Feature, this command shall be terminated with CHECK CONDITION status and SK/ASC/ASCQ values shall be set to ILLEGAL REQUEST/INVALID FIELD IN CDB.

The result data shall be formatted as listed in Table 544.

The DBI cache zone descriptor provides a way for the Initiator to indicate to the logical unit that the application has specific request for Logical Unit behavior of small DBI cache model in DRT-DM mode. Disc volume space is divided into a few DBI cache zones. RDBI and WDBI memory shall be allocated for each DBI cache zones. Minimally 2 DBI cache zones shall be supported. Number of supported DBI cache zone is shown in Number of DBI cache zones field of Table 113 – Enhanced Defect Reporting Feature Descriptor.

If logical unit supports “Simple DBI memory model” (see 4.6.4.5.2), the logical unit shall terminate this command with CHECK CONDITION status and SK/ASC/ASCQ values shall be set to ILLEGAL REQUEST/INVALID FIELD IN CDB. If logical unit supports “Large DBI buffer memory model” (see 4.6.4.5.3), the logical unit shall report single DBI cache zone that starts from LBA 0 to the end of the medium.

The descriptor data shall be formatted as listed in Table 546 – DBI cache zone Descriptor(s).

6.8.4 Timeouts

The GET PERFORMANCE command belongs to timeout group 1. If the command is terminated with CHECK CONDITION status due to a timeout, sense bytes SK/ASC/ASCQ shall be set to UNIT ATTENTION/INSUFFICIENT TIME FOR OPERATION.

6.8.5 Error Reporting

Recommended error reporting is defined in Table 294.

Table 294 – Recommended errors for GET PERFORMANCE Command

Error	Reference
Unit Attention conditions	Table F.1
CDB or parameter list validation errors	Table F.2
Readiness errors	Table F.3
General media access errors	Table F.5
Hardware failures	Table F.8

6.9 INQUIRY Command

6.9.1 Introduction

The INQUIRY Command requests that information regarding identification of the Logical Unit be sent to the Initiator. Options allow the Initiator to request additional information about the Logical Unit. Features that specify implementation of the INQUIRY command are listed in Table 295.

Table 295 – Features Associated with the INQUIRY Command

Feature Number	Feature Name	Command Requirement
0001h	Core Feature	Mandatory

The INQUIRY command is described in SPC-3. The description of command behavior is consistent for all Logical Units, however, there are variations in INQUIRY data for ATAPI and USB connected Logical Units.

6.9.2 INQUIRY Data for ATAPI and USB Logical Units

ATAPI and USB Logical Units shall have at least 36 bytes if INQUIRY data available according to Table 296.

Table 296 – INQUIRY Data for ATAPI and USB Logical Units

Field	Value	Field	Value
Peripheral Device Type	00101b	MCHNGR	0b
Peripheral Qualifier	000b	MultIP	0b
RMB	1b	VS1	0b
Version	According to SPC-3	EncServ	0b
Response Data Format	0011b	BQUE	0b
HiSup	0b	VS2	0b
NormACA	0b	CmdQue	0b
Protect	0b	LINKED	0b
3PC	0b	SYNC	0b
TPGS	0b	WBUS16	0b
ACC	0b	Vendor Identification	According to SPC-3
SCCS	0b	Product Identification	According to SPC-3
ADDR16	0b	Product Revision Level	According to SPC-3

All fields beyond byte 35 may be available in ATAPI and USB Logical Units. If available, those fields shall be according to SPC-3.

6.9.3 Timeouts

Command execution timeouts as specified by the Timeout Feature do not apply to the INQUIRY command.

6.9.4 Error Reporting

Table 297 describes errors that may occur during the operation of the Command or that may cause a CHECK CONDITION status to be reported.

Table 297 – INQUIRY Command Errors

Error	Reference
CDB or parameter list validation errors	Table F.2

6.10 LOAD/UNLOAD MEDIUM Command

6.10.1 Introduction

The LOAD/UNLOAD MEDIUM command requests the Logical Unit Changer to load or unload a Disc. This command is associated with the features listed in Table 298.

Table 298 – Features Associated with the LOAD/UNLOAD MEDIUM Command

Feature Number	Feature Name	Command Requirement
0102h	Embedded Media Changer	Mandatory
NOTE 1: The command requirement is valid only when the feature is current.		

6.10.2 The CDB and its Parameters

6.10.2.1 The CDB

The LOAD/ONLOAD MEDIUM CDB is shown in Table 299.

Table 299 – LOAD/UNLOAD MEDIUM CDB

Byte	Bit	7	6	5	4	3	2	1	0
0		OPERATION CODE (A6h)							
1		Reserved			Reserved				IMMED
2		Reserved							
3		Reserved							
4		Reserved						LoUnlo	Start
5		Reserved							
6		Reserved							
7		Reserved							
8		SLOT							
9		Reserved							
10		Reserved							
11		Control							

6.10.2.2 IMMED

If the IMMED is set to zero, the command shall not be terminated until the load/unload operation has completed. If the IMMED bit is set to one the Logical Unit shall return status as soon as the CDB has been validated.

6.10.2.3 Start and LoUnlo

Meanings of the Start and LoUnlo bits are defined in Table 300.

Table 300 – LoUnlo/Start Operation

LoUnlo	Start	Operation
0	0	Abort any prior changer command
0	1	Reserved
1	0	Unload media. The Slot parameter has no meaning
1	1	Either move the disc in the selected slot to the play position or select the specified slot for use with media access commands

6.10.2.4 Slot

The Slot field indicates the Slot to be loaded. The Logical Unit should always initialize (Load) Slot 0 at Power On or Hard Reset.

If a Load is requested when the requested slot does not contain a disc, the Logical Unit shall terminate the command with CHECK CONDITION Status and set SK/ASC/ASCQ values to NOT READY/MEDIUM NOT PRESENT.

If an Unload is requested when the Play Position does not contain a disc, the Logical Unit shall terminate the command with CHECK CONDITION Status and set SK/ASC/ASCQ values to ILLEGAL REQUEST/INVALID FIELD IN CDB for the Slot Byte.

6.10.3 Command Execution

No UNIT ATTENTION Condition shall be generated for the Initiator issuing the LOAD/UNLOAD MEDIUM Command when discs are loaded or unloaded from the playing position.

6.10.4 Timeouts

The LOAD/UNLOAD MEDIUM command belongs to timeout group 2 when IMMED is zero. The group 2 timeout value is only for Initiator information. The Logical Unit shall not time group 2 timeout commands. Execution shall continue until completion.

When the IMMED is set to one, status shall be returned within a Group 1 timeout.

6.10.5 Error Reporting

When the command operation began with the CDB IMMED bit set to one, it is possible that a deferred error may be reported in some future command.

Table 301 describes errors that may occur during the operation of the Command or that may cause a CHECK CONDITION status to be reported.

Table 301 – LOAD/UNLOAD MEDIUM Command Errors

Error	Reference	May be Deferred
Unit Attention conditions	Table F.1	
CDB or parameter list validation errors	Table F.2	
Readiness errors	Table F.3	
Hardware failures	Table F.8	√

6.11 MECHANISM STATUS Command

6.11.1 Introduction

The Mechanism Status command requests that the Logical Unit respond with the current status of the device, including any Changer Mechanism that adheres to this standard. This command is intended to provide information to the Initiator about the current operational state of the Logical Unit. The Logical Unit takes operational direction from both the Initiator and the user. Movement of media in/out of the Logical Unit as well as Play operations may be due to external controls or Initiator commands. This command provides a method that allows the Initiator to know what has transpired with the changer mechanism.

Table 302 shows the features associated with this command.

Table 302 – Features Associated with the MECHANISM STATUS Command

Feature Number	Feature Name	Command Requirement
0003h	Removable Medium	Mandatory
0102h	Embedded Media Changer	Mandatory

NOTE 1: The command requirement is valid only when the feature is current.

6.11.2 The CDB and its Parameters

The MECHANISM STATUS CDB is shown in Table 303.

Table 303 – MECHANISM STATUS CDB

Byte	Bit	7	6	5	4	3	2	1	0
0		Operation code (BDh)							
1		Reserved							
2		Reserved							
3		Reserved							
4		Reserved							
5		Reserved							
6		Reserved							
7		Reserved							
8	(MSB)	Allocation Length							
9		(LSB)							
10		Reserved							
11		Control							

The Allocation Length field specifies the maximum length, in bytes, of the Mechanism Status Parameter list that shall be transferred from the Logical Unit to the Initiator. An Allocation Length field of zero indicates that no data shall be transferred. This condition shall not be considered an error.

6.11.3 Command Execution

6.11.3.1 Mechanism Status Parameter List

The Mechanism Status Parameter list returned contains a header followed by zero or more fixed-length Slot Tables (Table 304). If the Logical Unit does not support the changer commands, then the number of slot tables returned to the Initiator should be zero.

Table 304 – Mechanism Status Parameter List Format

Bit	7	6	5	4	3	2	1	0
Byte								
0 – 7	Mechanism Status Header							
8 – n	Slot Tables							

The Mechanism Status Header format is shown in Table 305.

Table 305 – Mechanism Status Header

Bit	7	6	5	4	3	2	1	0
Byte								
0	Fault	Changer State		Current Slot (Low order 5 bits)				
1	Mechanism State			Door open	Reserved	Current Slot (High order 3 bits)		
2	(MSB)	Current LBA						
3								
4								
5	Number of Slots Available							
6	(MSB)	Length of Slot Tables						
7								

The Fault bit indicates that the changer failed to complete the operation reported in the Changer State field.

The Changer State field (Table 306) indicates the current state of the changer.

Table 306 – Changer State Field

Changer State	Definition
0h	Ready
1h	Load in Progress
2h	Unload in Progress
3h	Initializing

The Current Slot field (an 8-bit field) indicates the Current Slot selected. Changers compatible with a bootable device specification should always initialize (Load) Slot zero on power-on reset or hard reset. This value shall only be changed when a LOAD/UNLOAD command is processed. Operations initiated by a user shall not cause this value to change. If the Logical Unit is not a changer, then this field is reserved.

The Mechanism State field (Table 307) encodes the current operation of mechanism.

Table 307 – Mechanism State Field

Mechanism State	Definition
0h	Idle
1h	Playing (Audio or Data)
2h	Scanning
3h	Active with Initiator, Composite or Other Ports in use (i.e., READ)
4h-6h	Reserved
7h	No State Information Available

The Slot Table response data format is defined in Table 308. Each slot shall respond with the status defined.

The Door open bit, when set to one, indicates that the Door(s) or Tray(s) is open or the magazine is not present. If the Logical Unit does not have either a tray or a door, this bit shall be set to zero.

The Current LBA value returns the location that was last used while reading or playing. Once a Read or Play operation has been completed the value of this field may be undefined. While a Read or Play is in progress this field shall contain the LBA of the current block being processed.

The Number of Slots Available field indicates the number of slots available. The maximum number of slots is 255.

The Length of Slot Tables field specifies the length in bytes of the all the slot information that follows (e.g. for a 2 slot Logical Unit this value is 8). The Slot Table format is shown in Table 308.

Table 308 – Slot Table Format

Bit	7	6	5	4	3	2	1	0
Byte								
0	Disc Present	Reserved	Reserved	Reserved	Reserved	Reserved	Reserved	Change
1	Reserved						CWP_V	CWP
2	Reserved							
3	Reserved							

The Disc Present bit indicates that there is a Disc in this slot. The reporting of this information is optional after a reset or Disc change. If this capability is not supported, the bit shall be set to one after a reset condition or when a medium has been changed. When the Logical Unit is given a load command for a slot that contains no Disc, the bit corresponding to that slot shall then contain a zero for any following response.

The Change bit indicates that the Disc in that slot has been changed since the last time the disc was loaded. The Change bit is mandatory.

CWP_V, if set to one, indicates that the Media Cartridge Write Protection (CWP) of the Cartridge in that slot has been checked and CWP bit is valid. If CWP_V is zero, the CWP bit is invalid.

CWP, if set to 1, indicates that the CWP status is active on the Cartridge. If CWP_V is set to 0, CWP bit is invalid and shall be set to zero.

6.11.4 Timeouts

The MECHANISM STATUS command belongs to timeout group 1. If the command is terminated with CHECK CONDITION status due to a timeout, sense bytes SK/ASC/ASCQ shall be set to UNIT ATTENTION/INSUFFICIENT TIME FOR OPERATION.

6.11.5 Error Reporting

Recommended error reporting for the MECHANISM STATUS command is defined in Table 309.

Table 309 – Recommended errors for Mechanism Status Command

Error	Reference
Unit Attention conditions	Table F.1
CDB or parameter list validation errors	Table F.2

6.12 MODE SELECT (10) Command

6.12.1 Introduction

The MODE SELECT (10) command provides a means for the Initiator to specify medium, Logical Unit, or peripheral device parameters. Initiators should issue MODE SENSE (10) prior to each MODE SELECT (10) to determine supported mode pages, mode page lengths, and current settings.

Table 310 shows the features associated with the MODE SELECT command.

Table 310 – Features Associated with the Mode Select Command

Feature Number	Feature Name	Command Requirement
0001h	Core Feature	Mandatory

The MODE SELECT (10) command is described in SPC-3.

See clause 7 for detailed descriptions of mode pages, parameters and formats.

6.12.2 Timeouts

The MODE SELECT (10) command belongs to timeout group 1. If the command is terminated with CHECK CONDITION status due to a timeout, sense bytes SK/ASC/ASCQ shall be set to UNIT ATTENTION/INSUFFICIENT TIME FOR OPERATION.

6.12.3 Error Reporting

Recommended error reporting for the MODE SELECT (10) command is defined in Table 311.

Table 311 – Recommended errors for Mode Select (10) Command

Error	Reference
Unit Attention conditions	Table F.1
CDB or parameter list validation errors	Table F.2

6.13 MODE SENSE (10) Command

6.13.1 Introduction

The MODE SENSE (10) command provides a means for the Initiator to specify medium, Logical Unit, or peripheral device parameters. Initiators should issue MODE SENSE (10) prior to each MODE SELECT (10) to determine supported mode pages, mode page lengths, and current settings.

Table 312 shows the features associated with the MODE SENSE command.

Table 312 – Features Associated with the Mode Sense Command

Feature Number	Feature Name	Command Requirement
0001h	Core Feature	Mandatory

The MODE SELECT (10) command is described in SPC-3.

See clause 7 for detailed descriptions of mode pages, parameters and formats.

6.13.2 Timeouts

The MODE SENSE (10) command belongs to timeout group 1. If the command is terminated with CHECK CONDITION status due to a timeout, sense bytes SK/ASC/ASCQ shall be set to UNIT ATTENTION/INSUFFICIENT TIME FOR OPERATION.

6.13.3 Error Reporting

Recommended error reporting for the MODE SENSE (10) command is defined in Table 313.

Table 313 – Recommended errors for Mode Sense (10) Command

Error	Reference
Unit Attention conditions	Table F.1
CDB or parameter list validation errors	Table F.2

6.14 PAUSE/RESUME Command

6.14.1 Introduction

The PAUSE/RESUME command requests that the Logical Unit stop or restart an audio playback operation. This command is used with PLAY AUDIO commands that are executing in immediate mode.

Table 314 shows the Features associated with the PAUSE/RESUME command.

Table 314 – Features Associated with the PAUSE/RESUME Command

Feature Number	Feature Name	Command Requirement
0103h	CD Audio External Play, version 0	Mandatory
NOTE: The command requirement is valid only when the feature is current.		

6.14.2 The CDB and Its Parameters

The PAUSE/RESUME CDB is defined in Table 315.

Table 315 – Pause/Resume CDB

Bit	7	6	5	4	3	2	1	0
Byte								
0	OPERATION CODE (4Bh)							
1	Reserved							
2	Reserved							
3	Reserved							
4	Reserved							
5	Reserved							
6	Reserved							
7	Reserved							
8	Reserved							Resume
9	Control							

If the Resume bit is set to zero (Pause), the Logical Unit shall play (or scan) the current block, save the address of the next block, mute the audio outputs, and enter the hold track state.

If the Resume bit is set to one, the Logical Unit shall restore play at the saved address and restore audio outputs to conditions as specified by the CD Audio Control Page (see 7.5).

6.14.3 Command Execution

6.14.3.1 Pause

If audio play (or scan) is unable to be paused, (i.e., no audio play or scan operation has been requested, or the requested audio play or scan operation has been completed), the command is terminated with CHECK CONDITION status and SK/ASC/ASCQ values shall be set to ILLEGAL REQUEST/ COMMAND SEQUENCE ERROR. It shall not be considered an error to request a Pause when a pause is already in effect.

6.14.3.2 Resume

If an audio play (or scan) operation is unable to be resumed, the command shall be terminated with CHECK CONDITION status and SK/ASC/ASCQ values shall be set to ILLEGAL REQUEST/ COMMAND SEQUENCE ERROR. It shall not be considered an error to request a Resume when a play (or scan) operation is in progress.

If audio play is in progress due to PLAY AUDIO (10), PLAY AUDIO (12), or PLAY AUDIO MSF, then audio play shall be continued from the pause location for the range originally requested. If a SCAN is in progress and a resume is requested, the play shall continue until the end of audio data.

6.14.4 Timeouts

The PAUSE/RESUME command belongs to timeout group 1. If the command is terminated with CHECK CONDITION status due to a timeout, sense bytes SK/ASC/ASCQ shall be set to NOT READY/INSUFFICIENT TIME FOR OPERATION.

6.14.5 Error Reporting

Recommended error reporting for the PAUSE/RESUME command is defined in Table 316.

Table 316 – Recommended errors for PAUSE/RESUME Command

Error	Reference
Unit Attention conditions	Table F.1
CDB or parameter list validation errors	Table F.2
General media access errors	Table F.5
Hardware failures	Table F.8

6.15 PLAY AUDIO (10) Command

6.15.1 Introduction

The PLAY AUDIO (10) command requests that the Logical Unit begin an audio playback operation. The command function and the output of audio signals shall be as specified by the settings of the CD Audio Control Page (see 7.5).

Table 317 shows the Features associated with the PLAY AUDIO (10) command.

Table 317 – Features Associated with the PLAY AUDIO (10) Command

Feature Number	Feature Name	Command Requirement
0103h	CD Audio External Play	Mandatory
NOTE 1: The command requirement is valid only when the feature is current.		

6.15.2 The CDB and Its Parameters

6.15.2.1 The CDB

The PLAY AUDIO (10) CDB is shown in Table 318.

Table 318 – PLAY AUDIO (10) CDB

Byte	Bit	7	6	5	4	3	2	1	0
0		Operation Code (45h)							
1		Reserved							RelADR
2	(MSB)	Starting Logical Block Address							
3									
4									
5									
6		Reserved							
7	(MSB)	Play Length							
8									
9		Control							

6.15.2.2 RelAdr

The RelAdr bit shall be set to zero. Mmdevices do not support relative addressing.

6.15.2.3 Starting Logical Block Address

The Starting Logical Block Address field specifies the logical block that the audio playback operation shall begin. PLAY AUDIO commands with a starting logical block address of FFFF FFFFh shall implement audio play from the current location of the optics. If the starting address is not found, the command shall be terminated with CHECK CONDITION status and SK/ASC/ASCQ values shall be set to ILLEGAL REQUEST/LOGICAL BLOCK ADDRESS OUT OF RANGE.

6.15.2.4 Play Length

The Play Length field specifies the number of contiguous logical blocks that shall be played. A Play Length field of zero indicates that no audio operation shall occur. This condition shall not be considered an error. If the logical block address requested is not within an audio track and the Play Length is non-zero, the command shall be terminated with CHECK CONDITION status and SK/ASC/ASCQ values shall be set to ILLEGAL REQUEST/ILLEGAL MODE FOR THIS TRACK.

6.15.3 Command Execution

If the CD Sub-channel mode type (data vs. audio) is other than audio or changes within the transfer length the command shall be terminated with CHECK CONDITION status and SK/ASC/ASCQ values

shall be set to ILLEGAL REQUEST/END OF USER AREA ENCOUNTERED ON THIS TRACK.

The PLAY AUDIO and SCAN commands continue to play while the logical unit may process other commands. Some commands may be accepted without disrupting the audio operations, while others cause the Play operation to stop.

The Logical Unit shall accept and perform the commands as specified. If a PLAY or SCAN operation is executing such that the IMMEDIATE bit in the CD Audio Control Mode Page was set to one when the command started, execution of a new command takes precedence. When the new command may be processed to completion without disturbing execution of the PLAY or SCAN, it shall be done. Otherwise, the PLAY or SCAN shall be terminated in order that the new command may be performed. The following commands shall be performed without disturbing the PLAY or SCAN command:

- a) REQUEST SENSE
- b) READ SUB-CHANNEL, current position
- c) PAUSE/RESUME
- d) INQUIRY
- e) READ CAPACITY

All other commands that may effect the termination of PLAY or SCAN are implementation specific.

6.15.4 Timeouts

The PLAY AUDIO (10) command belongs to timeout group 1. When the IMMEDIATE bit in the CD Audio Control Mode Page is set to one, timeouts are not permitted. Otherwise, if the command is terminated with CHECK CONDITION status due to a timeout, sense bytes SK/ASC/ASCQ shall be set to NOT READY/ INSUFFICIENT TIME FOR OPERATION.

6.15.5 Error Reporting

Recommended error reporting for the PLAY AUDIO (10) command is defined in Table 319.

Table 319 – Recommended errors for PLAY AUDIO (10) Command

Error	Reference	May be Deferred
Unit Attention conditions	Table F.1	
CDB or parameter list validation errors	Table F.2	
Readiness errors	Table F.3	
General media access errors	Table F.5	√
Hardware failures	Table F.8	√

6.16 PLAY AUDIO (12) Command

6.16.1 Introduction

The PLAY AUDIO (12) command requests that the Logical Unit begin an audio playback operation. The command function and the output of audio signals shall be as specified by the settings of the CD Audio Control Page (see 7.5).

Table 320 shows the Features associated with the PLAY AUDIO (12) command.

Table 320 – Features Associated with the PLAY AUDIO (12) Command

Feature Number	Feature Name	Command Requirement
0103h	CD Audio External Play	Optional
NOTE 1: The command requirement is valid only when the feature is current.		

6.16.2 The CDB and Its Parameters

The PLAY AUDIO (12) CDB is shown in Table 321.

Table 321 – PLAY AUDIO (12) CDB

Byte	Bit	7	6	5	4	3	2	1	0
0		OPERATION CODE (A5h)							
1		Reserved							RelADR
2	(MSB)	Logical Block Address							
3									
4									
5									
6	(MSB)	Play Length							
7									
8									
9									
10		Reserved							
11		Control							

See PLAY AUDIO (10) command for CDB field descriptions.

6.16.3 Command Execution

See PLAY AUDIO (10) command for the description of command execution.

6.16.4 Timeouts

The PLAY AUDIO (12) command belongs to timeout group 1. When the IMMED bit in the CD Audio Control Mode Page is set to one, timeouts are not permitted. Otherwise, if the command is terminated with CHECK CONDITION status due to a timeout, sense bytes SK/ASC/ASCQ shall be set to NOT READY/ INSUFFICIENT TIME FOR OPERATION.

6.16.5 Error Reporting

Recommended error reporting for the PLAY AUDIO (12) command is defined in Table 322.

Table 322 – Recommended errors for PLAY AUDIO(12) Command

Error	Reference	May be Deferred
Unit Attention conditions	Table F.1	
CDB or parameter list validation errors	Table F.2	
Readiness errors	Table F.3	
General media access errors	Table F.5	√
Hardware failures	Table F.8	√

6.17 PLAY AUDIO MSF Command

6.17.1 Introduction

The PLAY AUDIO MSF command requests that the Logical Unit begin an audio playback operation. The command function and the output of audio signals shall be as specified by the settings of the CD Audio Control Page (see 7.5).

Table 323 shows the Features associated with the PLAY AUDIO MSF command.

Table 323 – Features Associated with the PLAY AUDIO MSF Command

Feature Number	Feature Name	Command Requirement
0103h	CD Audio External Play	Mandatory
NOTE 1: The command requirement is valid only when the feature is current.		

6.17.2 The CDB and its Parameters

6.17.2.1 The CDB

The PLAY AUDIO MSF CDB is shown in Table 324.

Table 324 – PLAY AUDIO MSF CDB

Byte	Bit	7	6	5	4	3	2	1	0
0	OPERATION CODE (47h)								
1	Reserved								
2	Reserved								
3	Starting M Field								
4	Starting S Field								
5	Starting F Field								
6	Ending M Field								
7	Ending S Field								
8	Ending F Field								
9	Control								

6.17.2.2 Starting M Field, Starting S Field, Starting F Field

The Starting M Field, the Starting S Field, and the Starting F Field specify the absolute MSF address that the audio play operation shall begin.

6.17.2.3 Ending M Field, Ending S Field, Ending F Field

The Ending M Field, the Ending S Field, and the Ending F Field specify the absolute MSF address where the audio play operation shall end. All contiguous audio sectors between the starting and the ending MSF address shall be played.

If the Starting Minutes, Seconds, and Frame Fields are set to FFh, the Starting address is taken from the Current Optical Head location. This allows the Audio Ending address to be changed without interrupting the current playback operation.

A starting MSF address equal to an ending MSF address causes no audio play operation to occur. This shall not be considered an error. If the starting MSF address is greater than the ending MSF address, the command shall be terminated with CHECK CONDITION status and SK/ASC/ASCQ values shall be set to ILLEGAL REQUEST/INVALID FIELD IN CDB.

If the starting address is not found the command shall be terminated with CHECK CONDITION status and SK/ASC/ASCQ values shall be set to ILLEGAL REQUEST/LOGICAL BLOCK ADDRESS OUT OF RANGE. If the address is not within an audio track the command shall be terminated with CHECK CONDITION status and SK/ASC/ASCQ values shall be set to ILLEGAL REQUEST/ILLEGAL

MODE FOR THIS TRACK or ILLEGAL REQUEST/INCOMPATIBLE MEDIUM INSTALLED. If a not ready condition exists, the command shall be terminated with CHECK CONDITION status and SK/ASC/ASCQ shall be set to the appropriate values.

6.17.3 Command Execution

See PLAY AUDIO (10) command for the description of command execution.

6.17.4 Timeouts

The PLAY AUDIO (10) command belongs to timeout group 1. When the IMMED bit in the CD Audio Control Mode Page is set to one, timeouts are not permitted. Otherwise, if the command is terminated with CHECK CONDITION status due to a timeout, sense bytes SK/ASC/ASCQ shall be set to NOT READY/ INSUFFICIENT TIME FOR OPERATION.

6.17.5 Error Reporting

Recommended error reporting for the PLAY AUDIO MSF command is defined in Table 325.

Table 325 – Recommended errors for PLAY AUDIO MSF Command

Error	Reference	May be Deferred
Unit Attention conditions	Table F.1	
CDB or parameter list validation errors	Table F.2	
Readiness errors	Table F.3	
General media access errors	Table F.5	√
Hardware failures	Table F.8	√

6.18 PREVENT ALLOW MEDIUM REMOVAL Command

6.18.1 Introduction

The PREVENT/ALLOW MEDIUM REMOVAL Command requests that the Logical Unit enable or disable the removal of the medium in the Logical Unit. The Logical Unit shall not allow medium removal if any Initiator currently has medium removal prevented. The method of prevention of medium removal is vendor specific.

SPC-3 describes a PREVENT ALLOW MEDIUM REMOVAL command, however, the SPC-3 description does not apply to MM devices.

Table 326 shows the Features associated with the PREVENT ALLOW MEDIUM REMOVAL command.

Table 326 – Features Associated with the PREVENT ALLOW MEDIUM REMOVAL Command

Feature Number	Feature Name	Command Requirement
0002h	Morphing	Mandatory
0003h	Removable Medium	Mandatory

6.18.2 The CDB and its Parameters

The PREVENT ALLOW MEDIUM REMOVAL CDB is shown in Table 327.

Table 327 – PREVENT ALLOW MEDIUM REMOVAL CDB

Bit	7	6	5	4	3	2	1	0
0	Operation Code (1Eh)							
1	Reserved							
2	Reserved							
3	Reserved							
4	Reserved						Persistent	Prevent
5	Control							

The Logical Unit maintains two separate Prevent states: Prevent and Persistent Prevent as described in 4.1.7. The Persistent and Prevent bits are used to independently select values for these states. See Table 328.

Table 328 – State Selection

Persistent	Prevent	Meaning
0	0	Prevent State shall be cleared (Unlocked)
0	1	Prevent State shall be set (Locked)
1	0	Persistent Prevent State shall be cleared (Persistent Allow)
1	1	Persistent Prevent State shall be set (Persistent Prevent)

The recommended default state at power-on or hard reset is Prevent State cleared and Persistent Prevent State cleared.

6.18.3 Command Execution

6.18.3.1 Overview

The selected state begins upon successful completion of the PREVENT ALLOW MEDIUM REMOVAL command.

6.18.3.2 Persistent Prevent State

Upon entering the Persistent Prevent state, the logical unit shall disable any eject mechanisms, and

all media after initial media spin up shall remain locked in the Logical Unit until the Initiator issues an eject request, or the Persistent Prevent status is reset and the hardware eject mechanism again becomes available.

The Persistent Prevent status shall be reset upon receipt of a PREVENT/ALLOW MEDIUM REMOVAL command (from the same Initiator that originally set the Persistent Prevent state) with the Persistent bit set and the Prevent bit cleared, a bus reset, or a power reset condition.

Upon insertion of new media, under Persistent Prevent conditions, the logical unit eject controls shall remain functional up until the Logical Unit generates or reports a New Media event as defined in the Media Events section. After this event has been generated or reported, the media shall remain locked as defined above. The logical unit is allowed to morph from the no medium present state to the medium present state without explicit direction from the Initiator.

The logical unit shall not report a New Media Event if the medium is removed between the generation of the Event and the next GET EVENT/STATUS NOTIFICATION command issued.

The Persistent Prevent state shall not prevent an eject request from the Initiator from succeeding.

6.18.3.3 Prevent State

The Prevent State (Locked) is entered upon successful completion of the PREVENT/ALLOW MEDIUM REMOVAL command where Prevent State is set.

The prevention of medium removal for the Logical Unit shall terminate:

1. After the Initiator has issued a PREVENT/ALLOW MEDIUM REMOVAL command clearing Prevent State and the Logical Unit has successfully performed a flush cache operation; or
2. Upon a Hard Reset condition; or
3. Upon a DEVICE RESET in an ATAPI environment; or

While a prevention of medium removal condition is in effect the Logical Unit shall inhibit mechanisms that normally allow removal of the medium by an operator. This is also the case for changers.

Unlocked is the recommended default state of the Logical Unit at power on.

This command affects the actions of the START/STOP UNIT command (6.45) and other mechanisms (e.g. manual ejection / media removal systems).

Table 329 – Actions for Lock/Unlock/Eject

Operation	Current Prevent State	No Media Present	Media Present and READY
Unlock	Unlocked	No error	No error.
	Locked	No error, medium may be inserted.	No error, medium may be removed.
Lock	Unlocked	No Error, media insertion is not permitted	No Error, media to be removal is not permitted
	Locked	No error	No error
Start/Stop Unit with Start=0 and LoEj=1	Unlocked	No error. Media mount mechanism is opened.	No error. Media is ejected.
	Locked	CHECK CONDITION, SK/ASC/ASCQ = NOT READY/MEDIUM REMOVAL PREVENTED	CHECK CONDITION, SK/ASC/ASCQ = ILLEGAL REQUEST/MEDIUM REMOVAL PREVENTED
Manual Eject	Unlocked	Media mount mechanism is opened.	Media is ejected.
	Locked	No visible operation occurs.	No visible operation occurs.

6.18.4 Timeouts

The PREVENT ALLOW MEDIUM REMOVAL command belongs to timeout group 1. If the command is terminated with CHECK CONDITION status due to a timeout, sense bytes SK/ASC/ASCQ shall be set to UNIT ATTENTION/INSUFFICIENT TIME FOR OPERATION.

6.18.5 Error Reporting

Recommended error reporting for the PREVENT ALLOW MEDIUM REMOVAL command is defined in Table 330.

Table 330 – Recommended errors for PREVENT ALLOW MEDIUM REMOVAL Command

Error	Reference
Unit Attention conditions	Table F.1
CDB or parameter list validation errors	Table F.2
Hardware failures	Table F.8

6.19 READ (10) Command

6.19.1 Introduction

The READ (10) command requests that the Logical Unit transfer data to the Initiator. The most recent data value written in the addressed logical block region shall be returned.

Table 331 shows the Features associated with the READ (10) command.

Table 331 – Features Associated with the READ (10) Command

Feature Number	Feature Name	Command Requirement
0010h	Random Readable	Mandatory
001Dh	MultiRead	Mandatory
001Fh	DVD Read	Mandatory
0028h	MRW	Mandatory
NOTE: The command requirement is valid only when the feature is current.		

6.19.2 The CDB and Its Parameters

6.19.2.1 The CDB

The READ (10) CDB is shown in Table 332.

Table 332 – READ (10) CDB

Bit	7	6	5	4	3	2	1	0
Byte								
0	OPERATION CODE (28h)							
1	Reserved			DPO	FUA	Reserved		RelAdr
2	(MSB) Logical Block Address (LSB)							
3								
4								
5								
6	Reserved							
7	(MSB) Transfer Length (LSB)							
8								
9	Control							

6.19.2.2 DPO

The Disable Page Out (DPO) bit is not used by MM Logical Units and shall be set to zero.

6.19.2.3 FUA

A Force Unit Access (FUA) bit of one indicates that the Logical Unit shall access the media in performing the command. The READ (10) command shall access the specified logical blocks from the media (i.e., the data is not directly retrieved from the cache). In the case where the cache contains a more recent version of a logical block than the media, the logical block shall first be written to the media.

An FUA bit of zero indicates that the Logical Unit may satisfy the command by accessing the cache memory. For read operations, any logical blocks that are contained in the cache memory may be transferred to the Initiator directly from the cache memory.

6.19.2.4 RelAdr

The Relative Address (RelAdr) bit is not used by MM Logical Units and shall be set to zero.

6.19.2.5 Logical Block Address

The Logical Block Address field contains the LBA of the first block from which data shall be returned.

If the Logical Block Address is beyond the range of recorded data, the Logical Unit shall terminate the command with CHECK CONDITION status and SK/ASC/ASCQ values shall be set to ILLEGAL REQUEST/LOGICAL BLOCK ADDRESS OUT OF RANGE.

6.19.2.6 Transfer Length

The Transfer Length field specifies the number of contiguous logical blocks of data that shall be transferred. A Transfer Length of zero indicates that no logical blocks shall be transferred. This condition shall not be considered an error. Any other value indicates the number of logical blocks that shall be transferred.

6.19.3 Command Execution

The block size for the READ (10) command shall be 2 048 bytes. If the block size of a requested sector is not 2 048, the Logical Unit shall:

1. Terminate the command with CHECK CONDITION status,
2. Set sense bytes SK/ASC/ASCQ to ILLEGAL REQUEST/ILLEGAL MODE FOR THIS TRACK,
3. The ILI bit in sense data byte 2 shall be set to one, and
4. Set the sense Information bytes to the LBA of the sector.

Any read by the Initiator to a Logical Block with a Title Key present in the sector (DVD-ROM Media Only), when the Authentication Success Flag (ASF) is set to zero shall be blocked. The command shall be terminated with CHECK CONDITION status and SK/ASC/ASCQ values shall be set to ILLEGAL REQUEST/READ OF SCRAMBLED SECTOR WITHOUT AUTHENTICATION.

If the currently mounted medium is CD-RW with MRW formatting operating in background, DVD+RW with basic formatting operating in background, or DVD+RW with MRW formatting operating in background, the READ (10) command operation shall be as follows:

- If any of the sectors within the range specified by the CDB are in a blank area of the media where format writing has not yet occurred, the blank sectors shall not be read and the command shall fabricate and return data as if the sectors had been format written.
- If all of the sectors within the range specified by the CDB are in an area of the media where format writing has occurred, the command shall operate normally.

When Restricted Overwrite method is performed (Restricted Overwrite Feature (0026h) or Rigid Restricted Overwrite Feature (002Ch)), READ (10) command or READ (12) command shall be performed normally after data in buffer is written on the disc.

If Enhanced Defect Reporting Feature (0029h) is current, the logical unit shall follow the setting of the PER bit and the EMCDR field in Read/Write Error Recovery Parameters Mode Page (01h). See clause 4.6, "Logical unit assisted software defect management model".

6.19.4 Timeouts

The READ (10) command belongs to timeout group 1. If the command is terminated with CHECK CONDITION status due to a timeout, sense bytes SK/ASC/ASCQ shall be set to UNIT ATTENTION/INSUFFICIENT TIME FOR OPERATION.

6.19.5 Error Reporting

Recommended error reporting for the READ (10) command is defined in Table 333.

Table 333 – Recommended errors for READ (10) Command

Error	Reference
Unit Attention conditions	Table F.1
CDB or parameter list validation errors	Table F.2
Readiness errors	Table F.3
General media access errors	Table F.5
Read errors	Table F.6
Hardware failures	Table F.8

6.20 READ (12) Command

6.20.1 Introduction

The READ (12) command requests that the Logical Unit transfer data to the Initiator. The most recent data value written in the addressed logical block shall be returned.

Table 334 shows the Features associated with the READ (12) command.

Table 334 – Features Associated with the READ (12) Command

Feature Number	Feature Name	Command Requirement
001Fh	DVD Read	Mandatory
0028h	MRW	Mandatory
0107h	Real-time Streaming	Mandatory
NOTE 1: The command requirement is valid only when the feature is current.		

6.20.2 The CDB and Its Parameters

6.20.2.1 The CDB

The READ (12) CDB is shown in Table 335.

Table 335 – READ (12) CDB

Bit	7	6	5	4	3	2	1	0
Byte 0	OPERATION CODE (A8h)							
1	Reserved			DPO	FUA	Reserved		RELADR
2	(MSB) Logical Block Address (LSB)							
3								
4								
5								
6								
7	(MSB) Transfer Length (LSB)							
8								
9								
10								
11	Control							

6.20.2.2 DPO

The Disable Page Out (DPO) bit is not used by MM Logical Units and shall be set to zero.

6.20.2.3 FUA

A Force Unit Access (FUA) bit of one indicates that the Logical Unit shall access the media in performing the command. The READ (12) command shall access the specified logical blocks from the media (i.e., the data is not directly retrieved from the cache). In the case where the cache contains a more recent version of a logical block than the media, the logical block shall first be written to the media.

An FUA bit of zero indicates that the Logical Unit may satisfy the command by accessing the cache memory. For read operations, any logical blocks that are contained in the cache memory may be transferred to the Initiator directly from the cache memory.

6.20.2.4 RelAdr

The Relative Address (RELADR) bit is not used by MM Logical Units and shall be set to zero.

6.20.2.5 Logical Block Address

The Logical Block Address field contains the LBA of the first block from which data shall be returned. If the Logical Block Address is outside the range of recorded data, the Logical Unit shall terminate the command with CHECK CONDITION status and SK/ASC/ASCQ values shall be set to ILLEGAL REQUEST/LOGICAL BLOCK ADDRESS OUT OF RANGE.

6.20.2.6 Transfer Length

The Transfer Length field specifies the number of contiguous logical blocks of data that shall be transferred. A Transfer Length of zero indicates that no logical blocks shall be transferred. This condition shall not be considered an error. Any other value indicates the number of logical blocks that shall be transferred.

6.20.2.7 Streaming

The Streaming bit of one specifies that the Stream playback operation shall be used for the command (see 4.7.2). The Streaming bit of zero specifies that the conventional READ operation shall be used for the command. If the Streaming bit is set to one, the cache control Mode parameter may be ignored.

If Streaming bit is set to 1 and if the logical unit supports Group3 timeout and if G3Enable bit in Timeout & Protect Mode Page (1Dh) is set to 1, the logical unit shall terminate this command within Group 3 timeout. If G3Enable bit is set to 0, this command is categorized as Group 1 timeout.

When the Streaming bit is set to one, the FUA bit shall be set to zero. If the Streaming bit is set to one and the FUA bit is set to one, the Logical Unit shall terminate the command with CHECK CONDITION status and SK/ASC/ASCQ values shall be set to ILLEGAL REQUEST/INVALID FIELD IN CDB.

6.20.3 Command Execution

The block size for the READ (12) command shall be 2 048 bytes. If the block size of a requested sector is not 2 048, the Logical Unit shall:

1. Terminate the command with CHECK CONDITION status,
2. Set sense bytes SK/ASC/ASCQ to ILLEGAL REQUEST/ILLEGAL MODE FOR THIS TRACK,
3. The ILI bit in sense data byte 2 shall be set to one, and
4. Set the sense Information bytes to the LBA of the sector.

Any read by the Initiator to a Logical Block with a Title Key present in the sector (DVD-ROM Media Only), when the Authentication Success Flag (ASF) is set to zero shall be blocked. The command shall be terminated with CHECK CONDITION status and SK/ASC/ASCQ values shall be set to ILLEGAL REQUEST/READ OF SCRAMBLED SECTOR WITHOUT AUTHENTICATION.

If the currently mounted medium is CD-RW with MRW formatting operating in background, DVD+RW with basic formatting operating in background, or DVD+RW with MRW formatting operating in background, the READ (12) command operation shall be as follows:

- a) If any of the sectors within the range specified by the CDB are in a blank area of the media where format writing has not yet occurred, the blank sectors shall not be read and the command shall fabricate and return data as if the sectors had been format written.
- b) If all of the sectors within the range specified by the CDB are in an area of the media where format writing has occurred, the command shall operate normally.

6.20.4 Timeouts

The READ (12) command belongs to timeout group 1. If the command is terminated with CHECK CONDITION status due to a timeout, sense bytes SK/ASC/ASCQ shall be set to UNIT ATTENTION/INSUFFICIENT TIME FOR OPERATION.

If the logical unit supports Group3 time-out and the G3Enable bit in Time-out & Protect Mode Page (1Dh) is set to 1, READ (12) with Streaming = 1 is re-categorized as Group 3 time-out. Refer to 4.1.8.5.

6.20.5 Error Reporting

Recommended error reporting for the READ (12) command is defined in Table 336.

Table 336 – Recommended errors for READ (12) Command

Error	Reference
Unit Attention conditions	Table F.1
CDB or parameter list validation errors	Table F.2
Readiness errors	Table F.3
General media access errors	Table F.5
Read errors	Table F.6
Hardware failures	Table F.8

6.21 READ BUFFER Command

6.21.1 Introduction

The READ BUFFER command is used in conjunction with the WRITE BUFFER command as a diagnostic function for testing memory in the device and the integrity of the service delivery subsystem. Execution of this command shall not alter the medium.

The READ BUFFER command is optional for all MM devices. The READ BUFFER command is not mandatory under any Feature defined in this standard.

The READ BUFFER command is described in SPC-3.

6.21.2 Timeouts

The READ BUFFER command belongs to timeout group 1. If the command is terminated with CHECK CONDITION status due to a timeout, sense bytes SK/ASC/ASCQ shall be set to UNIT ATTENTION/INSUFFICIENT TIME FOR OPERATION.

6.21.3 Error Reporting

Recommended error reporting for the READ BUFFER command is defined in Table 337.

Table 337 – Recommended errors for READ BUFFER Command

Error	Reference
Unit Attention conditions	Table F.1
CDB or parameter list validation errors	Table F.2

6.22 READ BUFFER CAPACITY Command

6.22.1 Introduction

During certain streamed write operations, the READ BUFFER CAPACITY command returns the Logical Unit's total length of buffer and its length of available buffer. The Logical Unit reports the length of the buffer during Track at Once Recording, Session at Once Recording, or Disc at once recording.

Table 338 shows the Features associated with the READ BUFFER CAPACITY command.

Table 338 – Features Associated with the READ BUFFER CAPACITY Command

Feature Number	Feature Name	Command Requirement
0107h	Real-time Streaming	Mandatory. Conditional for Block bit = 1.
NOTE 1: The command requirement is valid only when the feature is current.		

6.22.2 The CDB and Its Parameters

6.22.2.1 The CDB

The READ BUFFER CAPACITY CDB is shown in Table 339.

Table 339 – READ BUFFER CAPACITY CDB

Bit	7	6	5	4	3	2	1	0
0	Operation Code (5Ch)							
1	Reserved			Reserved				BLOCK
2	Reserved							
3	Reserved							
4	Reserved							
5	Reserved							
6	Reserved							
7	(MSB)	Allocation Length						(LSB)
8								
9	Control							

6.22.2.2 BLOCK

When the BLOCK bit is zero, the Initiator is requesting that buffer length information be reported as bytes. The BLOCK bit, if set to one, indicates that the Initiator is requesting buffer length information reported as blocks. If the Logical Unit does not support the case for Block = 1, the command shall be terminated with CHECK CONDITION status and sense bytes SK/ASC/ASCQ shall be set to ILLEGAL REQUEST/INVALID FIELD IN CDB.

6.22.2.3 Allocation Length

If Allocation Length is 12 or greater, the entire Buffer Capacity structure shall be returned. If Allocation Length is less than 12, the returned data shall be truncated to that length. An Allocation Length of zero is not an error.

6.22.3 Command Execution

6.22.3.1 Reporting Available Buffer in Bytes

If the Real-time Streaming Feature is present and current, the Logical Unit shall return the Buffer Capacity structure associated with Block = 0 (Table 340).

Table 340 – Buffer Capacity Structure, when Block = 0

Byte	Bit	7	6	5	4	3	2	1	0
0	(MSB)	Data Length							
1		(LSB)							
2	Reserved								
3	Reserved								
4	(MSB)	Length of the Buffer							
5									
6									
7		(LSB)							
8	(MSB)	Available Length of Buffer							
9									
10									
11		(LSB)							

The Data Length field defines the number of data bytes to be transferred by the Logical Unit. The Data Length value does not include the Data Length field itself.

The Length of Buffer indicates the whole capacity of the buffer in bytes.

The Available Length of Buffer indicates the length of unused area of the buffer in bytes. If the Real-time Streaming Feature is present, but not current, the contents of this field are not defined.

6.22.3.2 Reporting Available Buffer in Blocks

If the Real-time Streaming Feature is present and current, and the RBCB bit in the Feature Descriptor is set to one, the Logical Unit shall return the Buffer Capacity structure associated with Block = 1 (Table 341).

Table 341 – Buffer Capacity Structure, when Block = 1

Byte	Bit	7	6	5	4	3	2	1	0
0	(MSB)	Data Length							
1		(LSB)							
2	Reserved								
3	Reserved							Block	
4	Reserved								
5	Reserved								
6	Reserved								
7	Reserved								
8	(MSB)	Available Length of Buffer							
9									
10									
11		(LSB)							

The Data Length field defines the number of data bytes to be transferred by the Logical Unit. The Data Length value does not include the Data Length field itself.

The Available Length of Buffer indicates the length of unused area of the buffer in blocks. If the Real-time Streaming Feature is present, but not current, the contents of this field are not defined.

The Available Length of Buffer field indicates the number of blocks of buffer currently available to be written to by the Initiator. The Logical Unit shall be able to immediately accept at least this much data for writing. If the Available Length of Buffer becomes zero, the Logical Unit shall begin writing. The

Logical Unit may begin writing before the Available Length of Buffer reaches zero.

(Current Write Block Size in bytes)*(Number of buffer blocks available to receive Initiator data) shall be identical to Available Length of Buffer.

6.22.4 Timeouts

The READ BUFFER CAPACITY command belongs to timeout group 1. If the command is terminated with CHECK CONDITION status due to a timeout, sense bytes SK/ASC/ASCQ shall be set to UNIT ATTENTION/INSUFFICIENT TIME FOR OPERATION.

6.22.5 Error Reporting

Recommended error reporting for the READ BUFFER CAPACITY command is defined in Table 342.

Table 342 – Recommended errors for READ BUFFER CAPACITY Command

Error	Reference
Unit Attention conditions	Table F.1
CDB or parameter list validation errors	Table F.2

6.23 READ CAPACITY Command

6.23.1 Introduction

The READ CAPACITY command provides a means for the Initiator to request information regarding the capacity of media currently loaded into the Logical Unit. This capacity is reported with respect to reading operations. For capacity associated with writing operations, see 6.28, READ FORMAT CAPACITIES Command.

Table 343 shows the Features associated with the READ CAPACITY command.

Table 343 – Features Associated with the READ CAPACITY Command

Feature Number	Feature Name	Command Requirement
0010h	Random Readable	Mandatory
0020h	Random Writable	Mandatory
0025h	Write-Once	Mandatory
0026h	Restricted Overwrite	Mandatory
0027h	CD-RW CAV Write	Mandatory
0028h	MRW	Mandatory
002Ch	Rigid Restricted Overwrite	Mandatory

NOTE 1: The command requirement is valid only when the feature is current.

6.23.2 The CDB and Its Parameters

6.23.2.1 The CDB

The READ CAPACITY CDB is shown in Table 344.

Table 344 – READ CAPACITY CDB

Byte	Bit	7	6	5	4	3	2	1	0
0		OPERATION CODE (25h)							
1		Reserved							RelAdr=0
2	(MSB)	Logical Block Address=0000 0000h							
3									
4									
5	(LSB)								
6		Reserved							
7		Reserved							
8		Reserved							PMI=0
9		Control							

6.23.2.2 RelAdr

The RelAdr field is not used by MM Logical Units and shall be set to zero.

6.23.2.3 Logical Block Address

The Logical Block Address field is not used by MM Logical Units and shall be set to zero.

6.23.2.4 PMI

The PMI field is not used by MM Logical Units and shall be set to zero.

6.23.3 Command Execution

The Logical Unit shall respond to this command by returning eight bytes of READ CAPACITY response data. The format of response data is shown in Table 345.

Table 345 – READ CAPACITY Response Data

Bit	7	6	5	4	3	2	1	0
Byte								
0	Logical Block Address							
1								
2								
3								
4	Block Length in Bytes = 2 048d							
5								
6								
7								

The returned Logical Block Address is dependent upon media and format type. Table 346 shows the reporting for each MM case.

Table 346 – Logical Block Address Reporting

Media/Format	Logical Block Address
CD-MRW	When LBA Space bit of MRW Mode Page is set to 0, this field is set to the Method 3 address of the last block in the Defect Managed Area. When LBA Space bit is set to 1, this field is set to the address of the last block in the General Application Area. When the format is in progress, this field shall be the last addressable LBA when formatting is completed.
DVD+MRW	When LBA Space bit of MRW Mode Page is set to 0, this field is set to the address of the last block in the User Data Area. When LBA Space bit is set to 1, this field is set to the address of the last block in the General Application Area. When the format is in progress, this field shall be the last addressable LBA when formatting is completed.
CD, non-MRW formats	If the Start address of last recorded lead-out minus 1 is a run-out block, this value is the Start address of last recorded lead-out minus 2. Otherwise, this value is the Start address of last recorded lead-out minus 1. The Logical Address calculation shall be according to the addressing method of the track that immediately precedes the lead-out. If no complete session exists on the medium, this field shall be set to zero.
DVD, non-MRW formats	The last addressable user data block (= Last Recorded Address) in the last track of the last complete session.

In the case of MRW formats and DVD+RW, the Logical Block Address reported shall be the expected final value when BG formatting is in progress and not completed (i.e., when the READ DISC INFORMATION command response for BG format status is non-zero).

For all MM media and format types, the Block Length shall be reported, in bytes, as 2 048.

6.23.4 Timeouts

The READ CAPACITY command belongs to timeout group 1. If the command is terminated with CHECK CONDITION status due to a timeout, sense bytes SK/ASC/ASCQ shall be set to UNIT ATTENTION/INSUFFICIENT TIME FOR OPERATION.

6.23.5 Error Reporting

Recommended error reporting for the READ CAPACITY command is defined in Table 347.

Table 347 – Recommended errors for READ CAPACITY Command

Error	Reference
Unit Attention conditions	Table F.1
CDB or parameter list validation errors	Table F.2
Readiness errors	Table F.3
General media access errors	Table F.5
Read errors	Table F.6

6.24 READ CD Command

6.24.1 Introduction

The READ CD command provides a method for accessing most fields within any CD sector. This command has a large variety of execution outcomes due the numerous parameters.

Table 348 shows the Features associated with the READ CD command.

Table 348 – Features Associated with the READ CD Command

Feature Number	Feature Name	Command Requirement
001Dh	MultiRead	Mandatory
001Eh	CD Read	Mandatory
NOTE 1: The command requirement is valid only when the feature is current.		

6.24.2 The CDB and Its Parameters

6.24.2.1 The CDB

The READ CD CDB is shown in Table 349.

Table 349 – READ CD CDB

Bit	7	6	5	4	3	2	1	0
Byte								
0	Operation Code (BEh)							
1	Reserved			Expected Sector Type			DAP	RelAdr
2	(MSB) Starting Logical Block Address (LSB)							
3								
4								
5								
6								
6	(MSB) Transfer Length (LSB)							
7								
8								
9	Main Channel Selection Bits				C2 Error Information		Reserved	
	SYNC	Header Codes	User Data	EDC & ECC				
10	Reserved				Sub-channel Selection Bits			
11	Control							

6.24.2.2 Expected Sector Type

The Expected Sector Type field (Table 350) is used to restrict reading to a specific CD sector type. A transfer operation is terminated as soon as data is encountered that does not match one of those specified in the sector type field of the command. The sector/sectors that do not match shall not be transferred to the Initiator.

Table 350 – Expected Sector type field bit definitions

Sector Type	Definition	Description	Requirement
000b	All types	No checking of the data type is performed. If there is a transition between CD data and CD-DA data, the command shall be terminated with a CHECK CONDITION status and sense bytes SK/ASC/ASCQ shall be set to ILLEGAL REQUEST/ILLEGAL MODE FOR THIS TRACK.	Mandatory
001b	CD-DA	Only IEC 908 (CD-DA) sectors shall be returned. If any other sector type is encountered, the command shall be terminated with a CHECK CONDITION status and sense bytes SK/ASC/ASCQ shall be set to ILLEGAL REQUEST/ILLEGAL MODE FOR THIS TRACK.	Mandatory
010b	Mode 1	Only sectors with a user data field of 2 048 bytes shall be returned. If any other sector type is encountered, the command shall be terminated with a CHECK CONDITION status and sense bytes SK/ASC/ASCQ shall be set to ILLEGAL REQUEST/ILLEGAL MODE FOR THIS TRACK.	Mandatory
011b	Mode 2 formless	Only sectors with the expanded user data field (2 336 bytes) shall be returned. If any other sector type is encountered, the command shall be terminated with a CHECK CONDITION status and sense bytes SK/ASC/ASCQ shall be set to ILLEGAL REQUEST/ILLEGAL MODE FOR THIS TRACK.	Optional
100b	Mode 2 form 1	Only sectors that have a user data field of 2 048 bytes shall be returned. If any other sector type is encountered, the command shall be terminated with a CHECK CONDITION status and sense bytes SK/ASC/ASCQ shall be set to ILLEGAL REQUEST/ILLEGAL MODE FOR THIS TRACK.	Mandatory
101b	Mode 2 form 2	Only sectors that have a user data field of 2 324 bytes shall be returned. If any other sector type is encountered, the command shall be terminated with a CHECK CONDITION status and sense bytes SK/ASC/ASCQ shall be set to ILLEGAL REQUEST/ILLEGAL MODE FOR THIS THIS TRACK.	Mandatory
110b-111b	Reserved	—	—

6.24.2.3 DAP

Digital Audio Play (DAP) is used to control error concealment when the data being read is CD-DA. If the data being read is not CD-DA, DAP shall be ignored. If the data being read is CD-DA and DAP is set to zero, then the user data returned to the Initiator should not be modified by flaw obscuring mechanisms such as audio data mute and interpolate. If the data being read is CD-DA and DAP is set to one, then the user data returned to the Initiator should be modified by flaw obscuring mechanisms such as audio data mute and interpolate.

6.24.2.4 RelAdr

The RelAdr bit is not used by MM dLogical Units and shall be set to zero.

6.24.2.5 Starting Logical Block Address

The Starting Logical Block Address field specifies the logical block that the read operation shall begin.

6.24.2.6 Transfer Length

The Transfer Length field specifies the number of contiguous logical blocks of data that shall be transferred. A Transfer Length field of zero indicates that no transfer of data shall occur. This condition shall not be considered an error.

6.24.2.7 Main Channel Selection Bits

The Main Channel Field Selection Bits identify fields of the 2 352 bytes of main channel that the Initiator is requesting for each sector:

When Sync is zero, the sync field of data sectors shall not be included in the read data stream. If Sync is one, the 12-byte sync field (Figure 11) of data sectors shall be included in the read data stream.

The Header Codes refer to the sector header and the sub-header that is present in mode 2 formed sectors:

- 00b No header information shall be transferred.
- 01b The 4-byte sector header (Table 14) of data sectors shall be transferred,
- 10b The 8-byte sector sub-header (Table 19) of mode 2 formed sectors shall be transferred.
- 11b Both sector header and sub-header (12 bytes) shall be transferred. Header shall be transferred first.

When User Data is zero, the User Data field shall not be included in the read data stream. If User Data is one, the User Data field shall be included in the read data stream. The size of the user data field varies according to sector type.

When EDC & ECC is zero, no field that follows the user data field shall be included in the read data stream. If EDC & ECC is one, all fields that follow the user data field shall be included in the read data stream. The size of the EDC/ECC field varies according to sector type.

A few problems arise:

- The main channel fields selected may not actually be present in a given CD sector.
- It is not practical to provide data from 2 or more non-contiguous fields.

In these cases, the combination may be either considered invalid or mapped to a valid combination according to the following rules:

1. If no field is requested, then regardless of sector type, no data shall be transferred. This shall not be considered an error.
2. If the sector is CD-DA and any non-zero number of fields is requested, then the entire 2 352 bytes of main channel shall be transferred.
3. If the sector is a CD data type and the Initiator has selected fields that are non-contiguous for that sector type, the command shall be terminated with CHECK CONDITION status and sense bytes SK/ASC/ASCQ shall be set to ILLEGAL REQUEST/INVALID FIELD in CDB.

Table 351 shows a complete mapping of Main Channel Selection bits.

Table 351 – Main Channel Selection and Mapped Values

Main Channel Selection	Main Channel Selection Value ¹	Requirement ²	CD-DA	Mode 1	Mode 2 Formless	Mode 2 Form 1	Mode 2 Form 2
If the Initiator selects these fields		—	The Logical Unit shall map the selection to this value.				
No fields	00h	M	00h	00h	00h	00h	00h
EDC/ECC Only	08h	O	10h	08h	10h	08h	08h
User Data	10h	M	10h	10h	10h	10h	10h
User Data + EDC/ECC	18h	O	10h	18h	10h	18h	18h
Header	20h	O	10h	20h	20h	20h	20h
Header Only + EDC/ECC	28h	O	10h	Invalid	Invalid	Invalid	Invalid
Header & User Data	30h	O	10h	30h	30h	Invalid	Invalid
Header & User Data + EDC/ECC	38h	O	10h	38h	30h	Invalid	Invalid
Sub-Header Only	40h	O	10h	00h	00h	40h	40h
Sub-Header Only + EDC/ECC	48h	O	10h	Invalid	Invalid	Invalid	Invalid
Sub-Header & user data	50h	O	10h	10h	10h	50h	50h
Sub-Header & user data + EDC/ECC	58h	O	10h	18h	10h	58h	58h
All Headers Only	60h	O	10h	20h	20h	60h	60h
All Headers Only + EDC/ECC	68h	O	10h	Invalid	Invalid	Invalid	Invalid
All Headers & user data	70h	O	10h	30h	30h	70h	70h
All Headers & user data + EDC/ECC	78h	O	10h	38h	38h	78h	78h
Sync Only	80h	O	10h	80h	80h	80h	80h
Sync + EDC/ECC	88h	O	10h	Invalid	Invalid	Invalid	Invalid
Sync & User Data	90h	O	10h	Invalid	Invalid	Invalid	Invalid
Sync & User Data + EDC/ECC	98h	O	10h	Invalid	Invalid	Invalid	Invalid
Sync & Header Only	A0h	O	10h	A0h	A0h	A0h	A0h
Sync & Header Only + EDC/ECC	A8h	O	10h	Invalid	Invalid	Invalid	Invalid
Sync & Header + User Data	B0h	O	10h	B0h	B0h	Invalid	Invalid
Sync & Header + User Data + EDC/ECC	B8h	O	10h	B8h	B0h	Invalid	Invalid
Sync & Sub Header Only	C0h	O	10h	Invalid	Invalid	Invalid	Invalid
Sync & Sub Header Only + EDC/ECC	C8h	O	10h	Invalid	Invalid	Invalid	Invalid
Sync & Sub Header & User Data	D0h	O	10h	Invalid	Invalid	Invalid	Invalid
Sync & Sub Header & User Data + EDC/ECC	D8h	O	10h	Invalid	Invalid	Invalid	Invalid
Sync & All Headers Only	E0h	O	10h	A0h	A0h	E0h	E0h
Sync & All Headers Only + EDC/ECC	E8h	O	10h	Invalid	Invalid	Invalid	Invalid
Sync & All Headers & user data	F0h	O	10h	B0h	B0h	F0h	F0h
Sync & All Headers & user data + EDC/ECC	F8h	M	10h	B8h	B0h	F8h	F8h

¹This is CDB Byte 9 logically ANDed with F8h.
²M = Mandatory, O = Optional

6.24.2.8 C2 Error Information

The C2 Errors code (Table 352) provides for the inclusion of fabricated information based upon the results of C2 error correction (on main channel).

Table 352 – C2 Errors Codes

C2 Errors Code	Number of Bytes	Description
00b	0	No error information is returned.
01b	294	A bit is associated with each of the 2 352 bytes of main channel where: 0 = No C2 error and 1 = C2 error. This results in 294 bytes of C2 error bits. Return the 294 bytes of C2 error bits in the data stream.
10b	296	The Block Error Byte = Logical OR of all of the 294 bytes of C2 error bits. First return Block Error Byte, then a pad byte of zero and finally the 294 bytes of C2 error bits.
11b	—	Reserved

6.24.2.9 Sub-channel Selection bits

The Sub-channel Selection bits (Table 353) allow the Initiator to request that certain sub-channel information be included in the data stream.

Table 353 – Sub-Channel Selection Field Values

Sub-Channel Selection Bits	Meaning of Initiator Request	Field Size in Bytes
000b	No Sub-channel data shall be returned.	0
001b	RAW P-W Sub-channel data shall be returned.	96
010b	Formatted Q sub-channel data shall be transferred (See Table 354).	16
011b	Reserved	—
100b	Corrected and de-interleaved R-W sub-channel data shall be transferred.	96
101b	Reserved	—
110b	Reserved	—
111b	Reserved	—

The Initiator may select multiple fields in CDB bytes 9 and 10. The Logical Unit shall transfer the selected fields in the following order:

- | | |
|---------------|-------------------------|
| 1. Sync | 6. Mode 1 pad |
| 2. Header | 7. ECC parity |
| 3. Sub-header | 8. C2 block error bytes |
| 4. User Data | 9. C2 Error flags |
| 5. EDC | 10. Sub-channel |

6.24.3 Command Execution

6.24.3.1 Main Channel Field Formats

6.24.3.1.1 Sync Field

Synchronization for CD-DA sectors is performed by scanning sub-channel, so there is no sync pattern in the main channel of CD-DA.

Synchronization for CD data sectors is performed by scanning for the sync pattern in the main channel. This 12-byte pattern is identical for all types of data sectors. See Figure 11 in the models clause.

6.24.3.1.2 Headers

The specific sector address identification is based upon its synchronization method. A CD-DA sector address is identified by the Q sub-channel that follows its sub-channel synchronization pattern. So, a CD-DA sector does not contain a header in main channel.

Data sectors are synchronized in main channel, so the address identification is also in main channel: the header. The 4-byte header has the same format for all data sector types. See Table 14 in the models clause.

Only Mode 2 formed data types have a sub-header. The sub-header is 4 bytes in length, but is repeated so that it appears as the 8 bytes that immediately follows the sector header. See Table 19 in the models clause.

6.24.3.1.3 User Data

The user data is defined according to Sector Type field of the CDB:

For CD-DA, User Data is all 2 352 bytes of main channel.

For data Mode 1, User Data is 2 048 bytes beginning at offset 16 of the 2 352 bytes of main channel (see Table 16 in the models clause.).

For data Mode 2 formless, User Data is 2 336 bytes beginning at offset 16 of the 2 352 bytes of main channel (see Table 17 in the models clause.).

For data Mode 2, form 1, User Data is 2 048 bytes beginning at offset 24 of the 2 352 bytes of main channel (see Table 18 in the models clause.).

For data Mode 2, form 2, User Data is 2 324 bytes beginning at offset 24 of the 2 352 bytes of main channel (see Table 20 in the models clause.).

6.24.3.1.4 EDC and ECC

The presence and size of EDC redundancy or ECC parity within the 2 352 bytes of main channel is defined according to sector type:

CD-DA sectors have neither EDC redundancy nor ECC parity.

Data Mode 1 sectors have 288 bytes of EDC redundancy, Pad, and ECC parity beginning at offset 2 064 of the 2 352 bytes of main channel (see Table 16 in the models clause.).

Data Mode 2 formless sectors have neither EDC redundancy nor ECC parity (see Table 17 in the models clause.).

Data Mode 2 form 1 sectors have 280 bytes of EDC redundancy and ECC parity beginning at offset 2 072 of the 2 352 bytes of main channel (see Table 18 in the models clause.).

Data Mode 2 form 2 sectors optionally have 4 bytes of EDC redundancy beginning at offset 2 348 of the 2 352 bytes of main channel (see Table 20 in the models clause.).

6.24.3.1.5 C2 Errors

A bit is associated with each of the 2 352 bytes of main channel where: 0 = No C2 error and 1 = C2 error. The resulting bit field is ordered exactly as the main channel bytes. Each 8-bit boundary defines a byte of flag bits.

6.24.3.2 Sub-Channel Field Formats

6.24.3.2.1 Overview

Sub-channel data may be collected into 96 bytes of P-W sub-channel as it is separated from main channel during the read process. P and Q sub-channel is typically copied elsewhere for independent construction of 12 bytes each of P and Q sub-channel. See 4.2.2.2.

6.24.3.2.2 RAW P-W Sub-channel

Raw P-W sub-channel is the 96 bytes of sub-channel returned in the order received from the disc surface.

6.24.3.2.3 P and Q Sub-Channel

P sub-channel is recorded with the same bit value in each sub-channel byte. Due to potential media flaws and the lack of error correction, the most accurate method of determining P is by a redundancy vote.

Q sub-channel has a wide variety of formats (see 4.2.4.4 through 4.2.4.7), however all formats are based on one basic format of 10 bytes of data with 2 bytes of CRC. Both P and Q sub-channel are accessible via the READ CD command in a format shown in Table 354.

Table 354 – Formatted Q- Subchannel Data

Byte	Description
0	Control (4 MS bits), ADR (4 LS bits)
1	Track number
2	Index number
3	Min
4	Sec
5	Frame
6	ZERO
7	AMIN
8	ASEC
9	AFRAME
10	CRC or 00h (CRC is optional)
11	CRC or 00h (CRC is optional)
12	00h (pad)
13	00h (pad)
14	00h (pad)
15	Bits 6-0 shall be set to zero, Bit 7 may (optionally) contain the P Sub-channel value. If P sub-channel reporting is not supported, then bit 7 shall be set to zero.

6.24.3.2.4 Corrected and De-interleaved R-W Sub-channel

R-W sub-subchannel may contain graphical information (CD+G) or music controls (CD+MIDI). These forms may occur only on CD audio tracks.

The data from each sector is separated into 24-byte “packs” for de-interleaving. The interleaving is 8/24, so 3 contiguous sectors are needed to deinterleave the first pack. Consequently, in order to deliver the correct number of sector sets of R-W sub-channel, the Logical Unit shall include an additional 2 sectors internally.

Once deinterleave has been performed, each pack has Reed-Solomon correction applied and resulting data are sent to the Initiator in groups of 3 packs – 96 bytes.

For information on deinterleaving and error correction of R-W sub-channel, see System Description Compact Disc Digital Audio Addendum: R-W Sub-channels.

6.24.3.2.5 CD-Text

CD-Text may appear in CD audio tracks and the lead-in of a CD audio disc. CD-Text is packed, but the processing of the data is slightly different.

When the Starting Logical Block Address is set to F000 0000h and P-W raw data is selected, the Logical Unit returns P-W raw data from the Lead-in area. If there is no data recorded in the Lead-in area, the command shall be terminated with CHECK CONDITION status and set the values of SK/ASC/ASCQ to ILLEGAL REQUEST/ILLEGAL MODE FOR THIS TRACK or ILLEGAL REQUEST/INCOMPATIBLE MEDIUM INSTALLED.

If the Starting Logical Block Address is set to FFFF FFFFh after the above command, the Sub-channel data shall be returned from the current location within the Lead-in area. It is the responsibility

of the Initiator to convert this data to CD-TEXT format without losing streaming.

For information on deinterleaving and error correction of R-W sub-channel, see System Description Compact Disc Digital Audio Addendum: CD-TEXT.

6.24.4 Timeouts

The READ CD command belongs to timeout group 1. If the command is terminated with CHECK CONDITION status due to a timeout, sense bytes SK/ASC/ASCQ shall be set to UNIT ATTENTION/INSUFFICIENT TIME FOR OPERATION.

6.24.5 Error Reporting

Recommended error reporting for the READ CD command is defined in Table 355.

Table 355 – Recommended errors for READ CD Command

Error	Reference
Unit Attention conditions	Table F.1
CDB or parameter list validation errors	Table F.2
Readiness errors	Table F.3
General media access errors	Table F.5
Read errors	Table F.6
Hardware failures	Table F.8

6.25 READ CD MSF Command

6.25.1 Introduction

The READ CD MSF command provides a method for accessing most fields within any CD sector. This command is valuable for reading CD digital audio.

Table 356 shows the Features associated with the READ CD MSF command.

Table 356 – Features Associated with the READ CD MSF Command

Feature Number	Feature Name	Command Requirement
001Eh	CD Read	Mandatory
0028h	MRW	Recommended for CD-MRW
NOTE 1: The command requirement is valid only when the feature is current.		

6.25.2 The CDB and Its Parameters

6.25.2.1 The CDB

The READ CD MSF CDB is shown in Table 357.

Table 357 – READ CD MSF CDB

Bit	7	6	5	4	3	2	1	0	
Byte									
0	OPERATION CODE (B9h)								
1	Reserved			Expected Sector Type		DAP		Reserved	
2	Reserved								
3	Starting M Field								
4	Starting S Field								
5	Starting F Field								
6	Ending M Field								
7	Ending S Field								
8	Ending F Field								
9	Main Channel Selection Bits					C2 Errors		Reserved	
	SYNC	Header Codes		User Data	EDC & ECC				
10	Reserved					Sub-channel Selection Bits			
11	Control								

6.25.2.2 Expected Sector Type

See 6.24.2.2 for the definition of the Expected Sector Type field.

6.25.2.3 DAP

See 6.24.2.3 for the definition of the DAP field.

6.25.2.4 Starting M, Starting S, and Starting F Fields

The Starting M field, the Starting S field, and the Starting F field specify the absolute MSF address where the Read operation shall begin. The Starting MSF shall not begin earlier than the start of the first lead-in on the disc.

6.25.2.5 Ending M, Ending S, and Ending F Fields

The Ending M field, the Ending S field, and the Ending F field specify the absolute MSF address where the Read operation shall end. The Ending MSF shall not end later than 1.5 minutes beyond the start address of the last lead-out of the disc.

All contiguous sectors between the starting and ending MSF addresses shall be read.

NOTE 19: Reading across some CD structural boundaries may result in data errors.

If the Starting MSF Address is not found, the command shall be terminated with CHECK CONDITION status and set the values of SK/ASC/ASCQ to ILLEGAL REQUEST/ INVALID FIELD IN CDB.

If the Starting MSF Address is equal to the Ending MSF Address, no read operation occurs. This shall not be considered an error.

If the Starting MSF Address is greater than the Ending MSF Address, the command shall be terminated with CHECK CONDITION status and set the values of SK/ASC/ASCQ to ILLEGAL REQUEST/ INVALID FIELD IN CDB.

6.25.2.6 Main Channel Selection bits

See 6.24.2.7 for the definition of the Main Channel Selection bits field.

6.25.2.7 C2 Error Information

See 6.24.2.8 for the definition of the C2 Error Information field.

6.25.2.8 Sub-channel Selection bits

See 6.24.2.9 for the definition of the Sub-channel Selection bits field.

6.25.3 Command Execution

This command operates identically to the READ CD command (6.24.3) with the exception of how the Initiator selects the address range.

6.25.4 Timeouts

The READ CD MSF command belongs to timeout group 1. If the command is terminated with CHECK CONDITION status due to a timeout, sense bytes SK/ASC/ASCQ shall be set to UNIT ATTENTION/INSUFFICIENT TIME FOR OPERATION.

6.25.5 Error Reporting

Recommended error reporting for the READ CD MSF command is defined in Table 358.

Table 358 – Recommended errors for READ CD MSF Command

Error	Reference
Unit Attention conditions	Table F.1
CDB or parameter list validation errors	Table F.2
Readiness errors	Table F.3
General media access errors	Table F.5
Read errors	Table F.6
Hardware failures	Table F.8

6.26 READ DISC INFORMATION Command

6.26.1 Introduction

The READ DISC INFORMATION command allows the Initiator to request information about the currently mounted MM disc. When this command is required by an implemented Feature, the command shall always function, even if that Feature's Current bit becomes zero.

Table 359 shows the Features associated with the READ DISC INFORMATION command.

Table 359 – Features Associated with the READ DISC INFORMATION Command

Feature Number	Feature Name	Command Requirement
001Dh	Multi-Read	Mandatory
0021h	Incremental Streaming Writable	Mandatory
0025h	Write Once	Mandatory
0027h	CD-RW CAV Write	Mandatory
0028h	MRW	Mandatory
002Ah	DVD+RW	Mandatory (when Write bit is set to one)
002Bh	DVD+R	Mandatory (when Write bit is set to one)
002Eh	CD Mastering	Mandatory

6.26.2 The CDB and Its Parameters

The READ DISC INFORMATION CDB is shown in Table 360.

Table 360 – READ DISC INFORMATION CDB

Bit	7	6	5	4	3	2	1	0	
Byte									
0	Operation Code (51h)								
1	Reserved								
2	Reserved								
3	Reserved								
4	Reserved								
5	Reserved								
6	Reserved								
7	(MSB)	Allocation Length							
8								(LSB)	
9	Control Byte								

The number of Disc Information bytes returned is limited by the Allocation Length parameter of the CDB. An Allocation Length of zero shall not be considered an error. If the Allocation Length is greater than the amount of available Disc Information Data, only the available data is transferred.

6.26.3 Command Execution

6.26.3.1 Overview

The Logical Unit shall gather information about the medium, format it as shown in Table 361, and transfer to the Initiator, limited by the Allocation Length.

Table 361 – Disc Information Block

Byte	7	6	5	4	3	2	1	0
0	(MSB) Disc Information Length (LSB)							
1								
2	Reserved		Erasable	State of last Session		Disc Status		
3	Number of First Track on Disc							
4	Number of Sessions (Least Significant Byte)							
5	First Track Number in Last Session (Least Significant Byte)							
6	Last Track Number in Last Session (Least Significant Byte)							
7	DID_V	DBC_V	URU	DAC_V	Reserved	Dbit	BG Format Status	
8	Disc Type							
9	Number of Sessions (Most Significant Byte)							
10	First Track Number in Last Session (Most Significant Byte)							
11	Last Track Number in Last Session (Most Significant Byte)							
12	(MSB) Disc Identification (LSB)							
13								
14								
15								
16	(MSB) Last Session Lead-in Start Address (LSB)							
17								
18								
19								
20	(MSB) Last Possible Lead-out Start Address (LSB)							
21								
22								
23								
24	(MSB) Disc Bar Code (LSB)							
...								
31								
32								
33	Number of OPC Tables							
34 – n	OPC Table Entries							

6.26.3.2 Disc Information Length

The Disc Information Length is the number of bytes Disc Information available. The Disc Information Length excludes itself. The value is $32 + 8 * (\text{Number of OPC Tables})$.

6.26.3.3 Erasable Bit

The Erasable bit, when set to one, indicates that CD-RW, DVD-RAM, DVD-RW or DVD+RW medium is present and the Logical Unit is capable of writing the media. If the Erasable bit is set to zero, then either the medium is not erasable or the Logical Unit is unable to write the media.

6.26.3.4 State of Last Session

The State of Last Session field (Table 362) specifies the recorded state of the last session, regardless of the number of sessions on the disc.

Table 362 – State of Last Session

Session State	Definition
00b	Empty Session
01b	Incomplete Session ¹
10b	Reserved / Damaged Session (Valid only for DVD-R/-RW media)
11b	Complete Session ² (valid only for Disc Status = 10b or 11b)
NOTES:	
1. When a disc is in DVD-RW restricted overwrite mode and the last session is in the Intermediate State, this status code is returned.	
2. Non-blank DVD+RW reports 11b.	

6.26.3.5 Disc Status

The Disc Status field (Table 363) indicates the recorded status of the disc. A Logical Unit that does not have the ability to write the inserted medium shall return only COMPLETE (10b) status.

Table 363 – Disc Status

Status	Definition	Description
00b	Empty Disc	A recordable disc is present and is either logically or physically blank.
01b	Incomplete Disc ¹	The currently mounted disc is recorded/recordable serially in sessions. The last session is either blank or partially recorded.
10b	Finalized Disc ²	The currently mounted disc is recorded/recordable serially in sessions. The last session is closed and there is no possibility of appending a new session.
11b	Others	The currently mounted disc supports only random access writing and is not recordable serially in multiple sessions.
¹ When a disc is in DVD-RW restricted overwrite mode and the last session is Intermediate state, this status code is returned.		
² Some ReWritable media may allow the last session to be grown via the FORMAT UNIT command.		

6.26.3.6 Number of First Track on Disc

The Number of First Track on Disc is the track number of the track that contains LBA 0. The value reported is based upon media type and recorded status:

- For CD-ROM and DDCD-ROM the value is the smallest track number recorded in the first TOC on the disc.
- For CD-R, CD-RW, DDCD-R, and DDCD-RW recorded as ROM (i.e., the PMA is blank, but the first TOC is written), the value is the smallest track number recorded in the first TOC on the disc.
- For CD-R, CD-RW, DDCD-R, and DDCD-RW, where the PMA is not blank, the value is the smallest track number recorded in the PMA.
- For CD-R, CD-RW, DDCD-R, and DDCD-RW, where the PMA is blank and the first TOC on the disc is also blank, the value is one (1).
- For all other media regardless of recording status, the value is one (1).

6.26.3.7 First Track Number in Last Session

First Track Number in Last Session (bytes 5 & 10) is the track number of the first track in the last session. This includes the incomplete track.

6.26.3.8 Last Track Number in Last Session

Last Track Number in Last Session (bytes 6 & 11) is the track number of the last track in the last session. This includes the incomplete track.

6.26.3.9 DID_V Bit

The DID_V (Disc ID Valid) bit, when set to one, indicates that the Disc Identification field is valid.

6.26.3.10 DBC_V Bit

The DBC_V (Disc Bar Code Valid bit, when set to one, indicates that the Disc Bar Code field (bytes 24 through 31) is valid.

6.26.3.11 URU Bit

The URU (Unrestricted Use Disc) bit may be zero for special use CD-R, CD-RW, DVD-R, or DVD-RW medium. For all other media types, URU shall be set to one. When URU is zero, the mounted disc is defined for restricted use. Recording to a restricted use disc, required the appropriate Initiator Application code set in the Write Parameters Page. When URU is set to one, the mounted medium has unrestricted write use.

6.26.3.12 DAC_V

DAC_V indicates the validity of the Disc Application Code in byte 32. If DAC_V is set to zero, then the Disc Application Code is not valid. If DAC_V is set to one, the Disc Application Code is valid.

6.26.3.13 Dbit

If the disc is MRW formatted or MRW formatting (state = 01b, 10b, or 11b), then bit 2 of byte 7 (Dbit) is a copy of the "dirty bit" from the defect table. If Dbit is set to zero, then the MRW structures are current. If Dbit is set to one, then the MRW structures may not be current. When BG format status = 00b, Dbit shall be set to zero.

6.26.3.14 BG Format Status

The BG format status is the background format status of the mounted disc (See Table 364). Logical Units that report the Formattable Feature and either the MRW Feature or the DVD+RW Feature, or both are required to implement Background format. For all other Logical Units, this field shall be 00b.

Table 364 – Background Format Status Codes

BG format status	Meaning
00b	At least one of the following is true: <ol style="list-style-type: none"> 1. The disc is neither CD-RW nor DVD+RW. 2. The disc is CD-RW, it is not formatted as CD-MRW. 3. If the disc is DVD+RW, it is blank.
01b	A background format was started but is not currently running and is not complete.
10b	A background format is in progress. A format has been started or restarted and is not yet completed.
11b	Background formatting has completed.

6.26.3.15 Disc Type

The Disc Type field is associated only with CD and DD CD media types. For all other media types, this field shall contain 00h. The Disc Type field specifies the type of data recorded on the disc. For DD CD, the Disc Type shall be set to 20h. For CD media, the Disc Type shall be obtained from the PMA or from the TOC of the first session. The discovery sequence is as follows:

1. Initialize Disc Type to FFh.
2. If a Disc ID item is written in the PMA, replace with the Disc Type field from that item.
3. If the disc is COMPLETE, replace with Session Format from the first Session. Otherwise, scan all complete sessions for a session that contains at least one data track. If found replace with the Session Format field.

Valid Disc Types are shown in Table 365.

Table 365 – Disc Type Field

Disc Type Code	Disc Type
00h	CD-DA or CD-ROM Disc
10h	CD-I Disc
20h	CD-ROM XA Disc or DDCD
FFh	Undefined
All Other Values	Reserved

6.26.3.16 Disc Identification Number

For CD and DDCD, the Disc Identification number recorded in the PMA is returned. The Disc Identification Number is recorded in the PMA as a six-digit BCD number. It is returned in the Disc Information Block as a 32 bit binary integer. This value should be zero filled for all other media types.

6.26.3.17 Last Session Lead-in Start Address

The Last Session Lead-in Start Address field is dependent on medium and recorded status:

- For CD-R, CD-RW, DDCD-R and DDCD-RW media the Last Session Lead-in Start Address is the HMSF format address of where the next Lead-in shall be recorded. If the disc has complete status, then the value returned shall be FFh, FFh, FFh, FFh.
- For DVD+R media the Last Session Lead-in Start Address is the LBA of where the next Intro shall be recorded. If the disc has complete status, then the value returned shall be FFFFFFFFh.
- For all other media types, this field shall be filled with zeros.

6.26.3.18 Last Possible Lead-out Start Address

The Last Possible Lead-out Start Address field is dependent on medium and recorded status:

- For CD-R, CD-RW, DDCD-R and DDCD-RW the Last Possible Lead-out Start Address is the HMSF format address found in the ATIP of the disc's lead-in. If the disc is Complete, the Last Possible Lead-out Start Address shall be FFh:FFh:FFh:FFh HMSF.
If the media is according to *High Capacity Recordable Disc Systems*, the address given shall be Start Time of Additional Capacity + Capacity Extension – expected Lead-out Size, where expected lead-out size is 90 seconds for single session discs and 30 seconds for discs with two or more sessions.
- For DVD+R media the Last Possible Lead-out Start Address is the LBA found in the ADIP of the disc's lead-in. If the disc is Complete, the Last Possible Lead-out Start Address shall be FFFFFFFFh.
- For all other media types, this field shall be filled with zeros.

6.26.3.19 Disc Bar Code

The Disc Bar Code field contains the hexadecimal value of the bar code if the Logical Unit has the ability to read Disc Bar Code and a bar code is present. For all other media this field should be set to zeros.

6.26.3.20 Disc Application Code

Disc Application Code shall be the value discovered on the disc. If the disc has no Disc Application Code, then the contents shall be set to zero.

6.26.3.21 OPC Table

An OPC (Optimum Power Calibration) Table is attached only if the values are known for the disc. Since OPC values are likely to be different for different recording speeds, each table entry is associated with a recording speed. For DVD-R/-RW, the use of OPC tables is vendor specific.

The format of an OPC Table is shown in Table 366. Speed is in □bytes per second. The OPC Value field is associated with the speed specified in the speed field, and its content is vendor specific.

Table 366 – OPC Table Entry

Byte	Bit	7	6	5	4	3	2	1	0
0	(MSB)	Speed							
1		(□bytes per second)							
2		OPC Values							
3									
4									
5									
6									
7									

6.26.4 Timeouts

The READ DISC INFORMATION command belongs to timeout group 1. If the command is terminated with CHECK CONDITION status due to a timeout, sense bytes SK/ASC/ASCQ shall be set to UNIT ATTENTION/INSUFFICIENT TIME FOR OPERATION.

6.26.5 Error Reporting

Recommended error reporting for the READ DISC INFORMATION command is defined in Table 367.

Table 367 – Recommended errors for READ DISC INFORMATION Command

Error	Reference
Unit Attention conditions	Table F.1
CDB or parameter list validation errors	Table F.2
Readiness errors	Table F.3
General media access errors	Table F.5
Read errors	Table F.6
Hardware failures	Table F.8

6.27 READ DVD STRUCTURE Command

6.27.1 Introduction

The READ DVD STRUCTURE command requests that the DVD Logical Unit transfer data from areas on the DVD Media to the Initiator.

Table 368 shows the Features associated with the READ DVD STRUCTURE command.

Table 368 – Features Associated with the READ DVD STRUCTURE Command

Feature Number	Feature Name	Command Requirement
0004h	Write Protect	Format codes C0h, FFh Mandatory
001Fh	DVD Read	Mandatory
0024h	Defect Management (SSA = 1)	Format code 0Ah Mandatory
0106h	DVD CSS	Format code 02h Mandatory
010Ah	DCB	Format code 30h Mandatory
10Bh	DVD CPRM	Mandatory

6.27.2 The CDB and Its Parameters

6.27.2.1 The CDB

The READ DVD STRUCTURE CDB is shown in Table 369.

Table 369 – READ DVD STRUCTURE CDB

Bit	7	6	5	4	3	2	1	0
0	Operation Code (ADh)							
1	Reserved							
2	(MSB) Address (LSB)							
3								
4								
5								
6	Layer Number							
7	Format							
8	(MSB) Allocation Length (LSB)							
9								
10	AGID		Reserved					
11	Control							

6.27.2.2 Address

The Address field definition is dependent upon the value in the Format field.

6.27.2.3 Layer Number

Use of the Layer Number field is dependent upon the Format field value. See Table 370.

6.27.2.4 Format

The Format field (Table 370) indicates the type of information that is requested by the Initiator.

6.27.2.5 Allocation Length

The Allocation Length field specifies the maximum number of bytes that may be returned by the Logical Unit. An Allocation Length field of zero shall not be considered an error.

6.27.2.6 AGID

The AGID field is described in the REPORT KEY command. This field is used only when the Format field contains 2h, 6h or 7h with Address field of 0000000h, for all other values it is reserved.

Requests for Format FFh shall always be fulfilled, even if there is no medium or an incompatible medium installed.

When a READ DVD STRUCTURE command is issued for non-DVD media, with format codes 00h – BFh, the command shall be terminated with CHECK CONDITION status and SK/ASC/ASCQ shall be set to ILLEGAL REQUEST/CANNOT READ MEDIUM/INCOMPATIBLE FORMAT. When the Logical Unit/media combination does not support the specified Format code, the command shall be terminated with CHECK CONDITION status and SK/ASC/ASCQ shall be set to ILLEGAL REQUEST/INVALID FIELD IN CDB.

Table 370 – Format Code Definitions

Format Code	Layer Field Usage	Address Field Usage	Description
00h	Layer	Reserved	Physical Information in the DVD Lead-in area. Multi-session DVD-R/-RW returns information in the last Border-in.
01h	Layer	Reserved	Copyright Information from the DVD Lead-in area
02h	Reserved	Reserved	Disc Key obfuscated by a Bus Key
03h	Reserved	Reserved	Burst Cutting Area information on DVD media
04h	Layer	Reserved	Disc Manufacturing Information from the DVD Lead-in area
05h	Reserved	LBA	Copyright Management information from specified sector
06h	Reserved	Reserved	Media Identifier protected by a Bus Key
07h	Reserved	Pack Number	Media Key Block protected by a Bus Key
08h	Reserved	Reserved	DDS information on DVD-RAM Media
09h	Reserved	Reserved	DVD-RAM Medium Status
0Ah	Reserved	Reserved	DVD-RAM Spare Area Information
0Bh	Reserved	LBA	DVD-RAM Recording Type Information is returned from the specified sector
0Ch	Reserved	Reserved	DVD-R/-RW RMD in last border-out
0Dh	Reserved	Start Field Number of RMA blocks	Specified RMD field from last recorded border out on DVD-R/-RW
0Eh	Reserved	Reserved	Pre-recorded information from DVD-R/-RW lead-in
0Fh	Reserved	Reserved	DVD-R/-RW Media Identifier
10h	Layer	Reserved	DVD-R/-RW Physical Format Information
11h	Reserved	Reserved	ADIP Information
12h – 2Fh	Reserved		
30h	Reserved/ Session number	Content Descriptor	Disc Control Block identified by content descriptor
31h	Reserved	PSN	Read MTA ECC Block from DVD+MRW disc
32h – BFh	Reserved		
C0h	Reserved	Reserved	Write Protection Status
C1h – Feh	Reserved		
FFh	Layer	Reserved	READ/SEND DVD STRUCTURE capability list

6.27.3 Command Execution

6.27.3.1 Format Code 00h: Physical Format Information

For DVD-R/-RW media, this Format code returns the last updated Physical format information. Therefore, e.g., if a medium is recorded with multi-bordered area, this information is retrieved from the last Border-in. If Control Data Zone information in the Lead-in is required for DVD-R/-RW media, use format code = 10h. For all other DVD class media, format code 00h returns information from the Control Data Zone in the lead-in.

Physical Format Information is shown in Table 371.

Table 371 – READ DVD STRUCTURE Data Format (Format field = 00h)

Byte	Bit	7	6	5	4	3	2	1	0
0	(MSB)	DVD STRUCTURE Data Length							
1		(LSB)							
2		Reserved							
3		Reserved							
DVD Lead-in Structure									
0 – 2047		Layer Descriptor							

The DVD STRUCTURE Data Length specifies the length in bytes of the following DVD STRUCTURE data that is available to be transferred to the Initiator. The DVD STRUCTURE Data Length value does not include the DVD STRUCTURE Data Length field itself.

Layer Descriptor is defined in Table 372.

Table 372 – Layer Descriptor

Byte	Bit	7	6	5	4	3	2	1	0
0		Book Type				Part Version			
1		Disc Size				Maximum Rate			
2		Reserved	Number of Layers		Track Path	Layer Type			
3		Linear Density				Track Density			
4		00h							
5	(MSB)	Starting Physical Sector Number of Data Area							
6									
7									
8		00h							
9	(MSB)	End Physical Sector Number of Data Area							
10									
11									
12		00h							
13	(MSB)	End Physical Sector Number in Layer 0							
14									
15									
16		BCA	Reserved						
17 – 2047		Media Specific							

This information is returned for DVD media only. The information for the layer specified by the Layer Number field in the Command Packet is returned. If there is only one layer then the only valid layer is

layer 0. If a nonexistent layer is requested then the command shall be aborted with an INVALID FIELD IN CDB error. If the media has more than one layer, but is recorded using the Opposite Track Path method, then the same information shall be returned for all layers.

The Book Type field (Table 373) specifies the DVD Book this media complies with.

Table 373 – Book Type Field

Book Type	Book Name
0000b	DVD-ROM
0001b	DVD-RAM
0010b	DVD-R
0011b	DVD-RW
1001b	DVD+RW
1010b	DVD+R
Others	Reserved

The Part Version specifies the version of the specified book that this media complies with.

The Disc Size specifies the physical size of the Media. A value of 0000b specifies 120mm, a value of 0001b specifies a size of 80mm.

The Maximum Rate field (Table 374) is used to specify to the Logical Unit the read rate to use for this media.

Table 374 – Maximum Rate Field

Maximum Rate	Read Rate
0000b	2.52 Mbps
0001b	5.04 Mbps
0010b	10.08 Mbps
1111b	Not Specified
Others	Reserved

The Number of Layers field specifies the number of layers for this side of the media. A value of 00b indicates that the media has only one layer. A value of 01b specifies that this side of the media has two layers. Currently only one and two layer discs are specified.

The Track Path bit specifies the direction of the layers when more than one layer is used. If the bit is set to 0 then this media uses Parallel Track Path (PTP). When PTP is used each layer is independent and has its own Lead-in and Lead-out areas on the media. If the bit is set to 1 then the media uses Opposite Track Path (OTP). With opposite track path both layers are tied together. There is only one Lead-in and Lead-out. In the middle of the media there is an area called the middle area. The addresses of blocks in one layer are mirrored in the other layer.

The Layer Type field (Table 375) indicates the read/write ability of the layer.

Table 375 – Layer Type Field

Bit	Layer Type
0	Layer contains embossed data
1	Layer contains recordable area
2	Layer contains rewritable area
3	Reserved

The Linear Density field (Table 376) indicates the minimum/maximum pit length used for this layer.

Table 376 – Linear Density Field

Linear Density Code	Linear Density
0000b	0.267 $\mu\text{m}/\text{bit}$
0001b	0.293 $\mu\text{m}/\text{bit}$
0010b	0.409 to 0.435 $\mu\text{m}/\text{bit}$
0100b	0.280 to 0.291 $\mu\text{m}/\text{bit}$
1000b	0.353 $\mu\text{m}/\text{bit}$
Others	Reserved

The Track Density field (Table 377) indicates the track width used for this media. Currently = 0000b
0.74 $\mu\text{m}/\text{track}$

Table 377 – Track Density Field

Track Density Code	Track Density
0000b	0.74 $\mu\text{m}/\text{track}$
0001b	0.80 $\mu\text{m}/\text{track}$
0010b	0.615 $\mu\text{m}/\text{track}$
Others	Reserved

The Starting Sector Number of Data Area field (Table 378) specifies the first block that contains user data.

Table 378 – Starting Physical Sector Number of Data Area field

Starting Sector Number	Media Type
30000h	DVD-ROM, DVD-R/-RW, DVD+RW
31000h	DVD-RAM
Others	Reserved

The End Physical Sector Number of Data Area field specifies the last sector of the user data in the last layer of the media. For DVD-RAM, the End Physical Sector Number of Data Area is the PSN for the last spare sector of the last zone.

The End Sector Number in Layer 0 field specifies the last sector of the user data in layer 0. If this media does not use Opposite Track Path and contains Multiple Layers, this value is set to 000000h.

The Burst Cutting Area (BCA) flag indicates the presence of data in the Burst Cutting Area. If set to zero, it indicates BCA data does not exist. If set to one, it indicates BCA data exist.

In case of DVD-R/-RW, the Logical Unit may have cache memory for the Lead-in Control data. If the disc has no Lead-in, and there is no DVD Control Data in the cache, the Logical Unit shall generate CHECK CONDITION status and set SK/ASC/ASCQ values to ILLEGAL REQUEST/INVALID FIELD IN CDB. If the Lead-in is already written or there are DVD structures in the cache, the Logical Unit shall return the requested structures.

The Media Specific field may be filled with all zero data or information as specified in the associated DVD specification.

Most of the data in the layer descriptor for DVD+RW media is from the ADIP information block (see *DVD+RW 4,7 Gbytes Basic Format Specifications*). The DVD+RW layer descriptor is shown in Table 379.

Table 379 – DVD+RW Layer Descriptor

Byte	Bit	7	6	5	4	3	2	1	0
0 – 8		Copy of bytes 0 through 8 from ADIP information block							
9		If CDZ PSN \leq 2F0FFh, then this value shall be the PSN of last recorded sector in DZ. Otherwise, this value may be either the PSN of last recorded sector in DZ, or the last possible PSN in the DZ.							
10									
11									
12 – 18		00h							
19 – 255		Copy of bytes 19 – 255 from ADIP information block							
256 – 2047		Reserved							

6.27.3.2 Format Code 01h: DVD Copyright Information

The Read DVD Structure data format 01h (Table 380) includes the DVD Copyright information response.

Table 380 – READ DVD STRUCTURE Data Format (Format field = 01h)

Byte	Bit	7	6	5	4	3	2	1	0
0	(MSB)	DVD STRUCTURE Data Length							
1		(LSB)							
2		Reserved							
3		Reserved							
DVD Copyright Information									
0		Copyright Protection System Type							
1		Region Management Information							
2		Reserved							
3		Reserved							

The DVD STRUCTURE Data Length specifies the length in bytes of the following DVD STRUCTURE data that is available to be transferred to the Initiator. The DVD STRUCTURE Data Length value does not include the DVD STRUCTURE Data Length field itself.

The Copyright Protection System Type field indicates the presence of data structures specific to a copyright protection system. Three values are defined, 00h indicates there is no such data and 01h indicates a specific data structure for CSS/CPPM exists, and 02h indicates a specific data structure for CPRM exists. All other values are reserved.

The Region Management Information field describes the regions in that the disc may be played. Each bit represents one of eight regions. If a bit is not set in this field, the disc may be played in the corresponding region. If a bit is set in this field the disc may not be played in the corresponding region.

6.27.3.3 Format Code 02h: Disc Key

The Disc Key data recorded on the media is identified with a data format defined in Table 381.

Table 381 – READ DVD STRUCTURE Data Format (Format field = 02h)

Bit	7	6	5	4	3	2	1	0
Byte								
0	(MSB) DVD STRUCTURE Data Length							(LSB)
1								
2	Reserved							
3	Reserved							
Disc Key Structures								
0	DISC KEY Data							
...								
2047								

The DVD STRUCTURE Data Length specifies the length in bytes of the following DVD STRUCTURE data that is available to be transferred to the Initiator. The DVD STRUCTURE Data Length value does not include the DVD STRUCTURE Data Length field itself.

DISC KEY Data field returns the DISC KEY data for CSS and/or the Album Identifier for CPPM that are obfuscated by a Bus Key. The length of DISC KEY Data field is currently 2 048 bytes.

When neither the DISC KEY data nor the Album Identifier exist on DVD media, this command with Format = 02h shall be terminated with CHECK CONDITION status and SK/ASC/ASCQ values shall be set to ILLEGAL REQUEST/COPY PROTECTION KEY EXCHANGE FAILURE – KEY NOT PRESENT.

When the DVD Logical Unit is not in the Bus Key Established state for CSS/CPPM, this command with Format = 02h shall be terminated with CHECK CONDITION status and SK/ASC/ASCQ values shall be set to ILLEGAL REQUEST/COPY PROTECTION KEY EXCHANGE FAILURE – KEY NOT ESTABLISHED.

6.27.3.4 Format Code 03h: BCA Information

The BCA information is defined in data format 03h shown in Table 382.

Table 382 – READ DVD STRUCTURE Data Format (Format field =03h)

Bit	7	6	5	4	3	2	1	0
Byte								
0	(MSB) DVD STRUCTURE Data Length (LSB)							
1								
2	Reserved							
3	Reserved							
DVD BCA Structure								
0	BCA Information							
...								
...								
...								
n								

The DVD STRUCTURE Data Length specifies the length in bytes of the following DVD STRUCTURE data that is available to be transferred to the Initiator. The DVD STRUCTURE Data Length value does not include the DVD STRUCTURE Data Length field itself.

The BCA Information is returned from BCA recorded DVD media only. The Length of BCA Information is in the range of 12 to 188 bytes.

When a READ DVD STRUCTURE command with a Format field value of 03h is presented for a DVD media without BCA, the command shall be terminated with CHECK CONDITION status and SK/ASC/ASCQ values shall be set to ILLEGAL REQUEST/INVALID FIELD IN CDB.

6.27.3.5 Format Code 04h: DVD Disc Manufacturing Information

Table 383 defines the data format for the Disc Manufacturing information.

Table 383 – READ DVD STRUCTURE Data Format (Format field = 04h)

Byte	Bit	7	6	5	4	3	2	1	0
0	(MSB)	DVD STRUCTURE Data Length							
1									
2	Reserved								
3	Reserved								
DVD Manufacturing's Structures									
0	Disc Manufacturing Information								
...									
...									
...									
2047									

The DVD STRUCTURE Data Length specifies the length in bytes of the following DVD STRUCTURE data that is available to be transferred to the Initiator. The DVD STRUCTURE Data Length value does not include the DVD STRUCTURE Data Length field itself.

The Disc Manufacturing Information is taken from the DVD media Lead-in. In the case of DVD-R/-RW multi session disc, this information is taken from the last Border-in.

6.27.3.6 Format Code 05h: Copyright Management Information

The Copyright Management Information returned is shown in Table 384.

Table 384 – READ DVD STRUCTURE Data Format (Format field = 05h)

Bit	7	6	5	4	3	2	1	0
Byte								
0	(MSB) DVD STRUCTURE Data Length							(LSB)
1								
2	Reserved							
3	Reserved							
Copyright Management Information								
0	CPR_MAI							
1	Reserved							
2	Reserved							
3	Reserved							

The DVD STRUCTURE Data Length specifies the length in bytes of the following DVD STRUCTURE data that is available to be transferred to the Initiator. The DVD STRUCTURE Data Length value does not include the DVD STRUCTURE Data Length field itself.

The definition of the CPR_MAI field depends on the mounted media. The CPR_MAI field definition is shown in Table 305.

Table 385 – CPR_MAI Field Definition

Media	Bit	7	6	5	4	3	2	1	0
DVD-ROM		CPM	CP_SEC	CGMS		CP_MOD			
DVD-R, ver 1.0 DVD-RW, ver 1.0		CPM	Resvd	CGMS		Reserved			
DVD-RAM Ver.1.0/2.1 DVD-R for Authoring Ver .2.0		Reserved							
DVD-R for General, ver 2.0, DVD-RW, ver 1.1, and DVD+RW		Reserved			ADP_TY		Reserved		

The CPM bit, if set to 0, indicates that this sector contains no copyrighted material. If the CPM bit is set to 1, this sector contains copyrighted material.

When the CPM bit is set to 0, the CP_SEC bit is set to zero. When the CPM bit is set to 1, the CP_SEC bit indicates whether this sector has a specific data structure for prerecorded media copyright protection system. A value of 0 indicates that no such data structure exists in this sector. A value of 1 indicates a specific data structure for CSS or CPPM exists in this sector.

When the CPM bit is set to 0, the CGMS field is set to 00b. When the CPM bit is set to 1, and if the CGMS field is set to 00b, it indicates that copying is permitted without restriction. If the CGMS field is

set to 01b, it indicates that the CGMS field is reserved, and if the CGMS field is set to 10b, indicates that one generation of copies may be made, and if the CGMS field is set to 11b, indicates that no copying is permitted.

When the CP_SEC bit is set to 0, the CP_MOD field is set to 0h. When the CP_SEC bit is set to 1, the CP_MOD field indicates the copyright protection mode of the specified sector. A value of 0h indicates the sector is scrambled by CSS. A value of 1h indicates the sector is encrypted by CPPM. Other values are reserved.

The ADP_TY field is defined only for DVD-RW Ver.1.1 and DVD-R for General Ver.2.0 media. The ADP_TY field, if set to 01b, indicates that this sector contains materials defined in DVD Specifications for Read-Only Disc Part 3 VIDEO SPECIFICATIONS. A value of 00b indicates that no such data exists in this sector. All other values of ADP_TY are reserved.

NOTE 20: For DVD-R/-RW media, a value of each field may not be correct at the first and last 16 sectors of each recording extent due to the nature of recording method for DVD-R/-RW media.

If the currently mounted medium is DVD+RW with basic formatting operating in background, or DVD+RW with MRW formatting operating in background, is command operation shall be as follows:

- a) If any of the sectors within the range specified by the CDB are in a blank area of the media where format writing has not yet occurred, the blank sectors shall not be read and the command shall fabricate and return data as if the sectors had been format written.
- b) If all of the sectors within the range specified by the CDB are in an area of the media where format writing has occurred, the command shall operate normally.

6.27.3.7 Format Code 06h: Media Identifier

The Media Identifier data recorded on the media is identified with a data format defined in Table 386.

Table 386 – READ DVD STRUCTURE Data Format (Format Field = 06h)

Byte	Bit	7	6	5	4	3	2	1	0
0	(MSB)	DVD STRUCTURE Data Length							(LSB)
1									
2		Reserved							
3		Reserved							
Media Identifier Structures									
0	(MSB)	Media Identifier Data							(LSB)
:									
n									

The DVD STRUCTURE Data Length specifies the length in bytes of the following DVD STRUCTURE data that is available to be transferred to the Initiator. The DVD STRUCTURE Data Length value does not include the DVD STRUCTURE Data Length field itself.

The Media Identifier Data field returns the Media Identifier that is protected by a Bus Key.

When the DVD Logical Unit is not in the Bus Key Established state for CPRM, this command with Format = 06h shall be terminated with CHECK CONDITION status and SK/ASC/ASCQ values shall be set to ILLEGAL REQUEST/COPY PROTECTION KEY EXCHANGE FAILURE – KEY NOT ESTABLISHED.

6.27.3.8 Format Code 07h: Media Key Block

The Media Key Block pack data recorded on the media is identified with a data format defined in Table 387.

Table 387 – READ DVD STRUCTURE Data Format (Format Field = 07h)

Byte	Bit	7	6	5	4	3	2	1	0
0	(MSB)	DVD STRUCTURE Data Length							(LSB)
1									
2		Reserved							
3		Total Packs							
Media Key Block Structures									
0	(MSB)	Media Key Block Pack Data							(LSB)
:									
n									

The DVD STRUCTURE Data Length specifies the length in bytes of the following DVD STRUCTURE data that is available to be transferred to the Initiator. The DVD STRUCTURE Data Length value does not include the DVD STRUCTURE Data Length field itself.

The Total Packs field reports the total number of Media Key Block Packs that are available for transfer to the Initiator.

The Media Key Block Pack Data field returns the requested Media Key Block Pack that is protected by a Bus Key only when the Address field set to 00000000h.

The Address field in the command specifies the available Media Key Block Packs that shall be read. A valid AGID field value shall be supplied only when the Address field is set to 00000000h.

If the Address field value is 00000000h, the DVD Logical Unit is not in the Bus Key Established state for CPRM, and Format = 07h, this command shall be terminated with CHECK CONDITION status and SK/ASC/ASCQ values shall be set to ILLEGAL REQUEST/COPY PROTECTION KEY EXCHANGE FAILURE – KEY NOT ESTABLISHED.

6.27.3.9 Format Code 08h: DVD-RAM Disc Definition Structure (DDS)

The DVD-RAM Disc definition is identified with the data format defined in Table 388.

Table 388 – READ DVD STRUCTURE Data Format (Format field = 08h)

Byte	Bit	7	6	5	4	3	2	1	0
0	(MSB)	DVD STRUCTURE Data Length							
1		(LSB)							
2		Reserved							
3		Reserved							
DVD-RAM Disc Definition Structure (DDS)									
0		DDS Information							
...									
2047									

The DVD STRUCTURE Data Length specifies the length in bytes of the following DVD STRUCTURE data that is available to be transferred to the Initiator. The DVD STRUCTURE Data Length value does not include the DVD STRUCTURE Data Length field itself.

The DDS Information is taken from the Defect Controls of the DVD-RAM media lead-in. The length of the DDS Information is currently 2 048 bytes only.

When a READ DVD STRUCTURE command with a format field value of 08h is presented for other than DVD-RAM media, the command shall be terminated with CHECK CONDITION status and SK/ASC/ASCQ values shall be set to ILLEGAL REQUEST/INVALID FIELD IN CDB.

6.27.3.10 Format Code 09h: DVD-RAM Medium Status

The DVD-RAM Medium Status data returned is defined in Table 389.

Table 389 – READ DVD STRUCTURE Data Format (Format = 09h)

Bit	7	6	5	4	3	2	1	0
Byte								
0	(MSB) DVD STRUCTURE Data Length (LSB)							
1								
2	Reserved							
3	Reserved							
DVD-RAM Medium Status Data								
0	Cartridge	OUT	Reserved	MSWI	CWP	PWP	Reserved	
1	Disc Type Identification							
2	Reserved							
3	RAM – SWI Information							

When a READ DVD STRUCTURE command with the Format field value of 09h is issued for other than DVD-RAM media, this command shall be terminated with CHECK CONDITION status and SK/ASC/ASCQ values shall be set to ILLEGAL REQUEST/INVALID FIELD IN CDB.

The DVD STRUCTURE Data Length indicates the length in bytes of the following DVD Structure data that is available to be transferred to the Initiator. The DVD Structure Data Length value does not include the DVD STRUCTURE Data Length field itself.

The Cartridge bit of one indicates that a medium is in a cartridge. The Cartridge bit of zero indicates that a medium is not in a cartridge.

The Out bit of one indicates that a medium has been taken out from a cartridge or a medium is put into a cartridge. The Out bit of zero indicates that a medium has not been taken out from a cartridge. This field is valid only when the Cartridge bit is set to one. If the Cartridge bit is set to zero, the Out bit shall be set to zero.

The Media Specific Write Inhibition (MSWI) bit of one indicates that the writing is inhibited by the specific reason. The reason is indicated in the RAM-SWI Information field. The MSWI bit of zero indicates that the writing is not inhibited by the specific reason.

The Persistent Write Protection (PWP) bit of one indicates that the media surface is set to write protected status. The PWP bit of zero indicates that the media surface is set to write permitted status.

The Media Cartridge Write Protection (CWP) bit of one indicates that the write protect switch/tabs on a cartridge is set to write protected state. The CWP bit of zero indicates that the write protect switch/tabs on a cartridge is set to write permitted state. This field is valid only when the Cartridge bit is set to one. If the Cartridge bit is set to zero, the CWP bit shall be set to zero.

The Disc Type Identification field indicates the Disc Type:

00h: A Disc shall not be written without a cartridge.

10h: A Disc may be written without a cartridge.

Others: Reserved

The DVD-RAM Specific Write Inhibition Information (RAM-SWI Information) field indicates the reason of DVD-RAM specific write inhibition status. This field is valid only when the MSWI bit is set to one.

If MSWI bit is set to one, RAM-SWI Information field shall be set according to Table 390.

Table 390 – RAM-SWI Information field definition

Value	Description
00h	Reserved
01h	Bare Disc Write Inhibition (Disc Type Identification field of 00h and no cartridge)
02h-Feh	Reserved
FFh	Unspecified reason

6.27.3.11 Format Code 0Ah: DVD-RAM Spare Area Information

The DVD-RAM Spare Area Information data returned is defined in Table 391.

Table 391 – READ DVD STRUCTURE Data Format (Format = 0Ah)

Byte	Bit	7	6	5	4	3	2	1	0
0	(MSB)	DVD STRUCTURE Data Length							
1		(LSB)							
2		Reserved							
3		Reserved							
DVD-RAM Spare Area Information									
0	(MSB)	Number of unused Primary Spare blocks							
1									
2									
3									
4	(MSB)	Number of unused Supplementary Spare blocks							
5									
6									
7									
8	(MSB)	Number of allocated Supplementary Spare blocks							
9									
10									
11									

When a READ DVD STRUCTURE command with the Format field value of 0Ah is issued for other than DVD media that is capable of allocation of the Supplementary Spare area, this command shall be terminated with CHECK CONDITION status and SK/ASC/ASCQ values shall be set to ILLEGAL REQUEST/INVALID FIELD IN CDB.

The Initiator may recognize whether the media is capable of allocation of the Supplementary Spare area or not, indicated in the Defect Management Feature Descriptor reported by the GET CONFIGURATION command.

The DVD STRUCTURE Data Length indicates the length in bytes of the following DVD Structure data that is available to be transferred to the Initiator. The DVD Structure Data Length value does not include the DVD STRUCTURE Data Length field itself.

The Number of unused Primary Spare blocks field indicates the number of unused spare blocks in the Primary Spare area.

The number of unused Supplementary Spare blocks field indicates the number of unused spare blocks in the Supplementary Spare area.

The number of allocated Supplementary Spare blocks field indicates the number of allocated spare blocks in the Supplementary Spare area.

6.27.3.12 Format Code 0Bh: DVD-RAM Recording Type Information

If a READ DVD STRUCTURE command with the Format code value of 0Bh is issued for other than DVD-RAM Ver.2.1 media, the command shall be terminated with CHECK CONDITION status and sense bytes SK/ASC/ASCQ shall be set to ILLEGAL REQUEST/INVALID FIELD IN CDB.

Table 392 – READ DVD STRUCTURE Data Format (Format = 0Bh)

Bit	7	6	5	4	3	2	1	0	
Byte									
0	(MSB) DVD STRUCTURE Data Length								
1								(LSB)	
2	Reserved								
3	Reserved								
DVD-RAM Recording Type Information									
0	Reserved			Recording Type	Reserved				
1	Reserved								
2	Reserved								
3	Reserved								

The DVD STRUCTURE Data Length field specifies the length in bytes of the following DVD Structure data that is available to be transferred to the Initiator. The DVD STRUCTURE Data Length value does not include the DVD STRUCTURE Data Length field itself.

The Recording Type bit is defined only for DVD-RAM Ver.2.1 media. The Recording Type bit, if set to 1b, indicates that this sector contains a real-time data. A value of 0b indicates that this sector contains a general data. The Streaming bit of the WRITE (12) command shall be used to set/clear the Recording Type bit.

6.27.3.13 Format Code 0Ch: RMD in the last Border-out

The RMD field recorded in the Border-out is defined in Table 393.

Table 393 – READ DVD STRUCTURE Data Format (Format field = 0Ch)

Bit	7	6	5	4	3	2	1	0
Byte								
0	(MSB) DVD STRUCTURE Data Length (LSB)							
1								
2	Reserved							
3	Reserved							
RMD in last Border-out								
0	RMD							
...								
n								

The DVD STRUCTURE Data Length specifies the length in bytes of the following DVD STRUCTURE data that is available to be transferred to the Initiator. The DVD STRUCTURE Data Length value does not include the DVD STRUCTURE Data Length field itself.

The RMD Bytes field returns the RMD that is written in the last recorded Border-out.

The Address field in the command specifies the starting RMD Field number where the read operation shall begin. The Allocation Length field in the command specifies the maximum number of RMD bytes that shall be returned. The largest RMD available is 30 720 bytes (15 sectors).

6.27.3.14 Format Code 0Dh: Recording Management Area Data

The DVD-R/-RW Recording Management Data Structure sectors recorded in the RMA, on the media, is identified with the data format defined in Table 394. This format is available only for DVD-R/-RW media. For other media, this format is reserved.

Table 394 – READ DVD STRUCTURE Data Format (Format field = 0Dh)

Bit	7	6	5	4	3	2	1	0
Byte								
0	(MSB) DVD STRUCTURE Data Length (LSB)							
1								
2	Reserved							
3	Reserved							
DVD-R/-RW Recording Management Data Structure								
0	(MSB) Last Recorded RMA Sector Number/ Start Sector Number of Valid Format 3 RMD Set (LSB)							
1								
2								
3								
4	RMD Bytes							
...								
n								

The DVD STRUCTURE Data Length specifies the length in bytes of the following DVD STRUCTURE data that is available to be transferred to the Initiator. The DVD STRUCTURE Data Length value does not include the DVD STRUCTURE Data Length field itself.

Last Recorded RMA Sector Number / Start Sector Number of Valid Format 3 RMD Set field indicates the RMA sector number where the last RMD is recorded. On DVD-RW restricted overwritten media, this field indicates the start sector number of valid Format 3 RMD Set.

The RMD Bytes field returns RMD that is written in RMA. The Address field in the command specifies the starting address of the RMA sector where the read operation shall begin. The Allocation Length field in the command specifies the maximum length of the descriptor returned to the Initiator. The returned RMD data shall end at the next ECC boundary.

The maximum number of RMD bytes that may be returned is 32768.

6.27.3.15 Format Code 0Eh: Pre-recorded Information in Lead-in

The Pre-recorded Information in Lead-in area recorded on the media is identified with a data format defined in Table 395. This format is available only for DVD-R/-RW media. For other media, this format is reserved.

Table 395 – READ DVD STRUCTURE Data Format (Format field = 0Eh)

Byte	Bit	7	6	5	4	3	2	1	0
0	(MSB)	DVD STRUCTURE Data Length							
1		(LSB)							
2		Reserved							
3		Reserved							
DVD-R Pre-recorded Information Structure									
0		Field ID (= 1)							
1		Disc Application code							
2		Disc Physical code							
3	(MSB)	Last address of Data Recordable Area							
4									
5									
6		Reserved (DVD-R/-RW Ver.1.0)							
		Part Version (R for General Ver.2.0/R for Authoring Ver.2.0)				Extension code (R for General Ver.2.0/R for Authoring Ver.2.0)			
7		Reserved							
8		Field ID (= 2)							
9		OPC Suggested Code							
10		Wavelength Code (all R media) / OPC suggested code (RW Ver.1.0)							
11 – 14		Write Strategy Code							
15		Reserved							
16		Field ID (= 3)							
17 – 22		Manufacturer ID							
23		Reserved							
24		Field ID (= 4)							
25 – 30		Manufacturer ID							
31		Reserved							
32		Field ID (= 5)							
33 – 38		Manufacturer ID (R Ver.1.0) / Write Strategy code (RW Ver.1.0 /R for General Ver.2.0/R for Authoring Ver.2.0)							
39		Reserved							
40 – 63		Reserved							

The DVD STRUCTURE Data Length specifies the length in bytes of the following DVD STRUCTURE data that is available to be transferred to the Initiator. The DVD STRUCTURE Data Length value does not include the DVD STRUCTURE Data Length field itself.

The contents of Pre-recorded information are specified by the DVD Specifications for Recordable Disc, Part 1 or DVD Specifications for Re-recordable Disc Part 1.

6.27.3.16 Format Code 0Fh: Unique Disc Identifier

The Unique Disc Identifier data recorded on the media is identified with a data format defined in Table 396. This format is available only for DVD-R/-RW media. For other media, this format is invalid and reserved.

Table 396 – READ DVD STRUCTURE Data Format (Format field = 0Fh)

Byte	Bit	7	6	5	4	3	2	1	0
0	(MSB)	DVD STRUCTURE Data Length							
1		(LSB)							
2		Reserved							
3		Reserved							
DVD-R/-RW Unique Disc Identifier									
0		Reserved							
1		Reserved							
2	(MSB)	Random Number							
3		(LSB)							
4	(MSB)	Year							
5									
6									
7		(LSB)							
8	(MSB)	Month							
9		(LSB)							
10	(MSB)	Day							
11		(LSB)							
12	(MSB)	Hour							
13		(LSB)							
14	(MSB)	Minute							
15		(LSB)							
16	(MSB)	Second							
17		(LSB)							

The DVD STRUCTURE Data Length specifies the length in bytes of the following DVD STRUCTURE data that is available to be transferred to the Initiator. The DVD STRUCTURE Data Length value does not include the DVD STRUCTURE Data Length field itself.

This format returns the Unique Disc Identifier that is recorded in RMD Field 0.

6.27.3.17 Format Code 10h: Format Information of Control Data Zone in the Lead-in

This format is available only for DVD-R/-RW media. For other media, this format is invalid and reserved.

This Format code returns Physical format information of Control Data Zone in the Lead-in area even if the disc is recorded with multi-bordered area.

Table 397 – READ DVD STRUCTURE Data Format (With Format field = 10h)

Byte	Bit	7	6	5	4	3	2	1	0	
0	Book Type				Part Version					
1	Disc Size				Maximum Rate					
2	Reserved	Number of Layers		Track Path		Layer Type				
3	Linear Density				Track Density					
4	00h									
5	(MSB)	Starting Physical Sector Number of Data Area							(LSB)	
6										
7										
8	00h									
9	(MSB)	End Physical Sector Number of Data Area							(LSB)	
10										
11										
12	00h									
13	(MSB)	End Physical Sector Number in Layer 0							(LSB)	
14										
15										
16	BCA	Reserved								
17 – 2047	Media Specific									

The Media Specific field shall return information as specified in the associated DVD specification.

The other field definitions are same as the definitions of Format code 00h.

6.27.3.18 Format Code 11h: ADIP Information

The information in this structure is formatted as in Format Code = 0, but uses unmodified ADIP information from the DVD+R/+RW disc. The format of the ADIP Information is shown in Table 398.

Table 398 – ADIP Information

Byte	Bit	7	6	5	4	3	2	1	0
0	(MSB)	DVD STRUCTURE Data Length							
1		(LSB)							
2		Reserved							
3		Reserved							
ADIP Information									
0		ADIP Information Block (see <i>DVD+R Basic Format Specifications</i> and <i>DVD+RW Basic Format Specifications</i>)							
1									
...									
255									

6.27.3.19 Format Code 30h: Disc Control Blocks**6.27.3.19.1 Overview**

A Disc Control Block is a structure on DVD+R/+RW media that specifies format or use information. Each Disc Control Block is up to 16 sectors in length. The DCB header is the first 40 bytes of the block. The DCB Header fields have a common definition, while the remaining bytes depend on the value of the Content Descriptor field (see Table 399). The Disc Control Blocks are defined in the *DVD+R 4,7 Gbytes Basic Formats Specifications* and the *DVD+RW 4,7 Gbytes Basic Formats Specifications*.

If a Disc Control Block, with fewer than 32 768 bytes is read, the Logical Unit shall pad the Disc Control Block with 00h bytes.

Table 399 – Generic Disc Control Block

Byte	Bit	7	6	5	4	3	2	1	0
0	(MSB)	Content Descriptor							
...									
3									
4	(MSB)	Unknown Content Descriptor Actions							
...									
7									
8 – 39		Vendor ID							
40 - 32 767		DCB Data							

The location of a DCB is dependent upon its content descriptor.

The Address field of the READ DVD STRUCTURE command shall contain a Content Descriptor to identify the Disc Control Blocks (DCB) requested. The Content Descriptor field identifies the contents of bytes 40 – 32 767. Valid values are shown in Table 400.

Table 400 – Valid Values for Content Descriptor

Content Descriptor	Definition
00000000h	Reserved
00000001h – FFFFFFFDh	The DCB with a matching Content Descriptor is returned
FFFFFFFEh	Reserved
FFFFFFFh	Return a list of readable and writable DCB Content Descriptors

The Unknown Content Descriptor Actions field contains a bit mask. This mask shall describe actions the Logical Unit is allowed to perform if the Logical Unit does not know the Content Descriptor. Each bit, when set to one, shall prohibit the corresponding action. When set to zero, the corresponding action is allowed.

Table 401 – Unknown Content Descriptor Actions

Bit	Actions
0	Recording within the user data area
1	Reading DCBs
2	Formatting of the medium
3	Modification of this DCB
4 –31	Reserved

The Vendor ID field contains 24 arbitrary bytes.

6.27.3.19.2 Formatting DCB (FDCB)

The FDCB (Content Descriptor = 46444300h) is a 32 768-byte read-only structure that aids the Logical Unit during background formatting. Refer to *DVD+RW 4,7 Gbytes Basic Formats Specifications* for specific content descriptions.

6.27.3.19.3 Write Inhibit DCB (WDCB)

The WDCB (Content Descriptor = 57444300h) is a 32 768 byte structure as shown in Table 402.

Table 402 – WDCB Format

Byte	Bit	7	6	5	4	3	2	1	0
0 – 39	DCB Header								
40 – 43	WDCB Update Count								
44 – 47	Write Protect Actions								
48 – 63	Reserved								
64 – 95	WDCB Password								
96 – 32 767	Reserved								

The DCB header format is shown in Table 399:

The WDCB Update Count is set to zero when the WDCB is created and incremented each time the WDCB is updated.

Write Protect Actions (Table 403) is a 32-bit field that defines the write protect acitons assigned to the DCB.

Table 403 – Write Protect Actions Field

Bit	Meaning
31	Reserved (0)
...	...
8	Reserved (0)
7	When zero (0), the WDCB is not password protected.

	When one (1), the WDCB is password protected.
6	Reserved (0)
...	...
2	Reserved (0)
1	Write Protect Status: 00b = Media is fully write enabled 01b = Writing in the data zone is not permitted
0	10b = Writing to a LBA space as defined by a hardware defect management system (e.g. MRW) is not permitted 11b = No writing (except WDCB changes) is permitted

The WDCB Password, when enabled, permits WDCB changes only when the correct password is supplied by the Initiator during a SEND DVD STRUCTURE command with format code = 30h (6.39.5). In the case of the READ DVD STRUCTURE command with format code = 30h, the WDCB password shall always be zero filled before WDCB information is transferred to the Initiator.

Refer to *DVD+RW 4,7 Gbytes Basic Formats Specifications* for specific field definitions.

6.27.3.19.4 Session DCB

If Session Number does not exist, the drive shall terminate the command with CHECK CONDITION status and set sense bytes SK/ASC/ASCQ to ILLEGAL REQUEST/INVALID PARAMETER IN CDB. The Session DCB (Content Descriptor = 53444300h) has two forms: Session descriptor and fragment descriptor. The Session form defines Session boundary information, while the Fragment form defines Fragment boundary and content information. The general structure of a SDCB is shown in Table 404.

Table 404 – SDCB Format

Byte	Bit	7	6	5	4	3	2	1	0
0 – 39		DCB Header							
40 – 41		Session Number							
42 – 63		Reserved							
64 – 95		Disc ID (in Lead-in SDCBs)							
96 – 127		Reserved							
128 – 8 191		Session Items							
8 192 – 32 767		3 Repetitions of bytes 0 through 8 191							

The DCB header format is shown in Table 399.

The Session Number identifies the session to which this SDCB belongs.

The Disc ID field contains a random 256-bit disc ID that is generated upon opening the first session.

The Session Items is a set of 16-byte session information records. The session information may contain session boundary and content data or fragment boundary and content information. Unused session items shall be zero filled. Used session items shall appear at the beginning of the list.

Detailed format information is found in *DVD+R 4,7 Gbytes Basic Formats Specifications*.

NOTE 21: The SDCB is read-only.

6.27.3.19.5 DCB List

When Content Descriptor FFFFFFFFh (Table 405) is requested, the Logical Unit shall generate a list of DCBs that may be read from and/or recorded on the current medium by the Initiator. If the Logical Unit records DCBs that are generated internally, and those DCBs may not be sent from the Initiator, the Logical Unit shall not report those DCBs as recordable.

Table 405 – Disc Control Block (FFFFFFFh)

Bit	7	6	5	4	3	2	1	0
Byte								
0	(MSB) Content Descriptor = FFFFFFFFh (LSB)							
...								
3								
4 – 7	Reserved							
8 – 39	Vendor ID							
40	Reserved							
41	Number of Readable DCBs (= M)							
42	Reserved							
43	Number of Recordable DCBs (= N)							
44	(MSB) Readable DCB 0 (LSB)							
45								
46								
47								
M * 4 + 40	(MSB) Readable DCB M-1 (LSB)							
M * 4 + 41								
M * 4 + 42								
M * 4 + 43								

Table 405 – Disc Control Block (FFFFFFFh) cont.

Bit	7	6	5	4	3	2	1	0
Byte								
M * 4 + 44	(MSB) Recordable DCB 0 (LSB)							
M * 4 + 45								
M * 4 + 46								
M * 4 + 47								
(M + N) * 4 + 40	(MSB) Recordable DCB N – 1 (LSB)							
(M + N) * 4 + 43								

The Content Descriptor field shall contain FFFFFFFFh.

The Unknown Content Descriptor Actions field shall be set to zero.

The Vendor ID field shall be set to the value the Logical Unit uses for its own DCBs.

The Number of Readable DCBs field shall identify the number of entries in the Readable DCB list.

The Number of Recordable DCBs field shall identify the number of entries in the Recordable DCB list.

Each Readable DCB field shall contain a Content Descriptor of a DCB that may be read from the medium.

Each Recordable DCB field shall contain a Content Descriptor of a DCB that may be sent from the Initiator. If a DCB is both readable and recordable, the DCB shall appear in both lists. The Logical Unit shall not record any DCB that it does not recognize.

6.27.3.20 Format Code 31h: Read MTA ECC Block

Format Code 31h permits for reading ECC blocks in the MTA. Support for Format Code 31h is optional since its only purpose is to aid in data recovery on media corrupted by an unexpected RESET or power-off.

If a Logical Unit supports Format Code 31h, it shall return data from ECC blocks within the MTA addressed by PSN. A specific ECC block may be read by placing its PSN in the Address field of the CDB. Valid PSNs are 02DE80h through 02EEBFh and 02EFC0h through 02EFFFh. If the Address field contains any other PSN, the command shall be terminated with CHECK CONDITION and sense data shall be set to ILLEGAL REQUEST/INVALID FIELD IN CDB.

The format of returned data for Format Code 31h is shown in Table 406.

Table 406 – READ DVD STRUCTURE Data Format (Format field = 31h)

Bit	7	6	5	4	3	2	1	0	
Byte									
0	(MSB) DVD STRUCTURE Data Length								
1									(LSB)
2	Reserved								
3	Reserved								
MTA Block Data									
0 ... 32 767	Addressed MTA ECC Block data								

6.27.3.21 Format Code C0h: Write Protection Status

The Write protection status is returned in the format as shown in Table 407.

Table 407 – READ DVD STRUCTURE Data Format (Format field = C0h)

Byte	Bit	7	6	5	4	3	2	1	0	
0	(MSB)	DVD STRUCTURE Data Length								
1		(LSB)								
2		Reserved								
3		Reserved								
Write Protection Status										
0		Reserved				MSWI	CWP	PWP	SWPP	
1		Reserved								
2		Reserved								
3		Reserved								

The DVD STRUCTURE Data Length field specifies the length in bytes of the following DVD STRUCTURE data that is available to be transferred to the Initiator. The DVD STRUCTURE Data Length value does not include the DVD STRUCTURE Data Length field itself.

The Software Write Protection until Power down (SWPP) bit of one indicates that the software write protection is active. The SWPP bit of zero indicates that the software write protection is inactive. If the Logical Unit does not support SWPP, this bit shall be set to zero.

The Persistent Write Protection (PWP) bit of one indicates that the media surface is set to write protected status. The PWP bit of zero indicates that the media surface is set to write permitted status. If the mounted medium and Logical Unit do not support PWP, this bit shall be set to zero. If Write Inhibit is implemented via a WDCB, then any write inhibit action specified in the WDCB shall result in PWP set to one (see).

The Media Cartridge Write Protection (CWP) bit of one indicates that the write protect switch/tabs on a cartridge is set to write protected state. The CWP bit of zero indicates that the write protect switch/tabs on a cartridge is set to write permitted state. If the cartridge does not have CWP function or medium is mounted without cartridge, this bit shall be set to zero. Otherwise, CWP bit shall indicate its actual status.

The Media Specific Write Inhibition (MSWI) bit of one indicates that any writing is inhibited by the media specific reason. The MSWI bit of zero indicates that writing is not inhibited by the media specific reason.

6.27.3.22 Format Code FFh: DVD Structure List

The DVD Structure List is returned in the format as shown in Table 408.

Table 408 – READ DVD STRUCTURE Data Format (Format field = FFh)

Bit	7	6	5	4	3	2	1	0
Byte								
0	(MSB) DVD STRUCTURE Data Length (LSB)							
1								
2	Reserved							
3	Reserved							
DVD Structure List								
0 - n	Structure List							

The DVD STRUCTURE Data Length specifies the length in bytes of the following DVD STRUCTURE data that is available to be transferred to the Initiator. The DVD STRUCTURE Data Length value does not include the DVD STRUCTURE Data Length field itself.

The Structure List is returned as a sequence of Structure List Entries as shown in Table 409.

This DVD Structure is generated by the Logical Unit rather than read from the medium. Consequently, this structure shall be returned regardless of media presence.

Table 409 – Structure List Entry

Bit	7	6	5	4	3	2	1	0
Byte								
0	Format Code							
1	SDS	RDS	Reserved					
2	(MSB) Structure Length (LSB)							
3								

The Format Code field shall identify a DVD Structure that is readable via the READ DVD STRUCTURE command.

The SDS bit, when set to zero, shall indicate that the DVD structure is not writable via the SEND DVD STRUCTURE command. When set to one, shall indicate that the DVD structure is writable via the SEND DVD STRUCTURE command.

The RDS bit, when set to zero, shall indicate that the DVD structure is not readable via the READ DVD STRUCTURE command. When set to one, shall indicate that the DVD structure is readable via the READ DVD STRUCTURE command.

The Structure Length field shall specify the length of the DVD Structure that is identified by the Format Code.

6.27.4 Timeouts

The READ DVD STRUCTURE command belongs to timeout group 1. If the command is terminated with CHECK CONDITION status due to a timeout, sense bytes SK/ASC/ASCQ shall be set to UNIT ATTENTION/INSUFFICIENT TIME FOR OPERATION.

6.27.5 Error Reporting

Recommended error reporting for the READ DVD STRUCTURE command is defined in Table 410.

Table 410 – Recommended errors for READ DVD STRUCTURE Command

Error	Reference
Unit Attention conditions	Table F.1
CDB or parameter list validation errors	Table F.2
Readiness errors	Table F.3
General media access errors	Table F.5
Read errors	Table F.6
Hardware failures	Table F.8

6.28 READ FORMAT CAPACITIES Command

6.28.1 Introduction

The READ FORMAT CAPACITIES command allows the Initiator to request a list of the possible format capacities for an installed writable media. This command also has the capability to report the writable capacity for a media when it is installed. For readable capacity, see 6.23, READ CAPACITY Command. If the command is required, by an implemented Feature it shall function independently of the state of that Feature's Current bit.

Table 411 shows the Features associated with the READ FORMAT CAPACITIES command.

Table 411 – Features Associated with the READ FORMAT CAPACITIES Command

Feature Number	Feature Name	Command Requirement
0023h	Formattable	Mandatory
0028h	MRW	Mandatory

6.28.2 The CDB and Its Parameters

6.28.2.1 The CDB

The READ FORMAT CAPACITIES CDB is shown in Table 412.

Table 412 – READ FORMAT CAPACITIES CDB

Bit	7	6	5	4	3	2	1	0
0	Operation Code (23h)							
1	Reserved							
2	Reserved							
3	Reserved							
4	Reserved							
5	Reserved							
6	Reserved							
7	(MSB)	Allocation Length						(LSB)
8								
9	Control							

The Allocation Length field specifies the maximum number of bytes that an Initiator has allocated for returned data. An Allocation Length of zero indicates that no data shall be transferred. This condition shall not be considered as an error. The Logical Unit shall terminate the data transfer when Allocation Length bytes have been transferred or when all available data have been transferred to the Initiator, whatever is less.

6.28.3 Command Execution

The Logical Unit shall construct a set of data structures that shall be transferred to the Initiator. The format of this returned data is a 4-byte header followed by some non-zero number of 8-byte format descriptors as shown in Table 413.

Table 413 – READ FORMAT CAPACITIES Data Format

Bit	7	6	5	4	3	2	1	0
Byte								
0 – 3	Capacity List Header							
4 – 11	Current/Maximum Capacity Descriptor							
Formattable Capacity Descriptor(s)								
0	Formattable Capacity Descriptor 0							
..								
7								
....								
0	Formattable Capacity Descriptor n							
..								
7								

6.28.3.1 Capacity List Header

The Capacity List Header precedes all other returned data.

Table 414 – Capacity List Header

Bit	7	6	5	4	3	2	1	0
Byte								
0	Reserved							
1	Reserved							
2	Reserved							
3	Capacity List Length							

The Capacity List Length specifies the length in bytes of the available Capacity Descriptors that follow.

Each Capacity Descriptor is eight bytes in length, making the Capacity List Length equal to eight times the number of descriptors. Values of $n * 8$ are valid, where $0 < n < 32$.

6.28.3.2 Current/Maximum Capacity Descriptor

The Current/Maximum Capacity Descriptor shall appear after the header.

Table 415 – Current/Maximum Capacity Descriptor

Bit	7	6	5	4	3	2	1	0
Byte								
4	(MSB) Number of Blocks (LSB)							
5								
6								
7								
8	Reserved					Descriptor Type		
9	(MSB) Block Length (LSB)							
10								
11								

The Number of Blocks indicates the number of addressable blocks for the capacity defined by each Descriptor Type.

The Descriptor Type field (Table 416) indicates the type of information the descriptor contains.

The Block Length specifies the length in bytes of each logical block.

Table 416 – Descriptor Types

Descriptor Type	Description
00b	Reserved
01b	Unformatted Media. The reported value is for the maximum formatted capacity for this media. See Table 417.
10b	Formatted Media. The reported value is the current media's capacity. In the case of sequential writable media, the number of blocks field indicates the number of blocks between the first Lead-in and the last Lead-out/Border-out. When the media does not have a complete session it shall be reported as "No Media Present" with Descriptor Type = 11b.
11b	No Media Present. The reported value is for the maximum capacity of a media that the Logical Unit is capable of reading.

Table 417 – Returned Current/Maximum Descriptor for Combination of Logical Unit and Media

Logical Unit Type	No Media	ROM Media	Sequential Writable Media	Random Writable Media
ROM	Descriptor Type = 11h	Descriptor Type = 10h	Descriptor Type = 10h or 11h	Descriptor Type = 10h
Sequential Writable			Descriptor Type = 10h	Descriptor Type = 10h
Random Writable			Descriptor Type = 10h or 11h	Descriptor Type = 01h or 10h plus Formattable Capacity Descriptor(s)

6.28.3.3 Formattable Capacity Descriptors

The Logical Unit shall only return Formattable Capacity Descriptors that apply to the installed media. If there is no medium installed, the Logical Unit shall return only the Current/Maximum Capacity Descriptor, with the maximum capacity of a medium that the Logical Unit is capable of reading.

A Formattable Capacity Descriptor of Format Type 00h shall be reported if any other Formattable Capacity Descriptor is reported. Although the Logical Unit may not support formatting type 0 (e.g. CD-RW), the descriptor is reported for the purpose of reporting the recordable capacity of sequentially recorded media.

The descriptors shall be returned in ascending order of Format Type. For Format Types other than 04h and 05h, if multiple format descriptors exist, they shall be returned in Logical Unit preferred order. For Format Types 04h and 05h, the format descriptors shall be returned in ascending order of Zone number.

Formattable Capacity Descriptors for formats that may be read, but not formatted shall not be reported.

If the Logical Unit supports writing on the mounted media, the appropriate Formattable Capacity Descriptors shall be appended, sorted by Format Type. The general format of a Formattable Capacity Descriptor is shown in Table 418.

Table 418 – Formattable Capacity Descriptor Format

Bit	7	6	5	4	3	2	1	0	
Byte									
0	(MSB)								
1	Number of Blocks								
2									
3									(LSB)
4	Format Type					Reserved			
5	(MSB)								
6	Type Dependent Parameter								
7									(LSB)

The Format Type field, Table 419 is the type of information required for formatting.

Table 419 – Format Types

Format Type	Description	Type Dependent Parameter
00h	The descriptor shall contain the number of addressable blocks and the block size used for formatting the whole media. If multiple formatting for the whole media is possible, each capacity/block size combination shall be reported as a separate descriptor.	Block length in bytes
01h	The descriptor shall contain the number of addressable blocks and the block size used for formatting the whole media. If multiple formatting for the whole media is possible, each capacity/block size combination shall be reported as a separate descriptor. This Format Type is used to expand a Spare area.	Block length in bytes
02h – 03h	Reserved	
04h	The descriptor shall contain the number of addressable blocks in the zone and zone number used by zoned formatting for a zone of the media, where the size of zone is not constant for each zone. The information for each zone shall be reported as a separate descriptor.	Zone number of the description
05h	The descriptor shall contain the number of addressable blocks per zone and zone number of the highest numbered zone. This descriptor is used for zoned formatting of the media, where the size of zone is constant for each zone.	Zone number of the last zone
06h – 0Fh	Reserved	
10h	The descriptor shall contain the maximum number of addressable blocks and maximum packet size that may be used to fully format CD/DVD-RW media. The packet size and number of addressable blocks may be adjusted downward by the Initiator before sending this descriptor back via the FORMAT UNIT command.	Fixed Packet Size in sectors/ECC block size in sectors
11h	The descriptor shall contain the maximum number of addressable blocks and the packet size that may be used to expand (grow) the last complete session of CD/DVD-RW media. The number of addressable blocks may be adjusted downward by the Initiator before sending this descriptor back via the FORMAT UNIT command.	Fixed Packet Size in sectors/ECC block size in sectors
12h	The descriptor shall contain the maximum number of addressable blocks and the maximum packet size that may be used to add a new session to a CD/DVD-RW media. The packet size and number of addressable blocks may be adjusted downward by the Initiator before sending this descriptor back via the FORMAT UNIT command.	Fixed Packet Size in sectors/ECC block size in sectors
13h	The descriptor shall contain the maximum number of addressable blocks and the ECC block size that may be used to expand (grow) the last complete Session of DVD-RW media as an intermediate state. The Initiator may adjust the number of addressable blocks downward before sending this descriptor back via the FORMAT UNIT command.	ECC block size in sectors
14h	The descriptor shall contain the maximum number of addressable blocks and the ECC block size that may be used to add a new intermediate state Session to a DVD-RW media. The number of addressable blocks may be adjusted downward by the Initiator before sending this descriptor back via the FORMAT UNIT command.	ECC block size in sectors
15h	The descriptor shall contain the maximum number of addressable blocks and ECC block size that may be used to fully format DVD-RW media as an intermediate state. The number of addressable blocks may be adjusted downward by the Initiator before sending this descriptor back via the FORMAT UNIT command.	ECC block size in sectors
16h – 20h	Reserved	
21h-23h	Reserved	

Table 419 – Format Types (continued)

Format Type	Description	Type Dependent Parameter
24h	MRW Format, Mandatory for the MRW Feature. The descriptor shall contain the maximum number of DMA addressable blocks.	The Type Dependent Parameter is not used and shall be set to zero.
26h	DVD+RW Full Format, Mandatory for the DVD+RW Profile	The Type Dependent Parameter is not used and shall be set to zero.
25h – 3Fh	Reserved	

The Number of Blocks field indicates the number of addressable blocks for the capacity defined by each Format Type.

The Type Dependent Parameter contents are as specified for each Format Type in Table 419.

6.28.4 Timeouts

The READ FORMAT CAPACITIES command belongs to timeout group 1. If the command is terminated with CHECK CONDITION status due to a timeout, sense bytes SK/ASC/ASCQ shall be set to UNIT ATTENTION/INSUFFICIENT TIME FOR OPERATION.

6.28.5 Error Reporting

Recommended error reporting for the READ FORMAT CAPACITIES command is defined in Table 420.

Table 420 – Recommended errors for READ FORMAT CAPACITIES Command

Error	Reference
Unit Attention conditions	Table F.1
CDB or parameter list validation errors	Table F.2
General media access errors	Table F.5
Hardware failures	Table F.8

6.29 READ SUB-CHANNEL Command

6.29.1 Introduction

The READ SUB-CHANNEL command requests that the Logical Unit return the requested Sub-channel data.

Table 421 shows the Features associated with the READ SUB-CHANNEL command.

Table 421 – Features Associated with the READ SUB-CHANNEL Command

Feature Number	Feature Name	Command Requirement
0103h	CD Audio External Play	Mandatory

6.29.2 The CDB and Its Parameters

6.29.2.1 The CDB

The READ SUB-CHANNEL CDB is shown in Table 422.

Table 422 – READ SUB-CHANNEL CDB

Bit	7	6	5	4	3	2	1	0	
0	OPERATION CODE (42h)								
1	Reserved						TIME	Resvd	
2	Resvd	SUBQ	Reserved						
3	Sub-channel Parameter List								
4	Reserved								
5	Reserved								
6	Track Number								
7	(MSB)	Allocation Length							
8								(LSB)	
9	Control								

6.29.2.2 TIME

When the TIME bit is set to zero, the address fields in returned data shall be in LBA form. When TIME is set to one, the address field in returned data shall be in TIME form. See Table 29 for TIME format.

6.29.2.3 SUBQ

When the SUBQ bit is set to one, the Logical Unit shall return the Q Sub-channel data. When the SUBQ bit is set to zero, the Logical Unit shall return no Sub-channel data. This shall not be considered an error.

6.29.2.4 Sub-channel Parameter List

The Sub-channel parameter list (Table 423) field specifies the returned sub channel data.

Table 423 – Sub-channel Parameter List Codes

Format Code	Returned Data
00h	Reserved
01h	CD current position
02h	Media Catalog number (UPC/bar code)
03h	International standard recording code (ISRC)
04h – FFh	Reserved

6.29.2.5 Track Number

The Track Number field specifies the track number from which ISRC data is read. This field shall have a value between 01h and 63h, and is valid only when the Sub-channel Parameter List field is 03h. In this case, the Logical Unit returns ISRC data for this track. The Logical Unit shall ignore this field when the Format code is not 03h.

Although track number is represented on CD media in BCD, the Track Number field representation in the CDB shall be the binary equivalent.

6.29.2.6 Allocation Length

The Allocation Length field specifies the maximum number of bytes that may be returned by the Logical Unit. An Allocation Length field of zero shall not be considered an error.

6.29.3 Command Execution

6.29.3.1 Overview

The data returned is formatted as a header followed by zero or more bytes of the requested sub-channel. See Table 424.

Table 424 – Read Sub-Channel Returned Data Format

Bit	7	6	5	4	3	2	1	0
Byte								
0 – 7	Sub-channel Data Header							
8 – n	Sub-channel data							

6.29.3.2 Sub-Channel Data Header

The Sub-channel data header format (Table 425) is four bytes.

Table 425 – Sub-Q Channel Data Header Format

Bit	7	6	5	4	3	2	1	0	
Byte									
0	Reserved								
1	Audio Status								
2	(MSB)	Sub-channel Data Length							
3								(LSB)	

The audio status field indicates the status of audio play operations. The audio status values are defined in Table 426. Logical Units that do not support audio play operations shall always report 00h.

For Logical Units that support audio operations: The initial value for audio status is 15h. Audio status values 13h and 14h return information on previous audio operations. When audio play stops due to an error and the IMMED bit in the CD Audio Control Mode Page (see 7.5) is set to one, the Logical Unit shall report 14h in this audio status byte and shall report no deferred error.

Table 426 – Audio status codes

Status	Description
00h	Audio status byte not supported or not valid
01h – 10h	Reserved
11h	Audio play operation in progress
12h	Audio play operation paused
13h	Audio play operation successfully completed
14h	Audio play operation stopped due to error
15h	No current audio status to return
16h – FFh	Reserved

The Sub-channel data length field specifies the length in bytes of the following Sub-channel data block. A Sub-channel data length of zero indicates that no Sub-channel data block is included in the returned data. Sub-channel data length does not include the sub channel header. If the CDB SubQ bit is zero, the Logical Unit shall return only the Sub-channel data header. In this case, the Sub-channel data length is 0.

6.29.3.3 CD Current Position

Table 427 defines the response data format for the CD current position data format.

Table 427 – CD current position data format

Byte	Bit	7	6	5	4	3	2	1	0	
0	Sub-channel Data Format Code (01h)									
1	ADR				CONTROL					
2	TRACK NUMBER									
3	INDEX NUMBER									
4	(MSB)	Absolute CD Address							(LSB)	
7										(LSB)
8	(MSB)	Track Relative CD Address								
11										(LSB)

The ADR field gives the type of information encoded in the Q Sub-channel of this block, as shown in Table 428.

Table 428 – ADR Q Sub-channel field

ADR Code	Description
0h	Q Sub-channel mode information not supplied
1h	Q Sub-channel encodes current position data (i.e., track, index, absolute address, relative address)
2h	Q Sub-channel encodes media catalog number
3h	Q Sub-channel encodes ISRC
4h – Fh	Reserved

The control field is described in Table 429.

The bits of the control field (except for the copy bit) may change during an actual pause (X=00) of at least 2 seconds and during the Lead-in area only.

Table 429 – Q Sub-channel control field

Field	Definitions
00x0b	2 audio channels without pre-emphasis
00x1b	2 audio channels with pre-emphasis of 50/15 μ s
10x0b	audio channels without pre-emphasis (reserved in CD-R/RW)
10x1b	audio channels with pre-emphasis of 50/15 μ s (reserved in CD-R/RW)
01x0b	Data track, recorded uninterrupted
01x1b	Data track, recorded incremental
11xxb	Reserved
xx0xb	digital copy prohibited
xx1xb	digital copy permitted

Table 430 – Q Sub-channel control field for DDCD

Field	Definitions
0100b	Data track, recorded uninterrupted or recorded incremental

The Track Number field contains the current track number.

The Index Number field contains the current index number.

The Absolute CD Address field gives the current location relative to the logical beginning of the media. If the CDB TIME bit is zero, this field is an LBA. If the TIME bit is one, the address is TIME. See Table 29 for format of the Absolute CD Address field.

The Track Relative CD Address field gives the current location relative to the logical beginning of the current track. If the CDB TIME bit is zero, this field is a track relative LBA. If the current block is in the pre-gap area of a track, this is a negative value, expressed as a two's-complement number. If the TIME bit is set to one, this field is the relative TIME address from the Q Sub-channel formatted according to Table 29.

The control data and current position data is obtained from the Q Sub-channel information of the current block. Identification data may be reported that was obtained from a previous block. If identification data is reported, the data shall be valid for the sector addressed by the current position data.

- a) If an audio play operation is proceeding in the background, position data for the last sector played shall be reported.
- b) In other cases, for instance after a READ command, the Logical Unit may either report position data for the last sector processed for that operation or may report position data from the sector at the current read head position.

NOTE 22: When the type of information encoded in the Q Sub-channel of the current sector is the media catalog number or ISRC, the track, index, and address fields should be extrapolated from the previous sector.

6.29.3.4 Media Catalog Number

When the Sub-channel format code is 02h, the data returned is the Media Catalog Number (MCN). Table 431 defines the media catalog number returned data format.

Table 431 – Media Catalog Number data format

Byte	Bit	7	6	5	4	3	2	1	0
0	Sub-channel Data Format Code (02h)								
1	Reserved								
2	Reserved								
3	Reserved								
4	MCVAL	Reserved							
5	MCN byte N1 (Most significant)								
6	MCN byte N2								
7	MCN byte N3								
...	...								
16	MCN byte N12								
17	MCN byte N13 (Least significant)								
18	Zero								
19	AFRAME								

Sub-channel Data Format Code shall be set to 02h.

If MCN data is found on the media, the MCVAl bit shall be set to one. If no MCN is detected on the media, the MCVAl bit shall be set to zero.

The MCN is formatted as ASCII characters and placed in byte 5 (□bytes□ as N1) through through byte 17 (□bytes□ as N13). Media Catalog Number may be from any block that has MCN Q Sub-channel data. See 4.2.4.5.3. If MCVAl is zero, N1 through N13 should be filled with ASCII zeros.

The Zero field shall be filled with 00h.

AFRAME may return the frame number where the MCN was found. This shall be a value from 00h to 4Ah. All other values are reserved.

6.29.3.5 International Standard Recording Code (ISRC)

When the Sub-channel format code is 03h, the data returned is the track ISRC. This field contains the identifying number of the CDB requested track according to the ISRC standards (DIN-31-621) expressed in ASCII. Table 432 defines the Track International Standard Recording Code data format. A unique ISRC may exist for each track.

Table 432 – Track International Standard Recording Code data format

Byte	Bit	7	6	5	4	3	2	1	0
0	Sub-channel Data Format Code (03h)								
1	ADR				CONTROL				
2	Track Number								
3	Reserved								
4	TCVAL	Reserved							
5	Country Code: I1								
6	I2								
7	Owner Code: I3								
8	I4								
9	I5								
10	Year of Recording: I6								
11	I7								
12	Serial Number: I8								
13	I9								
14	I10								
15	I11								
16	I12								
17	Zero								
18	AFRAME								
19	Reserved								

Sub-channel Data Format Code shall be set to 03h.

The ADR and control fields shall be returned from the ADR and Control fields on the media.

The Track Number shall indicate the track from which the ISRC was requested.

If ISRC data is detected, the TCVAL bit shall set to one. If ISRC data is not detected, the TCVAL bit shall be set to zero.

Track ISRC data may be from any block in the specified track that has ISRC data. The ISRC is 12 characters long (represented by I1 to I12, see Table 432). ISRC data returned is encoded as ASCII characters according to the translation specified in Table 13 where:

- Country Code: 'A' – 'Z' (41h – 5Ah)
- Owner Code: '0' – '9' and 'A' – 'Z' (30h – 39h, 41h – 5Ah)
- Year of Recording: '0' – '9' (30h – 39h)
- Serial Number: '0' – '9' (30h – 39h)

The Zero field shall filled with 00h.

AFRAME may return the frame number in that the MCN was found. This shall be a value from 00h to 4Ah. All other values are reserved.

6.29.4 Timeouts

The READ SUB-CHANNEL command belongs to timeout group 1. If the command is terminated with CHECK CONDITION status due to a timeout, sense bytes SK/ASC/ASCQ shall be set to UNIT ATTENTION/INSUFFICIENT TIME FOR OPERATION.

6.29.5 Error Reporting

Recommended error reporting for the READ SUB-CHANNEL command is defined in Table 433.

Table 433 – Recommended errors for READ SUB-CHANNEL Command

Error	Reference
Unit Attention conditions	Table F.1
CDB or parameter list validation errors	Table F.2
Readiness errors	Table F.3
General media access errors	Table F.5
Read errors	Table F.6
Hardware failures	Table F.8

6.30 READ TOC/PMA/ATIP Command

6.30.1 Introduction

The READ TOC/PMA/ATIP command requests that the Logical Unit read data from a Table of Contents, the Program Memory Area (PMA), or the Absolute Time in Pre-Grove (ATIP) from CD media, format according to CDB parameters and transfer the resulting \square byte to the Initiator. For media other than CD, information may be fabricated in order to emulate a CD structure for the specific media.

Table 434 shows the Features associated with the READ TOC/PMA/ATIP command.

Table 434 – Features Associated with the READ TOC/PMA/ATIP Command

Feature Number	Feature Name	Command Requirement
001Eh	CD Read	Format Codes 0, 1, 2 and conditionally 5
001Fh	DVD Read	Format codes 0 and 1
0030h	DDCD Read	Format codes 0, 1, and 2
0103h	CD Audio External Play	Format codes 0 and 1

6.30.2 The CDB and Its Parameters

6.30.2.1 The CDB

The READ TOC/PMA/ATIP CDB is shown in Table 435.

Table 435 – READ TOC/PMA/ATIP CDB

Byte	Bit	7	6	5	4	3	2	1	0	
0		OPERATION CODE (43h)								
1		Reserved						TIME	Reserved	
2		Reserved				Format				
3		Reserved								
4		Reserved								
5		Reserved								
6		Track/Session Number								
7	(MSB)	Allocation Length								
8										
9		Control (LSB)								

6.30.2.2 TIME

When TIME is set to zero, the address fields in some returned data formats shall be in LBA form. When TIME is set to one, the address fields in some returned data formats shall be in TIME form. For specific cases, see Table 436.

6.30.2.3 Format

The Format field is used to select specific returned data format. See Table 436.

6.30.2.4 Track/Session Number

The Track/Session Number field provides a method to restrict the returned of some data formats to a specific session or a track range. See Table 436.

6.30.2.5 Allocation Length

The Allocation Length field specifies the maximum number of bytes that may be returned by the Logical Unit. An Allocation Length field of zero shall not be considered an error.

Table 436 – Format Field Values

Format Field	TIME Field	Track/Session Number	Description
0000b	Valid	Valid as a Track Number	The Track/Session Number field specifies starting track number for which the data is returned. For multi-session discs, TOC data is returned for all sessions. Track number AAh is reported only for the Lead-out area of the last complete session.
0001b	Valid	Ignored by Logical Unit	This format returns the first complete session number, last complete session number and last complete session starting address. In this format, the Track/Session Number field is reserved and should be set to 00h. NOTE: This format provides the Initiator access to the last closed session starting address quickly.
0010b	Ignored by Logical Unit	Valid as a Session Number	This format returns all Q sub-code data in the Lead-In (TOC) areas starting from a session number as specified in the Track/Session Number field. In this mode, the Logical Unit shall support Q Sub-channel POINT field value of A0h, A1h, A2h, Track numbers, B0h, B1h, B2h, B3h, B4h, C0h, and C1h. There is no defined LBA addressing and TIME bit shall be set to one.
0011b	Ignored by Logical Unit	Ignored by Logical Unit	This format returns Q sub-channel data in the PMA area. In this format, the Track/Session Number field is reserved and shall be set to 00h. There is no defined LBA addressing and TIME bit shall be set to one.
0100b	Ignored by Logical Unit	Ignored by Logical Unit	This format returns ATIP data. In this format, the Track/Session Number field is reserved and shall be set to 00h. There is no defined LBA addressing and TIME bit shall be set to one.
0101b	Ignored by Logical Unit	Ignored by Logical Unit	This format returns CD-TEXT information that is recorded in the Lead-in area as R-W Sub-channel Data.
0110b – 1111b	Reserved		

6.30.3 Command Execution

6.30.3.1 Overview

The response data list (see Table 437) shows the general description of the response data to the Read TOC/PMA/ATIP command. Each descriptor field is format specific and is defined in the appropriate format sub-clause.

Table 437 – READ TOC/PMA/ATIP Data list, general definition

Bit	7	6	5	4	3	2	1	0
Byte								
0	(MSB) Data Length (LSB)							
1								
2	First Track/Session/Reserved Field							
3	Last Track/Session/Reserved Field							
Parameter List Descriptor(s)								
0 : n	Descriptor data - format specific							

The Data Length indicates the length, in bytes, of the data list descriptor data.

The Track/Session/Reserved Field is format specific and indicates the location, if any, of the

information in the data list descriptors. These numbers are represented as binary values.

Descriptor data fields are format specific. The definitions of the bytes are described in each format sub-clause.

6.30.3.2 Response Format 0000b: Formatted TOC

6.30.3.2.1 General

The response data consist of four header bytes and zero or more track descriptors. The response data is dependent upon the format specified in the format field of the CDB. The response data returned for Format 0000b is specified in Table 438.

Table 438 – READ TOC/PMA/ATIP response data (Format = 0000b)

Bit	7	6	5	4	3	2	1	0	
Byte									
0	(MSB) TOC Data Length								
1									(LSB)
2	First Track Number								
3	Last Track Number								
TOC Track Descriptor(s)									
0	Reserved								
1	ADR				CONTROL				
2	Track Number								
3	Reserved								
4	(MSB) Track Start Address								
...									
7									(LSB)

The TOC data length indicates the length in bytes of the following TOC data. The TOC data length value does not include the TOC data length field itself. This value is not modified when the allocation length is insufficient to return all of the TOC data available. All other values within the descriptor shall be in binary representation.

6.30.3.2.2 General Case for CD

The First Track Number field indicates the first track number in the first complete session Table of Contents.

The Last Track Number field indicates the last track number in the last complete session Table of Contents before the Lead-out.

The ADR field (Table 428) gives the type of information encoded in the Q Sub-channel of the block where this TOC entry was found.

The Control Field (Table 429) indicates the attributes of the track.

The Track Start Address contains the address of the first block with user information for that track number as read from the Table of Contents. A TIME bit of zero indicates that the Track Start Address field shall contain a logical block address. A TIME bit of one indicates the Logical Block Address field shall contain a TIME address (see 4.1.6).

The Track Number field indicates the track number for that the data in the TOC track descriptor is valid. A track number of AAh indicates that the track descriptor is for the start of the Lead-out area.

6.30.3.2.3 MRW Deviations

If the disc is MRW formatted or in progress with MRW formatting, form 0 of the TOC shall be reported as follows: One track, track number = 1, ADR = 0001b, and CONTROL = 0111b. In the case of CD-MRW, the track start addresses are shown in Table 439. In the case of DVD+MRW, the track start addresses are shown in Table 440.

Table 439 – Track Start Addresses for CD-MRW Discs

LBA Space	TIME bit	Track 1 Start Address	Lead-out Start Address
GAA	1	00:02:00	Regardless of the state of the MRW formatting process, only the final state is reported. The link separating the last GAA packet and the first DMA packet is reported: 00:18:43.
GAA	0	0	1 024
DMA	1	00:18:47	Regardless of the state of the MRW formatting process, only final state is reported. The absolute address of the final state link block separating the last DMA packet and the first STA packet is reported.
DMA	0	0	C+1, where C is the LBA of the last user block of the last packet in the DMA.

Table 440 – Track Start Addresses for DVD+MRW Discs

LBA Space	TIME bit	Track 1 Start Address	Lead-out Start Address
GAA	1	00:02:00	Regardless of the state of the MRW formatting process, only the final state is reported. For the GAA, this address is 00:15:49.
GAA	0	0	1 024
DMA	1	00:02:00	The HMSF value shall be 00h, FFh, 3Bh, 4Ah
DMA	0	0	C+1, where C is the LBA of the last user sector of the last ECC block in the DMA.

6.30.3.2.4 DDCD Deviations

For DDCD, the control field is always set to 0100b.

6.30.3.2.5 DVD-ROM, DVD-RAM, DVD+RW, and Single Session DVD-R/-RW, DVD+R

TOC form 0 data for single session DVD shall be fabricated as shown in Table 441.

Table 441 – Fabrication of TOC Form 0 for Single Session DVD

Byte(s)	Field	Value
0, 1	TOC Data Length	001Ah
2	First Track	01h
3	Last Track	01h
Track 1 Descriptor		
4	Reserved	00h
5	ADR, CONTROL	17h: DVD+R and DVD+MRW 14h: all others
6	Track Number	01h
7	Reserved	00h
8...11	Track Start Address	LBA form = 000000h, TIME form = 00:00:02:00
Track AAh (Lead-out) Descriptor		
12	Reserved	00h
13	ADR, CONTROL	14h: DVD-ROM 17h: Recordables and Rewritables
14	Track Number	AAh
15	Reserved	00h
16...19	Track Start Address	LBA form = Actual start of lead-out, TIME form = HMSF translation of LBA with a maximum of TIME address of 00h, FFh, 3Bh, 4Ah

6.30.3.2.6 DVD-R/-RW with Multiple Sessions

DVD-R/-RW may have multiple sessions. Since the number of sessions may be rather large, only two sessions are represented as tracks: the last session is seen as the last user track. All earlier sessions are concatenated into a single logical track to be referred to as track 1. TOC form 0 shall be fabricated accordingly.

6.30.3.2.7 DVD+R with Multiple Sessions

Due to track merging, TOC form 0 reports each closed session as a track. Since DVD+R supports at most 154 sessions, TOC form 0 may have at most 154 track descriptors. Thus, the maximum size of returned data for TOC form 0 is 1 532 (i.e., 4 + 8*154).

6.30.3.3 Response Format 0001b: Multi-session Information

6.30.3.3.1 General

The response data returned for Format 0001b is specified in Table 442.

Table 442 – READ TOC/PMA/ATIP response data (Format = 0001b)

Byte	Bit	7	6	5	4	3	2	1	0
0	(MSB)	TOC Data Length							
1		(LSB)							
2		First Complete Session Number							
3		Last Complete Session Number							
TOC Track Descriptor									
0		Reserved							
1		ADR				CONTROL			
2		First Track Number In Last Complete Session							
3		Reserved							
4	(MSB)	Start Address of First Track in Last Session							
...									
7									
	(LSB)								

The TOC Data Length specifies the length in bytes of the available session data. The TOC Data Length value does not include the TOC Data Length field itself. This value is not modified when the allocation length is insufficient to return all of the session data available.

The First Complete Session Number is set to one.

The Last Complete Session Number indicates the number of the last complete session on the disc. The Last Complete Session Number shall be set to one for a single session disc or if the Logical Unit does not support multi-session discs.

The ADR field (Table 428) gives the type of information encoded in the Q Sub-channel of the block where this TOC entry was found.

The Control Field (Table 428) indicates the attributes of the track. First Track Number In Last Complete Session returns the first track number in the last complete session.

The Track Start Address contains the address of the first block with user information for the first track of the last session, as read from the Table of Contents.

6.30.3.3.2 MRW Deviations

If the disc is MRW formatted or in progress with MRW formatting, form 1 of the TOC shall report one session with one track. The track starting address shall be reported as shown in Table 439.

6.30.3.3.3 DVD-ROM, DVD-RAM, DVD+RW, DVD-R/-RW, and DVD+R

TOC form 1 data shall be fabricated according to Table 443

Table 443 – Fabrication of TOC Form 1 for Single Session DVD

Byte(s)	Field	Value
0, 1	TOC Data Length	000Ah
2	Number of First Complete Session	01h
3	Number of Last Complete Session	01h
Track Descriptor		
4	Reserved	00h
5	ADR, CONTROL	17h: DVD+R and DVD+MRW 14h: all others
6	First Track Number in last complete session	01h
7	Reserved	00h
8...11	Track Start Address	LBA form = 000000h, TIME form = 00:00:02:00

6.30.3.4 Response Format 0010b: Raw TOC

6.30.3.4.1 General

None of the fields in the response data of Format 0010b are affected by the TIME bit in the CDB. The response data returned for Format 0010b is specified in Table 444.

Table 444 – READ TOC/PMA/ATIP response data (Format = 0010b)

Bit	7	6	5	4	3	2	1	0
Byte								
0	(MSB) TOC Data Length (LSB)							
1								
2	First Complete Session Number							
3	Last Complete Session Number							
TOC Track Descriptor(s)								
0	Session Number (Hex)							
1	ADR				CONTROL			
2	TNO							
3	POINT							
4	Min							
5	Sec							
6	Frame							
7	Zero							
	HOUR				PHOUR			
8	PMIN							
9	PSEC							
10	PFRAME							

Multiple TOC Track Descriptors may be returned, but only one of each entry is reported.

For Format field of 0010b, the Logical Unit shall return TOC data for Q Sub-channel modes 1 and 5 (except mode 5, point 1 through 40) in the Lead-in area.

The TOC Data Length specifies the length in bytes of the available TOC data. The TOC Data Length value does not include the TOC Data Length field itself. This value is not modified when the allocation length is insufficient to return all TOC data available.

The First Complete Session Number shall be set to one.

The Last Complete Session Number indicates the number of the last complete session on the disc. The Last Complete Session Number is set to one for a single session disc or if the Logical Unit does not support multi-session discs.

The ADR field (Table 428) gives the type of information encoded in the Q Sub-channel of the block where this TOC entry was found.

The Control Field (Table 429) indicates the attributes of the track.

The ZERO field shall contain a value of zero for CD media other than DDCD media. For DDCD media this field shall contain the value HOUR in bits 7-4 and PHOUR in bits 3-0.

Entries in bytes 2 through 7 of the descriptors (TNO, POINT, MIN, SEC, FRAME, ZERO) shall be converted to binary by the Logical Unit when the media contains a value between 0 and 99bcd. For DDCD bytes 7 through 10 (PHOUR, PMIN, PSEC, and PFRAME) shall be converted to binary by the Logical Unit if the media contains a value between 0 and 99bcd. Otherwise, the value is returned with no modification.

The returned TOC data of a multi-session disc is arranged in ascending order of the session number with duplicates removed. The TOC data within a session is arranged in the order of Q Sub-channel

POINT field value of A0h – AFh, Track Numbers, B0h, BFh. Only recorded Points shall be returned.
The TOC Track Descriptor format in the Lead-in area of the TOC is described in Table 445.

Table 445 – TOC Track Descriptor Format, Q Sub-channel

CTRL	ADR	TNO	POINT	MIN	SEC	FRAME	ZERO	PMIN	PSEC	PFRAME
4 or 6	1	00h	01h-63h	ATIME (Absolute time)			00h	Start position of track		
4 or 6	1	00h	A0h	ATIME (Absolute time)			00h	First Track Number	Disc Type	00h
4 or 6	1	00h	A1h	ATIME (Absolute time)			00h	Last Track Number	00h	00h
4 or 6	1	00h	A2h	ATIME (Absolute time)			00h	Start position of Lead-out		
4 or 6	5	00h	B0h	Start time of next possible program in the Recordable Area of the disc			# of pointers in Mode 5	Maximum start time of outer-most Lead-out area in the Recordable Area of the disc		
4 or 6	5	00h	B1h	00h	00h	00h	00h	# of skip interval Pointers (N<=40)	# of skip Track Pointers (N<=21)	00h
4 or 6	5	00h	B2h-B4h	Skip #	Skip #	Skip #	Skip #	Skip #	Skip #	Skip #
4 or 6	5	00h	01h-40h	Ending time for the interval that should be skipped			Reserved	Start time for interval that should be skipped on playback		
4 or 6	5	00h	C0h	optimum recording power	Reserved	Reserved	Reserved	Start time of the first Lead-in Area of the disc		
4 or 6	5	00h	C1h	Copy of information from A1 point in ATIP.						

If the disc is MRW formatted or in progress with MRW formatting, form 2 of the TOC shall be constructed to contain the values expected when formatting has completed.

The DDCD TOC Track Descriptor format in the Lead-in area of the TOC is described in Table 446.

All of the TOC Track Descriptors (Table 445) are further define in sub-clause found.

Table 446 – DDCD TOC Track Descriptor Format, Q Sub-channel

CTRL	ADR	TNO	POINT	MIN	SEC	FRAME	HOUR	PHOUR	PMIN	PSEC	PFRAME
4	1	00h	01h-63h	ATIME (Absolute time)			Start position of track				
4	1	00h	A0h	ATIME (Absolute time)			0000b	First Track Number	Disc Type 20h	00h	
4	1	00h	A1h	ATIME (Absolute time)			0000b	Last Track Number	00h	00h	
4	1	00h	A2h	ATIME (Absolute time)			Start position of Lead-out				
4	1	00h	F0h	ATIME (Absolute time)			0000b	Book type Book ver.	Material type	Moment of inertia	
4	5	00h	B0h	Start time of next possible program in the Recordable / ReWritable Area of the disc			Maximum start time of outer-most Lead-out area in the Recordable / ReWritable Area of the disc				
4	5	00h	C0h	Copy of Special Information1 in ATIP (ROM: reserved and set to zero)			# of Mode 5 ptrs	Start time of the first Lead-in Area of the disc			
4	5	00h	C1h	Copy of Additional Information1 in ATIP.			0000b	Set to zero			
4	5	00h	CFh	Stop position of Inner part Lead-out Area			Start position of outer part Lead-in Area				

The POINT field (Table 447) defined various types of information within the lead-in TOC area.

Table 447 – POINT Field

ADR	POINT Field	Description
1	01-63h	Track number references
1	A0h	First Track number in the program area
1	A1h	Last Track number in the program area
1	A2h	Start location of the Lead-out area
5	01-40h	Skip Interval Pointers
5	B0h	Used to Identify a Multi-session Disc (Photo CD) Contains start time of next possible program area
5	B1h	Number of skip interval pointers & Skip track assignments
5	01-40h	Skip Interval Pointers
5	B2-B4h	Skip Track Assignment Pointers
5	C0h	Start time of first Lead-in area of disc (This only exists in the first Lead-in area)
5	C1h	Copy of information from additional area 1 in ATIP.

The Disc Type field (see Table 448) indicates the type of disc inserted.

Table 448 – Disc Type Byte Format

Value	Description
00h	CD-DA or CD Data with first track in Mode 1
10h	CD-I disc
20h	CD data XA disc with first track in Mode 2, DDCD disc

6.30.3.4.2 CD-MRW Deviations

If the disc is MRW formatted or in progress with MRW formatting form 2 of the TOC, PMA, shall be constructed to contain the values expected when formatting has completed.

6.30.3.4.3 DVD-ROM, DVD-RAM, DVD+RW, DVD+R, and DVD-R/-RW

No fabrication for DVD media is defined for form 0010b.

6.30.3.5 Response Format 0011b: PMA

6.30.3.5.1 General

None of the fields in the response data of Format 0011b are affected by the TIME bit in the CDB. The response data returned for Format 0011b is specified in Table 449.

Table 449 – READ TOC/PMA/ATIP response data (Format = 0011b)

Byte	Bit	7	6	5	4	3	2	1	0
0	(MSB)	PMA Data Length							
1		(LSB)							
2		Reserved							
3		Reserved							
PMA Descriptor(s)									
0		Reserved							
1		ADR				CONTROL			
2		TNO							
3		POINT							
4		Min							
5		Sec							
6		Frame							
7		Zero							
		HOUR				PHOUR			
8		PMIN							
9		PSEC							
10		PFRAME							

Multiple PMA Descriptors may be returned.

The returned PMA descriptors are arranged in the order found in the PMA, with duplicates removed.

The PMA Data Length indicates the length in bytes of the available PMA data. The PMA Data Length value does not include the PMA Data Length field itself. This value is not modified when the allocation length is insufficient to return all PMA data available. This value is set to 2 plus eleven times the number of descriptors read.

The ZERO field shall contain a value of zero for CD media other than DDCD media. For DDCD media this field shall contain the value HOUR in bits 7-4 and PHOUR in bits 3-0.

Entries in bytes 2 through 10 of the descriptors, (TNO, POINT, MIN, SEC, FRAME, Zero), shall be converted to binary by the Logical Unit if the media contains a value between 0 and 99bcd. (See 4.2.4.10.3)

6.30.3.5.2 CD-MRW Deviations

If the disc is MRW formatted or in progress with MRW formatting form 3 of the TOC, the PMA, shall be constructed to contain the values expected when formatting has completed.

6.30.3.5.3 DVD-ROM, DVD-RAM, DVD+RW, DVD+R, and DVD-R/-RW

No fabrication for DVD media is defined for TOC form 0011b.

6.30.3.6 Response Format 0100b: ATIP**6.30.3.6.1 General**

The TIME bit in the CDB affects no fields in the response data of Format 0100b. The response data returned for Format 0100b is specified in Table 450.

Table 450 – READ TOC/PMA/ATIP response data (Format = 0100b)

Byte	Bit	7	6	5	4	3	2	1	0	
0	(MSB)	ATIP Data Length								
1		(LSB)								
2		Reserved								
3		Reserved								
ATIP Descriptor										
Special Information 1										
0		Indicative Target Writing Power				(DDCD)	Reference Speed			
1	0	URU	Reserved							
2	1	Disc Type	Disc Sub-Type			A1 Valid	A2 Valid	A3 Valid		
3		Reserved								
Special Information 2										
4		ATIP Start Time of Lead-in (Min)								
5		ATIP Start Time of Lead-in (Sec)								
6		ATIP Start Time of Lead-in (Frame)								
7		Reserved								
Special Information 3										
8		ATIP Last Possible Start Time of Lead-out (Min)								
9		ATIP Last Possible Start Time of Lead-out (Sec)								
10		ATIP Last Possible Start Time of Lead-out (Frame)								
11		Reserved								
Additional Information 1										
12 – 14		A1 Values								
15		Reserved								
Additional Information 2										
16-18		A2 Values								
19		Reserved								
Additional Information 3										
20-22		A3 Values								
23		RESERVED								
24-26		S4 Values								
27		Reserved								

ATIP Data Length specifies the number of bytes to be transferred in response to the command. The ATIP Data Length value does not include the data length field itself. This value is not modified when the Allocation Length is insufficient to return all of the ATIP data available.

ATIP Descriptor field definition is dependent upon the setting of the DDCCD bit. When the DDCCD bit is set to zero, the fields are defined for CD-R/RW media. When the DDCCD bit is set to one, the fields are defined for DDCCD-R/RW media.

6.30.3.6.2 ATIP Descriptor for CD-R/RW Media

6.30.3.6.2.1 General

For specific field values and meanings, see *System Description Recordable Compact Disc Systems, part II and part III*.

6.30.3.6.2.2 Special Information 1

Indicative Device Writing Power is encoded information indicating the media's recommended initial laser power setting.

Reference Speed – is encoded information indicating the recommended write speed for the media.

The Unrestricted Use Disc (URU) bit is derived from Application Code. When Application Code indicates that the mounted disc is either for unrestricted use or general purpose, the Unrestricted Use bit is set to one. When the URU flag is zero, the mounted disc is defined for restricted use. In order to record data to the mounted disc the appropriate Initiator Application code shall be set through the Write Parameters Mode Page.

When Disc Type is zero, the media is CD-R. When Disc Type is one, the media is CD-RW.

Disc Sub-Type specifies one of 8 possible CD-RW sub-types of the Disc Type. CD-R has no sub-types, so this field is zeros. The sub-type typically identifies media sensitivity. When the media is made for higher speed applications, the media is more sensitive. Some higher speed write sub-type media may be damaged if recorded at power levels used for lower speed sub-types. The CD-RW Media Write Support Feature (5.3.29) identifies the Logical Unit's write support for all CD-RW sub-types.

A1 – when set to one, indicates that the A1 Values field is valid. Otherwise, the A1 Values field is invalid.

A2 – when set to one, indicates that the A2 Values field is valid. Otherwise, the A2 Values field is invalid.

A3 – when set to one, indicates that the A3 Values field is valid. Otherwise, the A3 Values field is invalid.

6.30.3.6.2.3 Special Information 2: Start Time of Lead-in

The Start Time of the Lead-in identifies the ATIP time of where the disc lead-in starts.

6.30.3.6.2.4 Special Information 3: Last Possible Start Time of Lead-out

For all CD-RW and CD-R conforming to Orange Book part II, Special Information 3 contains the MSF address of the maximum start point for the final lead-out. The Last Possible Start Time of Lead-out shall not be greater than 79:59:74 MSF. It is recommended that this boundary not be violated by extending the program area past the Last Possible Start Time of Lead-out.

A single session disc requires a final lead-out of 90 seconds, while a multi-session disc requires a final lead-out of 30 seconds. This suggests that the program area may violate the Last Possible Start Time of Lead-out by as much as 60 seconds when the disc is multi-session.

6.30.3.6.2.5 Special Information 3: Start Time of Additional Capacity

High capacity CD-R (See *High Capacity Recordable Disc Systems, Version 0.90, September 2002*) defines Special Information 3 as the Start Time for Additional Capacity. The additional capacity includes space for additional program area and the final lead-out. A field in Additional Information 1 defines the additional number of minutes. Thus:

Start Time of Additional Capacity as a PSN +

Capacity Extension as a number of sectors – 1 =

PSN of Last possible lead-out sector.

6.30.3.6.2.6 Additional Information 1

Additional Information 1 contains fields identify additional write strategy recording parameters.

For High capacity CD-R, Additional Information 1 also contains a Capacity Extension field. This field is coded for an extension in minutes. See 6.30.3.6.2.5, above.

6.30.3.6.3 ATIP Descriptor for DDCD-R/RW Media

Indicative Device Writing Power – encoded information indicating the media's recommended initial laser power setting. Unlike the CD version, the field is contained within the entire field.

Reference Speed – is encoded information indicating the recommended write speed for the media:

000b-001b = reserved, 010b = 4x recording, 011b = 8x recording, and 100b-111b is reserved.

The Unrestricted Use Disc (URU) bit is unchanged when used with DDCD media.

An Initiator Application Code

Disc Type – zero indicates DDCD-R media; one indicates DDCD-RW media.

Disc Sub-Type – has no meaning for DDCD and is reserved

A1, A2, and A3 are unchanged when used with DDCD media.

ATIP Start time of Lead-in – the start time of the lead-in. The value is binary and not in the HMSF format.

ATIP Last Possible Start Time of Lead-out – the last possible start time of lead-out. The value is binary and not in the HMSF format.

The special information 4 (S4) fields are available for both DDCD-R and DDCD-RW.

6.30.3.6.4 TOC/PMA/ATIP Format 0100b for DVD Media

TOC/PMA/ATIP format 0100b has no definition for data fabrication for DVD media. If the Initiator requests a TOC/PMA/ATIP of this form. The Logical Unit shall terminate the command with CHECK CONDITION status and set sense bytes SK/ASC/ASCQ to ILLEGAL REQUEST/INVALID FIELD IN CDB.

6.30.3.7 Response Format 0101b: CD-TEXT

None of the fields in the response data of Format 0101b (Table 451) are affected by the TIME bit in the CDB.

When a Read TOC/PMA/ATIP command with the Format code 0101b is presented for a DD CD-R/RW media, this command shall be rejected with an INVALID FIELD IN CDB.

Table 451 – READ TOC/PMA/ATIP response data (With Format Field = 0101b)

Byte	Bit	7	6	5	4	3	2	1	0
0	(MSB)	CD-TEXT Data Length							
1									
2	Reserved								
3	Reserved								
CD-TEXT Descriptor(s)									
0	CD-TEXT Data								
:									
17									

CD-TEXT Data Length specifies the number of bytes to be transferred in response to the command. The CD-TEXT Data Length value does not include the data length field itself. This value is not modified when the allocation length is insufficient to return all of the CD-TEXT data available. This length is variable depends on the number of recording Pack Data.

CD-TEXT Information Descriptor(s) provides Pack Data available in the lead-in area of the disc. Each Pack Data consists of 18 bytes of CD-TEXT information. If a Pack Data is recorded repeatedly on the disc, the device should return it only once.

The detail of Pack Data and CD-TEXT information is described in System Description Compact Disc Digital Audio Addendum: CD-TEXT.

TOC/PMA/ATIP format 0101b has no definition for data fabrication for DVD media. If the Initiator requests a TOC/PMA/ATIP of this form. The Logical Unit shall terminate the command with CHECK CONDITION status and set sense bytes SK/ASC/ASCQ to ILLEGAL REQUEST/INVALID FIELD IN CDB.

6.30.4 Timeouts

The READ TOC/PMA/ATIP command belongs to timeout group 1. If the command is terminated with CHECK CONDITION status due to a timeout, sense bytes SK/ASC/ASCQ shall be set to UNIT ATTENTION/INSUFFICIENT TIME FOR OPERATION.

6.30.5 Error Reporting

Recommended error reporting for the READ TOC/PMA/ATIP command is defined in Table 452.

Table 452 – Recommended errors for READ TOC/PMA/ATIP Command

Error	Reference
Unit Attention conditions	Table F.1
CDB or parameter list validation errors	Table F.2
Readiness errors	Table F.3
General media access errors	Table F.5
Read errors	Table F.6
Hardware failures	Table F.8

6.31 READ TRACK INFORMATION Command

6.31.1 Introduction

The READ TRACK INFORMATION Command provides information about a logical track. Logical track is a generic term used to reference logical subdivisions of an optical media. Logical track refers to track on CD media, Rzone on DVD-R/-RW media and fragment on DVD+R media. When the currently mounted media has no logical track structure, the entire media shall be considered a single logical track.

Table 453 shows the Features associated with the READ TRACK INFORMATION command.

Table 453 – Features Associated with the READ TRACK INFORMATION Command

Feature Number	Feature Name	Command Requirement
001Dh	Multi-Read	Mandatory
0021h	Incremental Streaming Writable	Mandatory
0026h	Restricted Overwrite	Mandatory
0027h	CD-RW CAV Write	Mandatory
002Bh	DVD+R	Mandatory
002Ch	Rigid Restricted Overwrite	Mandatory
002Dh	CD Track At Once	Mandatory
002Eh	CD Mastering (both SAO and RAW)	Mandatory
002Fh	DVD-R/-RW Write	Mandatory
0031h	DDCD-R Write	Mandatory
0032h	DDCD-RW Write	Mandatory

6.31.2 The CDB and Its Parameters

6.31.2.1 The CDB

The READ TRACK INFORMATION CDB is shown in Table 454.

Table 454 – READ TRACK INFORMATION CDB

Byte	Bit	7	6	5	4	3	2	1	0	
0		Operation Code (52h)								
1		Reserved						Address/Number Type		
2	(MSB)	Logical Block Address/ Track/Session Number								
3										
4										
5	(LSB)									
6		Reserved								
7	(MSB)	Allocation Length								
8		(LSB)								
9		Control Byte								

6.31.2.2 Address/Number Type

The Address/Number Type field in byte 1 is used to specify the contents of the Logical Block Address/Track/Session Number field, bytes 2 through 5 of the CDB. The Description of these parameters is shown in Table 455.

6.31.2.3 Logical BlockAddress/Track/Session Number Fields

The Logical Block Address/Track/Session Number field either directly or indirectly specifies the logical track for which the Logical Unit is to provide track information. See Table 455.

Table 455 – LBA/Track/Session Number Field definition

Address/ Number Type field	Logical Block Address/Track/Session Number	Description
00b	Logical Block Address	The LBA shall reference a sector in the current LBA Space as defined by the READ CAPACITY command response. The primary physical sector represented by this LBA lies within some logical track, T. The information for T shall be collected, formatted, and returned by the Logical Unit. If the LBA is not within the current LBA Space, the command shall be terminated with CHECK CONDITION status and sense bytes SK/ASC/ASCQ shall be set to ILLEGAL REQUEST/LOGICAL BLOCK ADDRESS OUT OF RANGE.
01b	00h	Information shall be collected for the disc Lead-in area as if it is a logical track.
01b	Logical track number	Information shall be collected for the logical track specified. If the logical track number is not valid, the command shall be terminated with CHECK CONDITION status and sense bytes SK/ASC/ASCQ shall be set to ILLEGAL REQUEST/INVALID FIELD IN CDB.
01b	FFh	T _{INV} , where T _{INV} is the Track number of the invisible or incomplete Track
10b	Session Number	T _{Session} where T _{Session} is the track number of the first logical track in Session
11b	Reserved	

6.31.2.4 Allocation Length

The number of Track Information Block bytes returned is limited by the Allocation Length parameter of the CDB. An Allocation Length of zero is not an error.

6.31.3 Command Execution

6.31.3.1 Overview

The Logical Unit shall collect the information requested by the Initiator into a Track Information Block structure, and transfer to the Initiator, restricted by Allocation Length.

The READ TRACK INFORMATION command shall provide minimal information for a disc with Unrecordable status: Track Number, Session Number, Track Mode, Data Mode, Track Start Address.

The format and content of the Track Information Block is shown in Table 456.

Table 456 – Track Information Block

Byte	Bit	7	6	5	4	3	2	1	0
0	(MSB)	Data Length							
1		(LSB)							
2		Track Number (Least Significant Byte)							
3		Session Number (Least Significant Byte)							
4		Reserved							
5		Reserved		Damage	Copy	Track Mode			
6		RT	Blank	Packet/Inc	FP	Data Mode			
7		Reserved						LRA_V	NWA_V
8	(MSB)	Track Start Address							
9									
10									
11		(LSB)							
12	(MSB)	Next Writable Address							
13									
14									
15		(LSB)							
16	(MSB)	Free Blocks							
17									
18									
19		(LSB)							
20	(MSB)	Fixed Packet Size/ Blocking Factor							
21									
22									
23		(LSB)							
24	(MSB)	Track Size							
25									
26									
27		(LSB)							
28	(MSB)	Last Recorded Address							
29									
30									
31		(LSB)							
32		Track Number (Most Significant Byte)							
33		Session Number (Most Significant Byte)							
34		Reserved							
35		Reserved							
36	(MSB)	Read Compatibility LBA							
...									
39		(LSB)							

6.31.3.2 Data Length

The Data Length field specifies the length, in bytes, of the available track information data. The Data Length value does not include the data length field itself. The Data Length is not modified when the allocation length is insufficient to return all of the response data available.

6.31.3.3 Track Number

Track Number is contained within bytes 2 and 32 of this structure. For media not containing logical

tracks (track, Rzone, or Fragment), this field shall contain the value 1.

If the Track number is set to zero, and the P through W bit is set (see Table 600), the contents of Track Information Block shall be returned for the lead-in area. In this case, the Track Start Address field is the start address of the lead-in area.

6.31.3.4 Session Number

Session Number is the number of the session containing this track, or a value of 1 for media not containing sessions that contain this track.

6.31.3.5 Copy bit

The Copy bit indicates that this track is a second or higher generation copy. For media that does not support CGMS, this bit shall be set to zero.

6.31.3.6 Damage Bit

The Damage bit, when set to one, and the NWA_V is set to zero; the track shall be considered “not closed due to an incomplete write”. The Logical Unit may attempt an automatic repair when the CLOSE TRACK/SESSION command is issued. Further incremental writing in this track is not possible. The Damage bit, when set to one, and the NWA_V is set to one, indicates a Track that may be recorded further in an incremental manner. The Logical Unit shall attempt an automatic repair when the next command that requires writing to the Track is issued. If the repair is successful, the Damage bit shall be set to zero. Prior to the start of the repair, the NWA field shall contain the address of the Next Writable Sector assuming a successful repair.

6.31.3.7 Track Mode

Track mode was originally defined for CD media and is recorded on the media. This method of determining track mode has been extended to DDCD. For other media, track mode is fabricated from the media characteristics.

Table 457 – Track Mode Definition

Media/Format	Track Mode
CD-ROM/-R/-RW	Track Mode for CD and DDCD is the control nibble as defined for mode 1 Q Sub-channel for this track. See Table 596 and Table 429.
DDCD-ROM/-R/-RW	
DVD+MRW, DVD+R	07h, indicating: data, incremental recording, copy permitted
All other media	04h, indicating: data, uninterrupted recording, no copy permissions

6.31.3.8 Track Status: RT, Blank, Packet, and FP Bits

The meaning of the RT (Reserved Track) bit is defined in Table 458.

Table 458 – RT Bit Definition

Media Type	RT = 0	RT = 1
CD and DDCD	The Track is the invisible track	A PMA entry is written identifying the start and end addresses of the track
DVD-R/-RW	The Rzone is Complete, Invisible or Incomplete	The Rzone is reserved. It may be either empty or partially recorded.
DVD-RAM	Default	—
DVD+RW	Default	—
DVD+R	The Logical Track is the invisible fragment.	The bounds of the fragment are defined within the Disc/Session Identification Zone.

The definition of the Blank bit is given in Table 459.

Table 459 – Blank Bit Definition

Media Type	Blank = 0	Blank = 1
CD and DDCD	Minimally, the track pre-gap is written.	All sectors within the track and its pre-gap are blank.
DVD-R/-RW	Some non-zero number of ECC blocks within the Rzone is written.	All ECC blocks within the Rzone are blank.
DVD-RAM	Blank has no meaning for DVD-RAM media. The Blank bit shall always be zero (0) for DVD-RAM media.	
DVD+RW	The Disc Status in the Disc Information Block shows that the disc is not blank.	The Disc Status in the Disc Information Block shows that the entire disc is blank.
DVD+R	Some non-zero number of ECC blocks within the Fragment is written.	All ECC blocks within the Fragment are blank.

The definition of the Packet/Inc bit is given in Table 460.

Table 460 – Packet/Inc Bit Definition

Media Type	Packet/Inc = 0	Packet/Inc = 1
CD and DDCD	Based upon existing track format and Write Parameters Mode Page	
DVD-R/-RW	Based upon existing Rzone format and Write Parameters Mode Page	
DVD-RAM	—	Always
DVD+RW	—	Always
DVD+R	—	Always

The definition of the FP (Fixed Packet) bit is given in Table 461.

Table 461 – FP bit Definition

Media Type	FP = 0	FP = 1
CD and DDCD	Based upon existing track format and Write Parameters Mode Page	
DVD-R/-RW	Based upon existing Rzone format and Write Parameters Mode Page	
DVD-RAM	—	Always
DVD+RW	—	Always
DVD+R	—	Always

When writing CD and DVD-R/-RW, certain parameters may be set via the Write Parameters Page. The state of the track determines what parameters shall be set and that parameters in the mode page shall match. Required Write Parameters are defined in Table 462.

Table 462 – Write Parameter Restrictions due to Track State

RT	Blank	Packet	CD Write Parameter Restrictions	DVD-R/-RW Write Parameter Restrictions
0	0	0	Unable to write to stamped disc, or during track at once on invisible track, or writing session at once mode	Unable to write to stamped disc, or writing disc-at-once, unable to write to complete disc.
0	0	1	Write type is set to packet; all parameters common to READ TRACK I and the Write Parameters Page shall match.	Write type is set to incremental; all parameters common to READ TRACK I and the Write Parameters Page shall match
0	1	0	Write type may be set to packet or TAO. All other parameters shall be changeable. If this track is the first track of a Session, then Session at Once is allowed.	Write type is set to disc-at-once: Invisible Track of disc-at-once, empty. Unable to start disc-at-once recording in this state. A Track shall be reserved prior to start of disc-at-once recording. All parameters common to READ TRACK I and the Write Parameters Page shall match
0	1	1	Invalid State	Write type is set to incremental; Invisible track for incremental recording, the Track is writable. All parameters common to READ TRACK I and the Write Parameters Page shall match
1	0	0	Unable to write to recorded track or during track at once on reserved Track.	Unable to write to disc during disc at once on reserved Track.
1	0	1	Write type is set to packet; all parameters common to READ TRACK INFO and the Write Parameters Page shall match.	Write type is set to incremental; Partially recorded reserved Track, the Track is writable. All parameters common to READ TRACK I and the Write Parameters Page shall match
1	1	0	Write type is set to TAO. Track mode set to same as READ TRACK INFO. Copy bit may be set only if copyright bit in track mode is clear. All other common parameters shall match.	Write type is set to disc-at-once; Empty reserved Track for disc-at-once. All parameters common to READ TRACK I and the Write Parameters Page shall match
1	1	1	Write type is set to Packet. Track mode set to same as READ TRACK INFO. Copy bit may be set only if copyright bit in track mode is clear. FP and packet size are changeable. All other common parameters shall match.	Write type is set to incremental; Empty reserved Track, the Track is writable. All parameters common to READ TRACK I and the Write Parameters Page shall match

Table 463 shows the consequences of the Logical Track status bits: RT, Blank, Packet/Inc, and FP.

Table 463 – Track Status Indications

RT	Blank	Packet/ Inc	FP	DVD-R/-RW		CD	
				Write Method	Track Status	Write Method	Track Status
0	0	0	-	- DAO	Complete	Uninterrupted/ TAO/SAO	Complete/During TAO/SAO
0	0	1	0	Incremental	Incomplete or Complete ¹	Variable	Incomplete
0	0	1	1	- Restricted Overwrite	Complete or Incomplete ²	Fixed	Incomplete
0	1	0	-	DAO	Invisible	TAO/Variable/ Fixed ³	Invisible
0	1	1	0	Incremental	Invisible	-	(invalid)
0	1	1	1	- Restricted Overwrite	Invisible	-	(invalid)
1	0	0	-	DAO	during DAO	TAO	Complete/During TAO
1	0	1	0	Incremental	Partially Recorded Reserved	Variable	Complete/ Partially Recorded Reserve
1	0	1	1	-	(invalid)	Fixed	Complete/ Partially Recorded Reserve
1	1	0	-	DAO	Empty Reserved Before starting writing	TAO	Empty Reserved
1	1	1	0	Incremental	Empty Reserved	Variable/Fixed	Empty Reserved
1	1	1	1	-	(invalid)	-	(invalid)

¹ If Free Blocks field is 0, the track is in the Complete state. Otherwise, the track is Incomplete state.
² In the case of a track that is in the intermediate state session, the track is considered as in the Incomplete state.
³ In case last Session is empty, SAO is also valid.

6.31.3.9 Data Mode

Data Mode field defines the track content. Data Mode is defined in Table 464.

Table 464 – Data Mode

Value	Definition
1	Mode 1 (ISO/IEC 10149)
2	Mode 2 (ISO/IEC 10149 or CD-ROM XA) DDCD
Fh	Data Block Type unknown (no track descriptor block)
0, 3 – Eh	Reserved

6.31.3.10 NWA_V

If NWA_V is zero, then the next writable address field is not valid. Otherwise the next writable address field is valid. NWA_V shall be set to zero if the Track is not writable for any reason. If the disc is MRW formatted or in progress with MRW formatting, then NWA_V shall be set to zero.

6.31.3.11 LRA_V

If LRA_V is zero, then the Last Recorded Address field is not valid. Otherwise, the Last Recorded Address field is valid. The LRA_V bit shall be set to zero if the Track has damage for any reason and is repaired automatically.

6.31.3.12 Track Start Address

Track Start Address contains the address of the first block with user information for that track.

6.31.3.13 Next Writable Address

The Next Writable Address, if valid, is the LBA of the next writable user block in the Track specified by the LBA/Track Number field in the CDB. For CD media, Next Writable Address shall be associated with the RT, Blank, Packet and FP bits as defined in Table 465. If the write type is Raw, the Next Writable Address may be a negative number as required to point to the start of the first Lead-in. When streaming in any write type, the Next Writable Address shall be the next user data block the Logical Unit expects to receive if no under-run occurs.

Table 465 – Next Writable Address Definition

RT	Blank	Packet	FP	NWA_V	Definition
0	0	0	-	0 ⁴	LBA that shall be specified by next write command ²
0	0	1	0	1 ¹	LBA that shall be specified by next write command ²
0	0	1	1	1 ¹	LBA that shall be specified by next write command ^{2,3}
0	1	0	0	1	LBA of the first data block after pre-gap ⁵
0	1	1	0	-	-
0	1	1	1	-	-
1	0	0	-	0 ⁴	LBA that shall be specified by next write command ²
1	0	1	0	1 ¹	LBA that shall be specified by next write command ²
1	0	1	1	1 ¹	LBA that shall be specified by next write command ^{2,3}
1	1	0	-	1	LBA of the first data block after pre-gap
1	1	1	0	1	LBA of the first data block after pre-gap
1	1	1	1	-	-

¹When "Free Blocks" is 0 (data full), NWA_V is 0.

²The NWA takes account of data blocks in buffer that have not yet been written to media. If the Logical Unit is able to write the data of next write command without interrupting of current data streaming (no underrun condition), the NWA is contiguous to the last address data in buffer. If WCE in Mode Cache Page is zero, the NWA takes account of Link Blocks (2 Run-out blocks, 1 Link block and 4 Run-out blocks) in case of Addressing Method-1.

³NWA calculations follow the Addressing Method-2.

⁴During TAO (SAO), NWA_V is 1.

⁵In the case of SAO the NWA is the first block after the Lead-in for the first track of session.

6.31.3.14 Free Blocks

The Free Blocks field represents the maximum number of user data blocks available for recording in the track. If the medium is MRW formatted or in progress with MRW formatting, Free Blocks shall be set to zero. For CD media, this field shall be computed as follows: First, the Available Track Space (ATS) shall be computed. In the cases that follow *StartTimeofLastPossibleLead-out* is as defined in 6.26.3.18.

For the invisible track, $ATS = (StartTimeofLastPossibleLead-out) - NWA + 5$.

For a reserved track, $ATS = (PMASopTime) - NWA + 5$.

For DDCD media, this field shall be computed as follows: First, the Available Track Space (ATS) shall be computed.

For the invisible/incomplete track, $ATS = (StartTimeofLastPossibleLead-out) - NWA + 4$.

For a reserved track, $ATS = (PMASopTime) - NWA + 4$.

If the track is reserved for fixed packets, or written with fixed packets, or is the invisible track and the Write Parameters Page specifies fixed packets,

$$FreeBlocks = IP \left[\frac{ATS}{PacketSize + 7} \right] \cdot PacketSize.$$

Otherwise, $FreeBlocks = ATS - 7$.

The *StartTimeofLastPossibleLead-out* is the last possible location of the link block at the start of the Lead-out. If a disc is fully recorded, the PMA entry for the last track is equal to the *StartTimeofLastPossibleLead-out*.

The Logical Unit for reading and writing translates addressing within fixed packet written tracks. The NWA shall also reflect this translation:

$$NWA_{Method2} = NWA_{Method1} - 7 \cdot IP \left[\frac{NWA_{Method1} - TrackStartAddress}{PacketSize + 7} \right]$$

Method 1 is the physical address.

Method 2 is used on fixed packet written tracks to hide the link areas from the Initiator. The *TrackStartAddress* is always a physical address, even if prior tracks are recorded with Method 2. $IP[...]$ is the integer part of the value.

6.31.3.15 Fixed Packet Size

For CD, the Fixed Packet Size is valid only when the Packet and the FP bits are both set to one. For DVD-R, if the FP bit is set to zero, the Fixed Packet Size field specifies the number of sectors that are actual disc access unit. In the case of DVD, this field has a value of 16. FP bit set to one is undefined.

If the disc is stamped, then $DAMAGE = 0$, $BLANK = 0$, $RT = 0$, and $NWA_V = 0$.

6.31.3.16 Track Size

6.31.3.16.1 General

Track Size is the number of user data blocks in the logical track.

6.31.3.16.2 CD and DDCD Track Size

For CD the track size shall be computed as follows:

First, compute the Complete Track Size (CTS).

For an incomplete track: $CTS = (StartTimeofLastPossibleLead-out) - PMATrackStart + 5$.

For a reserved track: $CTS = (PMASopTime) - PMAStartTime + 5$.

For DDCD, the track size shall be computed as follows:

For an incomplete DD CD track:

$$CTS = (StartTimeofLastPossibleLead-out) - PMATrackStart + 4.$$

For a reserved DD CD track:

$$CTS = (PMAStopTime) - PMAStartTime + 4.$$

If the track is reserved for, or written with, fixed packets: $TrackSize = IP \left[\frac{CTS}{PacketSize + 7} \right] \bullet PacketSize.$

Otherwise, $TrackSize = CTS - 7.$

For CD media, the Track Size number may not be exact for the tracks that do not have a PMA entry. The track size, of tracks that do not have PMA entries, is calculated as follows:

TrackSize of track $n = (start\ of\ track\ n+1) - (start\ of\ track\ n)$, $n+1$ is the Lead Out if n is the last track recorded in the TOC.

The Track Size from this calculation may include blocks from the following track and these blocks may not be readable.

If the disc is MRW formatted or in progress with MRW formatting, Track Size shall be reported according to the LBA Space selected in the MRW Mode Page. The Track Size of a MRW disc is simply the sum of all the DA sizes given in user sectors.

6.31.3.16.3 DVD-ROM Track Size

A DVD-ROM disc has exactly one logical track, track 1. The logical track size is calculated using information collected from the Control Data Zone:

$$Logical\ Track\ Size = End\ Physical\ Sector\ Number\ of\ Data\ Area - Starting\ Physical\ Sector\ Number\ of\ Data\ Area + 1.$$

6.31.3.16.4 DVD-RAM Track Size

A DVD-RAM disc has exactly one logical track, track 1. The logical track size is calculated using information collected from the Control Data Zone:

$$Logical\ Track\ Size = End\ Physical\ Sector\ Number\ of\ Data\ Area - Starting\ Physical\ Sector\ Number\ of\ Data\ Area + 1.$$

6.31.3.16.5 DVD-R/-RW Track Size

For DVD-R/-RW, the Track Size field reports the number of sectors in the specified logical track (Rzone) as follows:

If the Rzone is complete, this field reports the number of sectors in the specified Rzone including all padded sectors except the last 1 or 16 sectors of the Rzone.

The Rzone size is calculated according to the following rule:

First, compute the following bit mask operation to get Linking Status of Rzone (LSR):

$$LSR = NextRZoneStartAddress \&\& 01h \text{ (" \&\&" means the logical AND operation)}$$

where the NextRZoneStartAddress is the start address of the Rzone that is located immediately after the complete Rzone to be calculated.

NOTE 23: If the complete Rzone to be calculated is the last Rzone, the NextRZoneStartAddress is the start address of the last Border-out.

If the $LSR = 0$,

$$RzoneSize = NextRZoneStartAddress - RzoneStartAddress - 16\ sectors;$$

Otherwise,

$$RzoneSize = NextRZoneStartAddress - RzoneStartAddress - 1\ sectors; \text{ where the } RzoneStartAddress \text{ is the start address of the complete Rzone to be calculated.}$$

For an incomplete Rzone or invisible Rzone, this field reports the number of sectors in the specified Rzone including unrecorded sectors except the sectors to be used for the Border-out or truncated Border-out and its BSGA (16 sectors). The end address of the invisible/incomplete Rzone is specified by the Outer limit of Data Recordable area field or the End PSN of Data Area field in Data Area Allocation field of Control Data Zone.

The Rzone size is calculated as follows:

$RzoneSize = EndPSNOfRZone - RzoneStartAddress - NumberOfSectorsInBorderOut - 16$ sectors, where the *EndPSNOfRZone* is the end address of the invisible/incomplete Rzone.

The *NumberOfSectorsInBorderOut* is the number of sectors to be recorded as Border-out or truncated Border-out just before the Lead-out.

For a reserved Rzone, this field reports the number of sectors in the specified Rzone including all unrecorded sectors except the last 16 sectors of the Rzone to be used as a BSGA.

The Rzone size is calculated as follows:

$RzoneSize = NextRZoneStartAddress - RzoneStartAddress - 16$ sectors

6.31.3.16.6 DVD+RW Track Size

A DVD+RW disc has exactly one logical track, track 1. The logical track size is calculated using information collected from the disc ADIP:

$Logical\ Track\ Size = End\ Physical\ Sector\ Number\ of\ Data\ Area - Starting\ Physical\ Sector\ Number\ of\ Data\ Area + 1.$

6.31.3.16.7 DVD+R Track Size

A DVD+R logical track may be either the collection of all fragments within a closed session or an individual fragment from the open session.

When the specified track is a collection of fragments in a closed session, the track size is calculated using information from the most recent TOC block from the TOC Zone. In this case, the track size is given by *Session end Address – Session Start Address + 1*.

If the specified track is a fragment within the open session, and the fragment is not the invisible fragment, then track size is calculated using information from the most recently written SDCB for the session. In this case track size is given by *Fragment Stop Address – Fragment Start Address + 1*.

If the specified track is the invisible fragment, then track size is calculated using information from the most recently written SDCB for the session and ADIP information. In this case track size is given by *Lead-out Zone Start Address – Fragment Start Address*.

6.31.3.17 Last Recorded Address

The Last Recorded Address is valid only for DVD-R/-RW. It is the address of last written user data sector of the specified Rzone. The last written sector of padded sectors shall not be considered as the last written user data sector.

6.31.3.18 Read Compatibility LBA

If the disc is DVD+R and the track is the invisible track (i.e., RT=0), the Read Compatibility LBA shall be present. Some read-only devices are constructed such that a minimal amount of a disc shall be recorded (typically to a radius of 28 – 30 mm) in order that it is acceptable as a valid, readable disc. The Read Compatibility LBA is a padding recommendation from the Logical Unit that the Initiator may use to ensure a minimal recorded radius.

6.31.4 Timeouts

The READ TRACK INFORMATION command belongs to timeout group 1. If the command is terminated with CHECK CONDITION status due to a timeout, sense bytes SK/ASC/ASCQ shall be set to UNIT ATTENTION/INSUFFICIENT TIME FOR OPERATION.

6.31.5 Error Reporting

Table 466 describes errors that may occur during the operation of the command or that may cause a CHECK CONDITION status to be reported.

Table 466 – Recommended Errors for the Read Track Information Command

Error	Reference
Unit Attention conditions	Table F.1
CDB or parameter list validation errors	Table F.2
Readiness errors	Table F.3
General media access errors	Table F.5
Read errors	Table F.6
Hardware failures	Table F.8

6.32 REPAIR TRACK Command

6.32.1 Introduction

A track that has been defined for incremental writing on DVD-R/-RW may be damaged due to an incomplete ECC block at the end of written data. This may be caused by a reset issued or a power-fail condition during a write operation. The REPAIR TRACK command shall fill multiple ECC block lengths with data from beginning of the damaged sector of the ECC block and ending with a link field. The recovery is intended only to allow the track to become writable again.

The REPAIR TRACK command is optional for all MM devices. The REPAIR TRACK command is not mandatory under any Feature defined in this standard.

6.32.2 The CDB and Its Parameters

6.32.2.1 The CDB

The REPAIR TRACK CDB is shown in Table 467.

Table 467 – REPAIR TRACK CDB

Byte	Bit	7	6	5	4	3	2	1	0
0		Operation Code (58h)							
1		Reserved							IMMED
2		Reserved							
3		Reserved							
4	(MSB)	Track Number							(LSB)
5									
6		Reserved							
7		Reserved							
8		Reserved							
9		Control							

6.32.2.2 IMMED

If IMMED is zero, the requested repair operation is processed to completion prior to returning status. If IMMED is set to one, status is returned once the CDB has been validated.

6.32.2.3 Track Number

The Track Number field specifies the track that requires repair.

6.32.3 Command Execution

If the Logical Unit is unable to write to the currently mounted medium, error reporting should follow the guidelines according to 4.1.6.3.

Behavior of this command is the same as automatic repair (see the DAMAGE bit description in 6.31.3.6). This command causes a repair action without an explicit write of data.

6.32.4 Timeouts

The REPAIR TRACK command belongs to timeout group 1. If the command is terminated with CHECK CONDITION status due to a timeout, sense bytes SK/ASC/ASCQ shall be set to UNIT ATTENTION/INSUFFICIENT TIME FOR OPERATION.

6.32.5 Error Reporting

Recommended error reporting for the REPAIR TRACK command is defined in Table 468.

Table 468 – Recommended errors for REPAIR TRACK Command

Error	Reference
Unit Attention conditions	Table F.1
CDB or parameter list validation errors	Table F.2
Readiness errors	Table F.3
Protocol errors	Table F.4
General media access errors	Table F.5
Write errors	Table F.7
Hardware failures	Table F.8

6.33 REPORT KEY Command

6.33.1 Introduction

The REPORT KEY command requests the start of the authentication process and provides data necessary for authentication and for generating a Bus Key for the DVD Logical Unit. This command, in conjunction with the SEND KEY command, is intended to perform authentication for Logical Units that conform to DVD Content Protection schemes, and generates a Bus Key as the result of that authentication.

The REPORT KEY command also requests the DVD Logical Unit to transfer TITLE KEY data, obfuscated by a Bus Key, to the Initiator.

Table 469 shows the Features associated with the REPORT KEY command.

Table 469 – Features Associated with the REPORT KEY Command

Feature Number	Feature Name	Command Requirement
0106h	DVD CSS	Mandatory
010Bh	DVD CPRM	Mandatory

6.33.2 The CDB and Its Parameters

6.33.2.1 The CDB

The REPORT KEY CDB is shown in Table 470.

Table 470 – REPORT KEY CDB

Bit	7	6	5	4	3	2	1	0
Byte								
0	Operation Code (A4h)							
1	Reserved			Reserved				
2	(MSB) Reserved/Logical Block Address (LSB)							
3								
4								
5								
6	Reserved							
7	Key Class							
8	(MSB) Allocation Length (LSB)							
9								
10	AGID			KEY Format				
11	Control							

6.33.2.2 Reserved/Logical Block Address

The Reserved/Logical Block Address field is dependent upon the Key Format value. See 6.33.2.6.

6.33.2.3 Key Class

The Key Class field shall identify the type of authentication conversation according to Table 471.

Table 471 – KEY Class Definition

Key Class	Authentication Type
00h	DVD CSS/CPM or CPRM
01h	ReWritable Security Service – A
02h – FFh	Reserved

NOTE 24: DVD CSS/CPM and CPRM authentication use the same Key Class field value

since they have the same Challenge KEY, KEY1, and KEY2 sizes, and since they are licensed through the same entity.

6.33.2.4 Allocation Length

The Allocation Length field specifies the maximum length in bytes of the REPORT KEY response data that shall be transferred from the Logical Unit to the Initiator. An Allocation Length of zero indicates that no data shall be transferred. This condition shall not be considered as an error.

6.33.2.5 AGID

The AGID field is used to control simultaneous key exchange sequences. The AGID specified in subsequent Key Exchange commands shall match a currently active AGID. An AGID becomes active by requesting one with KEY Format 000000b or 010001b. The AGID remains active until the authentication sequence completes or is invalidated. The AGID field shall be reserved when the KEY Format Field contains 0h, 5h or 11h.

NOTE 25: Logical Units that support more than one KEY Format for requesting an AGID do not necessarily support simultaneous key exchange sequences.

6.33.2.6 KEY Format

The KEY Format field (Table 472) indicates the types of information that is to be sent to the Initiator.

Table 472 – KEY Format Code definitions for REPORT KEY Command (KEY Class 0)

Key Format	Returned Data	Description	AGID Use
000000b	AGID for CSS/CPPM	Returns an AUTHENTICATION GRANT ID for Authentication for CSS/CPPM	Reserved & N/A
000001b	Challenge Key	Returns a Challenge KEY	Valid AGID Required
000010b	KEY1	Returns a KEY1	
000100b	TITLE KEY	Returns a TITLE KEY obfuscated by a Bus Key	
000101b	ASF	Returns the current state of the Authentication Success Flag for CSS/CPPM	Reserved & Ignored
001000b	RPC State	Report Logical Unit region settings	
010001b	AGID for CPRM	Returns an AUTHENTICATION GRANT ID for Authentication for CPRM	Reserved & N/A
111111b	None	Invalidate Specified AGID. Invalidating an invalid AGID shall not be considered an error. An AGID that has not been granted shall be considered invalid	Valid AGID required
All other values	Reserved		

6.33.3 Command Execution

6.33.3.1 Key Format = 000000b, AGID for CSS/CPM

This KEY Format requests the Logical Unit to return an Authentication Grant ID for CSS/CPM. If the authentication process is started by the REPORT KEY command with a KEY Format of 000000b, the authentication shall be processed to exchange Key data only for CSS/CPM protected contents.

NOTE 26: If the command with this KEY Format is required by an implemented Feature, the command should function, even when the current bit for that Feature is zero.

Table 473 defines the response data for Key Format 000000b.

Table 473 – REPORT KEY Data Format (With KEY Format = 000000b, Key Class = 0)

Byte	Bit	7	6	5	4	3	2	1	0
0	(MSB)	REPORT KEY Data Length (06h)							(LSB)
1									
2		Reserved							
3		Reserved							
AUTHENTICATION GRANT ID FOR CSS/CPM									
0		Reserved							
1		Reserved							
2		Reserved							
3		AGID	Reserved						

6.33.3.2 Key Format = 000001b, Challenge Key

Challenge Key Value field returns a value to be used to interrogate an external device to determine conformance with the DVD Content Protection scheme. The external device then generates the corresponding KEY2.

Table 474 defines the response data for Key Format 000001b

Table 474 – REPORT KEY Data Format (With KEY Format = 000001b, Key Class = 0)

Byte	Bit	7	6	5	4	3	2	1	0
0	(MSB)	REPORT KEY Data Length (0Eh)							(LSB)
1									
2		Reserved							
3		Reserved							
Challenge Key									
0	(MSB)	Challenge Key Value							(LSB)
:									
9									
10		Reserved							
11		Reserved							

6.33.3.3 Key Format = 000010b, KEY1

KEY1 Value field returns a value used to determine the Logical Unit's conformity with DVD Content Protection scheme by an external device. The KEY1 value is also used as a parameter to generate a Bus Key in the Logical Unit.

When the Logical Unit is unable to produce a KEY1 value, this command with KEY Format = 000010b shall be terminated with CHECK CONDITION status and SK/ASC/ASCQ shall be set to ILLEGAL REQUEST/COPY PROTECTION KEY EXCHANGE FAILURE – KEY NOT PRESENT.

Table 475 defines the response data for Key Format 000010b

Table 475 – REPORT KEY Data Format (With KEY Format = 000010b, Key Class = 0)

Bit	7	6	5	4	3	2	1	0	
Byte									
0	(MSB) REPORT KEY Data Length (0Ah)								
1									(LSB)
2	Reserved								
3	Reserved								
KEY1									
0	(MSB) KEY1 Value								
:									
4									(LSB)
5									Reserved
6	Reserved								
7	Reserved								

6.33.3.4 Key Format = 000100b, TITLE KEY

Table 476 defines the response data for Key Format 000100b.

Table 476 – REPORT KEY Data Format (With KEY Format = 000100b, Key Class = 0)

Bit	7	6	5	4	3	2	1	0
Byte								
0	(MSB) REPORT KEY Data Length (0Ah)							
1								
2	Reserved							
3	Reserved							
COPYRIGHT MANAGEMENT/TITLE KEY Information								
0	CPM	CP_SEC	CGMS		CP_MOD			
1	(MSB) TITLE KEY Value							
2								
3								
4								
5								
6	Reserved							
7	Reserved							

The CPM bit identifies the presence of copyrighted material in this sector. If set to zero the material is not copyrighted, if set to one the material is copyrighted.

When the CPM bit is one, the CP_SEC field indicates that the specified sector has a specific data

structure for copyright protection system. If set to zero no such data structure exists in this sector .If set to one, a specific data structure for CSS or CPPM exists in this sector.

When the CPM bit is 1, the CGMS field indicates the restrictions on copying:

- 00b Copying is permitted without restriction
- 01b Reserved
- 10b One generation of copies may be made
- 11b No copying is allowed

When the CP_SEC bit is 1, the CP_MOD field indicates the copyright protection mode of the specified sector. A value of 0h indicates the sector is scrambled by CSS. A value of 1h indicates the sector is encrypted by CPPM. Other values are reserved.

The Reserved/Logical Block Address field in the CDB specifies the logical block address that contains the TITLE KEY to be sent to the Initiator obfuscated by a Bus Key.

The length of Title Key Value is currently 5 bytes only. CPPM protected sectors do not contain a TITLE KEY.

When the TITLE KEY does not exist on the specified sector of DVD media, this command with KEY Format = 000100b shall be terminated with CHECK CONDITION status and SK/ASC/ASCQ shall be set to ILLEGAL REQUEST/COPY PROTECTION KEY EXCHANGE FAILURE/KEY NOT PRESENT.

When the Logical Unit is not in the Bus Key Established state for CSS/CPPM, this command with KEY Format = 000100b shall be terminated with CHECK CONDITION status and SK/ASC/ASCQ shall be set to ILLEGAL REQUEST/COPY PROTECTION KEY EXCHANGE FAILURE – KEY NOT ESTABLISHED.

6.33.3.5 Key Format = 000101b, Authentication Success Flag

Table 477 defines the response data for Key Format 000101b.

ASF bit of one indicates that the authentication process for CSS/CPPM has completed successfully.

Note, however, that the ASF value is not relevant to CPPM, since CPPM protected sectors do not contain a Title Key.

Table 477 – REPORT KEY Data Format (With KEY Format = 000101b, Key Class = 0)

Bit	7	6	5	4	3	2	1	0	
Byte									
0	(MSB) REPORT KEY Data Length (06h)								
1								(LSB)	
2	Reserved								
3	Reserved								
AUTHENTICATION SUCCESS FLAG									
0	Reserved								
1	Reserved								
2	Reserved								
3	Reserved							ASF	

6.33.3.6 Key Format = 001000b, RPC State

Table 478 defines the response data for Key Format 001000b

Table 478 – REPORT KEY Data Format (With KEY Format = 001000b, Key Class = 0)

Bit	7	6	5	4	3	2	1	0
Byte								
0	(MSB) REPORT KEY Data Length (06h) (LSB)							
1								
2	Reserved							
3	Reserved							
RPC State								
0	Type Code	# of Vendor Resets Available			# of User Controlled Changes Available			
1	Region Mask							
2	RPC Scheme							
3	Reserved							

The Logical Unit shall not report an error concerning media to this KEY Format code.

The Type Code field (Table 479) specifies the current state of the Regionalization process.

Table 479 – Type Code Field Definitions

Type Code	Name	Definition
00b	NONE	No Logical Unit region setting
01b	SET	Logical Unit region is set
10b	LAST CHANCE	Logical Unit Region is set. Additional restrictions required to make a change
11b	PERM	Logical Unit Region has been set permanently, but may be reset by the vendor if necessary.

of Vendor Resets Available is a count down counter that indicates the number of times that the vendor may reset the region. The manufacturer of the Logical Unit sets this value to 4 and the value is decremented each time the vendor clears the Logical Unit's region. When this value is zero, the vendor may no longer clear the Logical Unit's region.

of User Controlled Changes Available is a count down counter that indicates the number of times that the user may set the region. This value is initially 5.

The Region Mask returns a value that specifies the Logical Unit Region in which the Logical Unit is located. Once the Logical Unit Region has been set, the Logical Unit shall be located in only one region. Each bit represents one of eight regions. If a bit is cleared in this field, the disc may be played in the corresponding region. If a bit is set in this field, the disc may not be played in the corresponding region.

RPC Scheme specifies the type of Region Playback Controls being used by the Logical Unit. See Table 480.

Table 480 – RPC Scheme field Definition

RPC Scheme	RPC Name	Definition
00h	Unknown	Logical Unit does not enforce Region Playback Controls (RPC)
01h	RPC Phase II	Logical Unit region shall adhere to this standard and all requirements of the CSS license agreement concerning RPC.
02h – FFh	Reserved	

6.33.3.7 Key Format = 010001b, AGID for CPRM

Table 481 defines the response data for Key Format 010001b

This KEY Format requests the Logical Unit to return an Authentication Grant ID for CPRM. If the authentication process is started by the REPORT KEY command with a KEY Format of 010001b, the authentication shall be processed to exchange Key data only for CPRM protected contents.

NOTE 27: If the command with this KEY Format is required by an implemented Feature, the command should function, even when the current bit for that Feature is zero.

Table 481 – REPORT KEY Data Format (With Key Format = 010001b, Key Class = 0)

Byte	Bit	7	6	5	4	3	2	1	0
0	(MSB)	REPORT KEY Data Length (06h)							
1									
2		Reserved							
3		Reserved							
AUTHENTICATION GRANT ID FOR CPRM									
0		Reserved							
1		Reserved							
2		Reserved							
3		AGID	Reserved						

6.33.3.8 Key Format = 111111b, Invalidate AGID

When Key Format is 111111b, specified AGID shall be invalidated. No further conversation is allowed over this AGID until it is assigned again with a new REPORT KEY command requesting an AGID. There is no returned data when Key Format = 111111b.

6.33.4 Timeouts

The REPORT KEY command belongs to timeout group 1. If the command is terminated with CHECK CONDITION status due to a timeout, sense bytes SK/ASC/ASCQ shall be set to UNIT ATTENTION/INSUFFICIENT TIME FOR OPERATION.

6.33.5 Error Reporting

Recommended error reporting for the REPORT KEY command is defined in Table 482.

Table 482 – Recommended errors for REPORT KEY Command

Error	Reference
Unit Attention conditions	Table F.1
CDB or parameter list validation errors	Table F.2
General media access errors	Table F.5
Hardware failures	Table F.8

6.34 REQUEST SENSE Command

6.34.1 Introduction

The REQUEST SENSE command requests that the Logical Unit transfer sense data to the Initiator. Table 483 shows the Features associated with the REQUEST SENSE command.

Table 483 – Features Associated with the REQUEST SENSE Command

Feature Number	Feature Name	Command Requirement
0001h	Core	Mandatory
0023h	Formattable	Mandatory

The REQUEST SENSE command is described in SPC-3.

MM Logical Units that support only a 32-bit LBA format, shall return only fixed format sense data. Such MM Logical Units may ignore the setting of the Desc bit in the REQUEST SENSE command CDB.

6.34.2 Timeouts

Timeouts are not defined for the REQUEST SENSE command.

6.34.3 Error Reporting

Recommended error reporting for the REQUEST SENSE command is defined in Table 484.

Table 484 – Recommended errors for REQUEST SENSE Command

Error	Reference
CDB or parameter list validation errors	Table F.2
Hardware failures	Table F.8

6.35 RESERVE TRACK Command

6.35.1 Introduction

The RESERVE TRACK command allows reservation of disc space for a logical track.

Table 485 shows the Features associated with the RESERVE TRACK command.

Table 485 – Features Associated with the RESERVE TRACK Command

Feature Number	Feature Name	Command Requirement
0021h	Incremental Streaming Writable	Mandatory
002Bh	DVD+R	Mandatory (when Write bit is set to one)
002Dh	CD Track At Once	Mandatory
002Fh	DVD-R/-RW	Mandatory
0031h	DDCD-R Write	Mandatory
0032h	DDCD-RW Write	Mandatory

6.35.2 The CDB and Its Parameters

The RESERVE TRACK CDB is shown in Table 486.

Table 486 – RESERVE TRACK CDB

Bit	7	6	5	4	3	2	1	0
0	Operation Code (53h)							
1	Reserved							
2	Reserved							
3	Reserved							
4	Reserved							
5	(MSB) (LSB)							
6								
7								
8								
9	Control Byte							

The Reservation Size field contains the number of user blocks desired for the track reservation. The actual number of blocks allocated is calculated according to the currently mounted media and may be influenced by the Write Parameters Mode Page (See 7.4). Rounding is permitted. In all cases, if Reservation Size is larger than available space, the command shall be terminated with CHECK CONDITION status and SK/ASC/ASCQ values shall be set to ILLEGAL REQUEST/INVALID PARAMETER IN CDB.

6.35.3 Command Execution

6.35.3.1 General

If the Logical Unit is unable to write to the currently mounted medium, error reporting should follow the guidelines according to 4.1.6.3.

Regardless of media type, allowing an attempt to reserve a track when the invisible track is not blank is not recommended. The preferred behavior is: the command should be terminated with CHECK CONDITION status and sense bytes SK/ASC/ASCQ should be set to ILLEGAL REQUEST/COMMAND SEQUENCE ERROR.

6.35.3.2 Track Reservation on CD-R/RW Media

If Reservation Size is less than 300 (4 seconds), the command shall be terminated with CHECK CONDITION status and SK/ASC/ASCQ values shall be set to ILLEGAL REQUEST/INVALID PARAMETER IN CDB.

The PMA start time shall reflect the appropriate pre-gap, as determined by the previous track's mode and the settings of the Write Parameters Page. Table 487 specifies the PMA stop time, and Track sizing.

Table 487 – Track Reservation on CD-R/-RW Media

Write Parameters Mode Page Write Type Value	Description
Session-at-once	CHECK CONDITION status is returned and SK/ASC/ASCQ is set to ILLEGAL REQUEST/COMMAND SEQUENCE ERROR
Track-at-once	The number of user blocks specified shall be reserved. The PMA stop time shall be $PMAStart + ReservationSize + 2$.
Variable Packet	Reserve behaves as in the Track-At-Once case. The Initiator should be aware that packet linkage overheads is taken from the user space.
Fixed Packet	Set $p = \frac{ReservationSize}{PacketSize}$ packets, where packet size is taken from the Write Parameters Page. If p is an integer, then the reservation is performed with PMA stop time set to $PMAStart + (PacketSize + 7) \cdot p - 5$. If p is not an integer, the command shall be terminated with CHECK CONDITION status and SK/ASC/ASCQ is set to ILLEGAL REQUEST/INVALID FIELD IN CDB.

6.35.3.3 Track (Rzone) Reservation on DVD-R/-RW Media

Reservation Size is given as a count of 2 KB sectors. If this number is not an integral multiple of 16, then the Logical Unit shall round to the next integral multiple of 16. This is the value used by the Logical Unit. A track always begins with the first sector of an ECC block.

Table 488 – Track Reservation on DVD-R/-RW Media

Write Parameters Mode Page Write Type Value	Reserved Track Size
Disc-at-once	Reserves the number of user blocks specified. The Reserved Track shall be $ReservedTrackSize = ReservationSize$.
Incremental	Reserves the number of user blocks specified. The Reserved Track Size shall be $ReservedTrack = 16 \cdot Cell \left\lceil \frac{ReservationSize + (NWA \wedge 0Fh)}{16} \right\rceil - (NWA \wedge 0Fh) + 16$ where $ReservationSize$ is a value that is specified in the CDB. NWA is a Next Writable Address of invisible Track. \wedge means mathematical AND. $+16$ means BSGA

6.35.3.4 Track (Fragment) Reservation on DVD+R Media

Reservation Size is given as a count of 2 KB sectors. If this number is not an integral multiple of 16, then the Logical Unit shall round to the next integral multiple of 16. This is the value used by the Logical Unit. A track always begins with the first sector of an ECC block. A run-in ECC block shall be written between any two tracks within a session just prior to writing the first ECC block of the following track. The run-in ECC block does not belong to either the previous or the new track. If this track is the first track of a session, then no run-in block shall be allocated.

6.35.4 Timeouts

The RESERVE TRACK command belongs to timeout group 2. The group 2 timeout value is only for Initiator information. The Logical Unit shall not time group 2 timeout commands. Execution shall continue until completion.

6.35.5 Error Reporting

Recommended error reporting for the RESERVE TRACK command is defined in Table 489.

Table 489 – Recommended errors for RESERVE TRACK Command

Error	Reference
Unit Attention conditions	Table F.1
CDB or parameter list validation errors	Table F.2
Readiness errors	Table F.3
General media access errors	Table F.5
Hardware failures	Table F.8

6.36 SCAN Command

6.36.1 Introduction

The SCAN command requests a forward or reverse scan operation beginning at the Scan Starting Address. The Logical Unit shall respond to this command by scanning to the end of the last audio track on the media.

Table 490 shows the Features associated with the READ SUB-CHANNEL command.

Table 490 – Features Associated with the SCAN Command

Feature Number	Feature Name	Command Requirement
0103h	CD Audio External Play	When Scan bit is set in Feature Descriptor

6.36.2 The CDB and Its Parameters

6.36.2.1 The CDB

The SCAN CDB is shown in Table 491.

Table 491 – SCAN CDB

Byte	Bit	7	6	5	4	3	2	1	0
0		OPERATION CODE (BAh)							
1		Reserved			Direction	Reserved			RelAdr
2	(MSB)	Scan Starting Address							
3									
4									
5									
6		Reserved							
7		Reserved							
8		Reserved							
9		Type	Reserved						
10		Reserved							
11		Control							

6.36.2.2 Direction

If Direction is zero, the Logical Unit shall perform a forward scan operation. If Direction is set to one, the Logical Unit shall perform a reverse scan operation.

6.36.2.3 RelAdr

The RelAdr bit is not used by MM devices and shall be set to zero.

6.36.2.4 Scan Starting Address

The Scan Starting Address specifies the address at which the audio scanning operation shall begin.

6.36.2.5 Type

The Type field specifies the format of the Scan Starting Address. The meaning of each type code is shown in Table 492.

Table 492 – Type Field Bit Definitions

Bits 7 – 6	Address Type	CDB Format
0 0	Logical Block Address	32-bit Integer with MSB in CDB byte 2 and LSB in CDB byte 5
0 1	Time	Byte 2 is reserved, Byte 3 = Minute field, Byte 4 = Second field, Byte 5 = Frame field
1 0	Track Number	32-bit Integer with MSB in CDB byte 2 and LSB in CDB byte 5
1 1	Reserved	—

When the address type is a track number, the scan operation shall begin with the start address of the specified track.

6.36.3 Command Execution

Scanning is a repeated play and jump operation. An example is the following implementation of forward and reverse scan: Forward scan – Play six CD-DA blocks and then jump 190 CD-DA blocks in the forward direction. Reverse Scan – play six CD-DA blocks and then jump 150 CD-DA blocks (from the last block of the six) in the reverse direction.

Like the PLAY AUDIO command, the SCAN command shall terminate the scan at the last audio track or upon receipt of a STOP PLAY/SCAN command. Upon receipt of the STOP PLAY/SCAN command the Logical Unit shall set the current address to the last address of data read from the media by the scan operation. Subsequent Audio Play commands shall cause the Logical Unit to begin playing at the location last output by the SCAN command. If the Logical Unit receives a PAUSE/RESUME command with the resume bit clear, the Logical Unit shall pause. After that, if the Logical Unit receives a PAUSE/RESUME command with the resume bit set, the Logical Unit shall resume audio play, not scan, from the address where the audio pause occurred.

If the Logical Unit receives a SCAN command during play or pause, the Logical Unit shall stop play or pause and perform Scan.

If the Logical Unit encounters a data track, it shall terminate the scan.

Upon receipt of a READ SUB-CHANNEL command during scan, the Logical Unit shall return an Audio Status of 11h (Audio Play operation in Progress).

The Initiator is required to issue PLAY AUDIO command immediately following a STOP PLAY/SCAN command to resume the play audio operation at normal speed.

6.36.4 Timeouts

The SCAN command belongs to timeout group 1. If the command is terminated with CHECK CONDITION status due to a timeout, sense bytes SK/ASC/ASCQ shall be set to UNIT ATTENTION/INSUFFICIENT TIME FOR OPERATION.

6.36.5 Error Reporting

Recommended error reporting for the SCAN command is defined in Table 493.

Table 493 – Recommended errors for SCAN Command

Error	Reference
Unit Attention conditions	Table F.1
CDB or parameter list validation errors	Table F.2
Readiness errors	Table F.3
General media access errors	Table F.5
Hardware failures	Table F.8

6.37 SEEK (10) Command

6.37.1 Introduction

The SEEK (10) command requests that the Logical Unit seek to the specified logical block address. This command allows the Initiator to provide advanced notification that particular data may be requested in a subsequent command.

Table 494 shows the Features associated with the SEEK (10) command.

Table 494 – Features Associated with the SEEK (10) Command

Feature Number	Feature Name	Command Requirement
0103h	CD Audio External Play	Mandatory

6.37.2 The CDB and Its Parameters

6.37.2.1 The CDB

The SEEK (10) CDB is shown in Table 495.

Table 495 – SEEK (10) CDB

Byte	Bit	7	6	5	4	3	2	1	0
0		Operation Code (2Bh)							
1		Reserved							
2	(MSB)	Logical Block Address							
3									
4									
5									
6		Reserved							
7		Reserved							
8		Reserved							
9		Control Byte							

6.37.2.2 Logical Block Address

The Logical Block Address shall be less than or equal to the capacity address returned by the READ CAPACITY command.

6.37.3 Command Execution

The SEEK command may return completion status once the seek operation has been started. The operation should be completed prior to beginning execution of the next command.

If the currently mounted medium is CD-RW with MRW formatting operating in background, DVD+RW with basic formatting operating in background, or DVD+RW with MRW formatting operating in background, the SEEK command operation shall be as follows:

- If any of the sectors within the range specified by the CDB are in a blank area of the media where format writing has not yet occurred, the seek need not be performed.
- If all of the sectors within the range specified by the CDB are in an area of the media where format writing has occurred, the command shall operate normally.

6.37.4 Timeouts

The SEEK (10) command belongs to timeout group 1. If the command is terminated with CHECK CONDITION status due to a timeout, sense bytes SK/ASC/ASCQ shall be set to UNIT ATTENTION/INSUFFICIENT TIME FOR OPERATION.

6.37.5 Error Reporting

Recommended error reporting for the SEEK (10) command is defined in Table 496.

Table 496 – Recommended errors for SEEK (10) Command

Error	Reference	May be Deferred
Unit Attention conditions	Table F.1	
CDB or parameter list validation errors	Table F.2	
Readiness errors	Table F.3	
General media access errors	Table F.5	√
Hardware failures	Table F.8	√

6.38 SEND CUE SHEET Command

6.38.1 Introduction

A Session-at-once recording is written beginning with the Lead-in and continuing through the Lead-out. Only user data is sent with the write commands, so a guide structure is required by the Logical Unit in order to control the recording process. This guide structure is called the cue sheet. The cue sheet is constructed in the Initiator and sent to the Logical Unit.

Table 497 shows the Features associated with the SEND CUE SHEET command.

Table 497 – Features Associated with the SEND CUE SHEET Command

Feature Number	Feature Name	Command Requirement
002Eh	CD Mastering (SAO)	Mandatory

6.38.2 The CDB and Its Parameters

6.38.2.1 The CDB

The SEND CUE SHEET CDB is shown in Table 498.

Table 498 – SEND CUE SHEET CDB

Byte	Bit	7	6	5	4	3	2	1	0
0		Operation Code (5Dh)							
1		Reserved							
2		Reserved							
3		Reserved							
4		Reserved							
5		Reserved							
6	(MSB)	Cue Sheet Size							
7									
8									
9		Control Byte							

The Cue Sheet Size parameter is the number of bytes in the cue sheet to be sent to the Logical Unit. Prior to beginning the write process, the entire Cue Sheet shall be received by the Logical Unit. If the Logical Unit is unable to accept and buffer the entire cue sheet, then CHECK CONDITION is returned and SK/ASC/ASCQ values are set to ILLEGAL REQUEST/INVALID FIELD IN CDB.

6.38.3 Command Execution

6.38.3.1 General

If the Write Parameters Page does not have Write Type set to Session-at-once, then CHECK CONDITION status is returned and SK/ASC/ASCQ values are set to ILLEGAL REQUEST/COMMAND SEQUENCE ERROR.

If the Write Mode in the Write Parameters Mode Page, is changed from session at once, the Cue sheet may not be available.

The Cue Sheet contains information required to specify the layout of a disc to be written, and shall be sent to the Logical Unit via the SEND CUE SHEET command before writing data to the disc.

The Cue Sheet format is shown in Table 499.

Table 499 – Cue Sheet format

Byte Number	Cue Sheet Data
0	Mixture of Information of absolute disc location, catalog Code, and ISRC (total m lines)
...	
(m-1)* 8	

If the Catalog Code is to be recorded, it shall be described at the beginning of the Cue sheet.

If the ISRC is to be recorded, it shall be described immediately preceding each Track's information in the Cue Sheet.

For the Cue sheet, the Lead-out start time shall be the last entry.

6.38.3.2 Information of the Absolute Disc Location

The Logical Unit writes a disc according to this information. This information defines the following parameters:

1. Generation of Sub-channel P and Q channel.
2. Format and block size of the data transferred by the WRITE command

Table 500 – Sample CUE SHEET

Byte Number	CTL/ ADR	TNO	INDEX	DATA FORM	SCMS	ABSOLUTE TIME		
						MIN	SEC	FRAME
00 (Lead-in)	01h ⁵	00h	00h ¹	01h ⁵	00h	00h ¹	00h ¹	00h ¹
08 (TNO:01)	01h	01h	00h	01h	00h	00h	00h	00h
10 (TNO:01) ²	01h	01h	01h	00h	00h	00h	02h	00h
18 (TNO:02)	01h	02h	00h	C0h	00h	07h	29h	71h
20 (TNO:02)	01h	02h	01h	C0h	00h	07h	31h	71h
28 (TNO:03)	01h	03h	01h	C0h	00h	14h	18h	03h
30 (TNO:04) ⁴	41h	04h	00h	10h	00h	19h	06h	62h
38 (TNO:04)	41h	04h	01h	10h	00h	19h	09h	62h
40 (TNO:05) ⁴	41h	05h	00h	11h	00h	27h	37h	10h
48 (TNO:05)	41h	05h	01h	10h	00h	27h	40h	10h
50 (TNO:06)	01h	06h	00h	01h	80h ⁶	38h	53h	23h
58 (TNO:06)	01h	06h	01h	00h	80h ⁶	38h	55h	23h
60 (Lead-out)	01h ⁵	AAh	01h ³	01h ⁵	00h	56h	37h	46h

NOTES:

1. Always zero for Lead-in except when DATA FORM is set to 41h.
2. The first information track on a disc is preceded by a pause encoding of 2-3 seconds. (If the first track is a Data track, this track does not contain pause encoding, but always contains a "pause" of 2 seconds of pre-gap).
3. Always 01h for Lead-out
4. Pre-gap
5. For the Lead-out area the DATA FORM shall be one. For Lead-in, DATA FORM shall be either 01h or 41h. The control mode of the first track is specified. All data for both Lead-in and Lead-out shall be generated by the Logical Unit except if DATA FORM 41h is selected for the Lead-in.
6. Copy

This information is composed of data units of 8 bytes (1 line). The information consists of three parts:

- 1) The Lead-in area, and contains only one data unit.
- 2) The Program area, that contains data units.
- 3) The Lead-out area, and contains one or more data units.

The data units in Program Area and Lead-out area are in Absolute Time order from the start time of index = 0 of the first track of the session.

Each data unit of Program area and Lead-out area indicates that the value of each field (CONTROL, TNO, X, DATA FORM or ZERO) changes at the time shown in ABSOLUTE TIME field.

Table 501 – Cue Sheet Data

CTL/ ADR	TNO	INDEX	DATA FORM	SCMS	ABSOLUTE TIME		
					Min	Sec	Frame
01h	02h	01h	C0h	00h	07h	31h	71h
01h	03h	01h	C0h	00h	14h	18h	03h

The above data unit indicates that the value of TNO changes from 02 to 03 when ABSOLUTE TIME is 14:18:03 MSF.

6.38.3.3 Control/Address Field

The CTL/ADR byte contains the Control field in the upper 4 bits and the ADR in the lower 4 bits. Refer to Table 502.

Table 502 – CTL/ADR byte

7	6	5	4	3	2	1	0
CTL Field				ADR Field			

6.38.3.4 CTL Field (upper 4 bits)

The CTL (Control) field contains 4 bits that define the kind of information in a track. The definition is shown in Table 503.

Table 503 – Control Field

Bit 7	Bit 6	Bit 5	Bit 4	Definition
0	0	x	0	2 audio channels without pre-emphasis
1	0	x	0	4 audio channels without pre-emphasis
0	0	x	1	2 audio channels with pre-emphasis of 50/15 μ s.
1	0	x	1	4 audio channels with pre-emphasis of 50/15 μ s.
0	1	x	0	Data track
x	x	0	x	digital copy prohibited
x	x	1	x	digital copy permitted

The bits of the Control field (except for the copy bit) shall only be changed during an actual pause (Index = 00) of at least 2 seconds and during Lead-in area.

6.38.3.5 ADR Field (lower 4 bits)

Table 504 defines the codes found in the ADR Field.

Table 504 – ADR Field

Bit 3	Bit 2	Bit 1	Bit 0	Definition
0	0	0	1	start time at TNO/IDX
0	0	1	0	CATALOG CODE
0	0	1	1	ISRC CODE

NOTE: All other codes are reserved for future use.

Control shall be the same for each entry associated with a particular track except for first part of pre-gap.

6.38.3.6 TNO

The TNO field indicates track number. Although the TNO field appears in BCD on the media, this field shall contain the binary equivalent. Each track has a minimum length of 4 seconds, not including the pause length preceding the track.

6.38.3.7 INDEX Field

INDEX field is the current value of the index number. Although the INDEX field appears in BCD on the media, the field in this structure shall contain the binary equivalent. The Logical Unit supports only 00h to 63h.

6.38.3.8 Data Form

Table 505 defines the data form byte.

Table 505 – Data Form Byte

7	6	5	4	3	2	1	0
Data Form of Sub-channel		Data Form of Main Data					

6.38.3.9 SCMS (Serial Copy Management System)

Bit 7 of data form of 1 indicates that Copy bit of CONTROL field alternates for Serial Copy Management System (see Table 506). The other 7 bits (Reserved) are zero. This bit is effective if Copy bit of the Control Code is zero.

Table 506 – SCMS Byte

7	6	5	4	3	2	1	0
Alternate Copy bit	Reserved						

6.38.3.10 Data Form of Main Data

The Data Form of Main Data field specifies the format of the main data to be sent by a WRITE command to write on the disc. Currently available data formats are 1.) CD-DA, 2.) CD-ROM mode 1, 3.) CD-ROM XA, and CD-I. For Lead-in and Lead-out area data are generated automatically except if Data Form is set to 41h.

6.38.3.11 CD-DA Data Form

Table 507 defines a CD-DA Data Form for one frame.

Table 507 – CD (CD-DA)

Data Form	Data of One Frame	Data Size
00h	2 352	2 352
01h	2 352	0

The CD-DA data format, Table 508, is as follows;

Table 508 – CD-DA Data format (1 Sample)

Byte	Bit	7	6	5	4	3	2	1	0
n*4+0 (L Ch)		L7	L6	L5	L4	L3	L2	L1	L0
n*4+1 (L Ch)		L15	L14	L13	L12	L11	L10	L9	L8
n*4+2 (R Ch)		R7	R6	R5	R4	R3	R2	R1	R0
n*4+3 (R Ch)		R15	R14	R13	R12	R11	R10	R9	R8

n = 0,1, - 587

1 Second = 75 Frames

1 Frame = 588 Samples

1 Sample = 4 bytes (16 bits L, RCh)

6.38.3.12 CD-ROM mode 1 Form

Table 509 defines the form for CD-ROM mode 1.

Table 509 – CD-ROM mode 1

Data Form	Sync/ Header	Data of One Frame	EDC/ECC Area	Data Size
10h	16 ²	2 048 ¹	288 ²	2 048
11h	16 ³	2 048 ¹	288 ³	2 352
12h	16 ²	2 048 ³	288 ²	2 048
13h	16 ³	2 048 ³	288 ³	2 352
14h	16 ²	2 048 ²	288 ²	0

6.38.3.13 CD-ROM XA, CD-I Form

Table 510 defines the form for CD-ROM XA, CD-I.

Table 510 – CD-ROM XA, CD-I

Data Form	Sync/ Header	Sub Header	Data of One Frame	EDC/ECC Area	Data Size	
20h	Form 1	16 ²	8 ¹	2 048 ¹	280 ³	2 336
	Form 2	16 ²	8 ¹	2 324 ¹	4 ³	2 336
21h	Form 1	16 ³	8 ¹	2 048 ¹	280 ³	2 352
	Form 2	16 ³	8 ¹	2 324 ¹	4 ³	2 352
22h	Form 1	16 ²	8 ¹	2 048 ³	280 ³	2 336
	Form 2	16 ²	8 ¹	2 324 ³	4 ³	2 336
23h	Form 1	16 ³	8 ¹	2 048 ³	280 ³	2 352
	Form 2	16 ³	8 ¹	2 324 ³	4 ³	2 352
24h	Form 1	NA	NA	NA	NA	NA
	Form 2	16 ²	8 ²	2 324 ²	4 ²	0

Reserved Area: The Reserved Area contains 4 bytes that are reserved for quality control during the disc production process. In case of Generate Zero, the Logical Unit generates zero data of 4 bytes for this area.

6.38.3.14 CD-ROM mode 2

Table 511 defines the form for CD-ROM mode 2.

Table 511 – CD-ROM Mode 2

Data Form	Sync/ Header	Data of One Frame	Data Size
30h	16 ²	2 336 ¹	2 336
31h	16 ³	2 336 ¹	2 352
32h	16 ²	2 336 ³	2 336
33h	16 ³	2 336 ³	2 352
34h	16 ²	2 336 ²	0

For all forms:

1. Read Buffer: The data is sent by the Initiator.
2. Generate Data: The Logical Unit generates the data in this area. The Initiator should not send the data for this area. All sectors in the program area shall have an associated write, even if all data for the sector is to be generated by the Logical Unit. Zero bytes shall be transferred for such sectors.
3. Ignore Buffer: The Logical Unit receives the data for this area from the Initiator with Write command. However, the Logical Unit ignores the data and generates data for this area.

6.38.3.15 Data Form of Sub-channel

The DATA FORM OF SUB-CHANNEL (Table 512) field specifies the format of the Sub-channel data stored in the inner buffer by WRITE command to write on the disc.

Table 512 – Data Form of Sub-channel

Data Form		Data of One Frame				Data Size
Bit 7	Bit 6					
0	0	96 *1				0
0	1	96 *2				96
1	0	Reserved				
1	1	24 Pack ³	24 Pack ³	24 Pack ³	24 Pack ³	96

NOTES:

1. Generate zero data
2. RAW Data
3. PACK DATA, Initiator sends packed data. The Logical Unit writes R-W. The Logical Unit calculates and overwrites ECC, and performs Interleaving for each PACK.

When this Data Form of Sub-channel is selected, along with 01h Data Form of Main Data, this indicates that there is an attempt to write Raw P-W Sub-channel data in the Lead-in. Absolute Time field should be set with the start address of the Lead-in, that may be read via a READ TRACK INFORMATION command for track 0. In this case, the Data Block Type of the Write Parameters Page should be set to 2, 3, or 4.

The Sub-channel data is placed at the end of each Frame of main data. Figure 49 shows the relationship of Main Data and Sub-channel data.

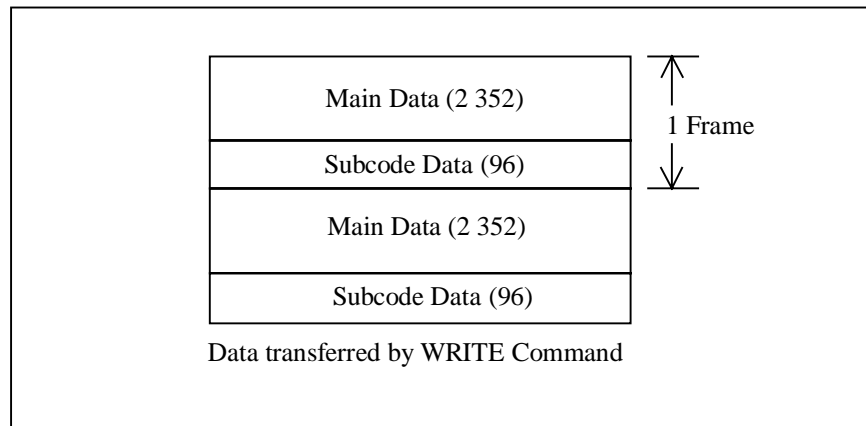

Figure 49 – Location of Sub-channel Data

The P and Q Sub-channel information contained within the Sub-code Data shall be ignored. The P and Q Sub-channel information is generated by the Logical Unit and based on the content of the cue sheet.

6.38.3.16 Absolute Time

The time shown at Min, Sec, and Frame gives the changing point of the CONTROL, TNO, X, DATA FORM or SCMS field. These values are given in absolute time scale.

6.38.3.17 Session Format

The Session Format is used for the identification of the type of disc. Refer to Table 456.

6.38.3.18 Pre-gap

If a Data track is preceded by a different mode of track (such as an audio track) or if the mode number of CD-ROM changes, this Data track starts with an extended pre-gap. A pre-gap is placed at the head of a Data track, also is belonging to the Data track. A pre-gap does not contain actual user data. The pre-gap is encoded as "pause."

An extended pre-gap is divided into two parts. The first part of the extended pre-gap has a minimum 1 second of data, and it is encoded according to the data structure of previous track. The second part has a minimum 2 seconds data, and this data track is encoded according to the same data structure as the other parts.

6.38.3.19 Post-gap

If a Data track is followed by another kind of track (such as an audio track), this Data track ends with a post-gap. A post-gap is placed at the end of a Data track, and is part of the Data Track. A post-gap does not contain actual user data. The minimum length of post-gap is 2 seconds. The Logical Unit does not perform any action for a Post-gap.

6.38.3.20 Media Catalog Number

Table 513, Catalog Number, indicates the catalog number of a disc. The number uses UPC/EAN-code (BAR coding). If no catalog number is used, it shall be omitted. The format is as follows;

Table 513 – Media Catalog Number (N1..N13)

CTL/ ADR	Catalog Number						
Byte 0	Byte 1	Byte 2	Byte 3	Byte 4	Byte 5	Byte 6	Byte 7
02h	N1	N2	N3	N4	N5	N6	N7
02h	N8	N9	N10	N11	N12	N13	00h

NOTE: The format of the data recorded in the Sub-channel area is not identical to that specified in the Write Parameter Mode Page.

N1-N13 Catalog Number

CTL: 4 bits are zero.

ADR: 0010b

Catalog Number: ASCII 13 BYTES

6.38.3.21 ISRC

Table 514, ISRC (International Standard Recording Code), is a code that is given to CD-DA tracks. If no ISRC is used, it shall be omitted. If a track has no ISRC, it is not written in the Cue Sheet.

Table 514 – ISRC (I1..I12)

CTL/ ADR	ISRC(International Standard Recording Code)							
	byte 0	byte 1	byte 2	byte 3	byte 4	byte 5	byte 6	byte 7
x3h	TNO	I1	I2	I3	I4	I5	I6	I6
x3h	TNO	I7	I8	I9	I10	I11	I12	I12

NOTE 28: The format of the data recorded in the Sub-channel area is not identical to that specified in the Write Parameter Mode Page.

CTL: 4 bits of Control code are the same as that of disc location of the specified track

ADR: 0011b

TNO: Track number in HEX.

12 letters ISRC (On the Cue Sheet, I1-I12 shall be described by valid ASCII characters. See Table 514 for valid codes.

I1-I2: Country Code

I3-I5: Owner Code

I6-I7: Year of recording

I8-I12: Serial Number

6.38.4 Timeouts

The SEND CUE SHEET command belongs to timeout group 1. If the command is terminated with CHECK CONDITION status due to a timeout, sense bytes SK/ASC/ASCQ shall be set to UNIT ATTENTION/INSUFFICIENT TIME FOR OPERATION.

6.38.5 Error Reporting

Recommended error reporting for the SEND CUE SHEET command is defined in Table 515.

Table 515 – Recommended errors for SEND CUE SHEET Command

Error	Reference
Unit Attention conditions	Table F.1
CDB or parameter list validation errors	Table F.2

6.39 SEND DVD STRUCTURE Command

6.39.1 Introduction

The SEND DVD STRUCTURE command provides a means for the Initiator to transfer DVD STRUCTURE data to the Logical Unit.

Table 516 shows the Features associated with the SEND DVD STRUCTURE command.

Table 516 – Features Associated with the SEND DVD STRUCTURE Command

Feature Number	Feature Name	Command Requirement
0004h	Write Protect	Format C0h, when SPWP is set.
002Ah	DVD+RW	Format codes 05h and 30h (when Write bit in Feature Descriptor is set to one)
002Bh	DVD+R	Format code 05h (when Write bit in Feature Descriptor is set to one)
002Fh	DVD-R/-RW	Mandatory
010Ah	DCB	Mandatory when writable DCBs supported

6.39.2 The CDB and Its Parameters

6.39.2.1 The CDB

The SEND DVD STRUCTURE CDB is shown in Table 517.

Table 517 – SEND DVD STRUCTURE CDB

Bit	7	6	5	4	3	2	1	0
Byte								
0	Operation Code (BFh)							
1	Reserved							
2	Reserved							
3	Reserved							
4	Reserved							
5	Reserved							
6	Reserved							
7	Format							
8	(MSB)	Parameter List Length						(LSB)
9								
10	Reserved							
11	Control							

6.39.2.2 Format

The Format field (Table 518) indicates the type of information to be sent to the device. If the currently mounted media is not a Writable DVD type, the command shall be terminated with CHECK CONDITION status and SK/ASC/ASCQ values are set to ILLEGAL REQUEST/ CANNOT READ MEDIUM – INCOMPATIBLE FORMAT. If the device/media does not support the specified format code, the command shall be terminated with CHECK CONDITION status and SK/ASC/ASCQ values are set to ILLEGAL REQUEST/INVALID FIELD IN CDB.

Table 518 – Format Field Definition

Format Code	Data	Description
00h – 03h	Reserved	
04h	User Specific Data	Send User Specific Data to the RMD cache
05h	Copyright Management	Send data to CPR_MAI in data area cache. (CPM, CGMS, ADP_TY)
06h – 0Eh	Reserved	
0Fh	Timestamp	Send Timestamp data to the RMD cache
10h – 2Fh	Reserved	
30h	Disc Control Block	Send a Disc Control Block
31h – BFh	Reserved	
C0h	Write Protection	Send PWP status
C1h – FFh	Reserved	

6.39.2.3 Parameter List Length

The Parameter List Length field specifies the length in bytes of the DVD STRUCTURE data to be transferred from the Initiator to the Logical Unit after the CDB is transferred. A Structure Data Length field of zero indicates that no data shall be transferred. This condition shall not be considered an error.

6.39.3 Command Execution

6.39.3.1 General

If the Logical Unit is unable to write to the currently mounted medium, error reporting should follow the guidelines according to 4.1.6.3.

6.39.3.2 Format Code = 04h: User Specific Data

Table 519 defines the response data format for User Specific Data, Format code 04h

Table 519 – SEND DVD STRUCTURE Data Format (Format Code = 04h)

Bit	7	6	5	4	3	2	1	0
Byte								
0	(MSB) DVD STRUCTURE Data Length (LSB)							
1								
2	Reserved							
3	Reserved							
DVD-R User Specific Data								
0	(MSB) User Specific Data (LSB)							
...								
2047								

The DVD STRUCTURE Data Length field specifies the length in bytes of the User Specific Data to follow. A DVD Structure Data Length field of zero indicates that no User Specific Data shall be transferred. This condition shall not be considered an error.

The User Specific Data field contains user specific data. This data shall be used to specify the RMD Field 2, and when writing Lead-in the contents of this field shall also be written in Disc manufacturing information field of Lead-in or Border-in.

6.39.3.3 Format Code = 05h: Copyright Management Information

Table 520 describes the response data format for Copyright Management Information, format code 05h.

Table 520 – SEND DVD STRUCTURE Data Format (Format Code = 05h)

Byte	Bit	7	6	5	4	3	2	1	0
0	(MSB)	DVD STRUCTURE Data Length							
1		(LSB)							
2		Reserved							
3		Reserved							
Copyright Management Information in data area									
0		CPR_MAI							
1		Reserved							
2		Reserved							
3		Reserved							

The DVD STRUCTURE Data Length field specifies the length in bytes of the Copyright Management data to follow. A DVD Structure Data Length field of zero indicates that no Copyright Management data shall be transferred. This condition shall not be considered an error.

The definition of the CPR_MAI field depends on the mounted media. The CPR_MAI field definition is shown in Table 521.

Table 521 – CPR_MAI Field Definitions

Media	Bit	7	6	5	4	3	2	1	0
DVD-R, ver 1.0 DVD-RW, ver 1.0		CPM	Resvd	CGMS		Reserved			
DVD-RAM Ver.1.0/2.1 DVD-R for Authoring Ver .2.0		Reserved							
DVD-R for General, ver 2.0, DVD-RW, ver 1.1 and DVD+RW		Reserved				ADP_TY		Reserved	

If the CPM bit is set to 0, shall indicate that this sector contains no copyrighted material. If the CPM bit is set to 1, shall indicate that this sector contains copyrighted material. If this structure is not sent, the default value of the CPM bit shall be 0.

When the CPM bit is set to 0, the CGMS field shall be set to 00b.

When the CPM bit is set to 1, the CGMS field shall be set as shown in Table 522.

Table 522 – CGMS Field Values

CGMS	Definition
00b	Copying is permitted without restriction
01b	Reserved
10b	One generation of copies may be made
11b	No copying is permitted

The identical CGMS value of CPR_MAI in data area shall match with this format following write operation.

The ADP_TY field is defined for DVD-RW Ver.1.1, DVD-R for General Ver. 2.0, and DVD+RW media. If the sector contains materials defined in DVD Specifications for Read-Only Disc Part 3 VIDEO SPECIFICATIONS, the ADP_TY field shall be set to 01b. If the sector contains no such data, ADP_TY field shall be set to 00b. All other values of ADP_TY are reserved.

NOTE 29: Due to the nature of the recording method for DVD-R/-RW media, a value of each field may vary during first and last 16 sectors of each recording extent.

6.39.4 Format Code = 0Fh: Timestamp

The format of Timestamp field is structured as shown in Table 345. This format code is used to set Unique Disc Identifier field of RMD (Recording Management Data) for DVD-R. This time stamp data may also be used in OPC related field in RMD Field 1 and may help the judgement to do OPC.

The time should be current UTC (Universal Coordinated Time) 24 hour clock.

Table 523 – SEND DVD STRUCTURE Data Format (Format Code = 0Fh)

Bit	7	6	5	4	3	2	1	0
Byte								
0	(MSB) DVD STRUCTURE Data Length							
1	(LSB)							
2	Reserved							
3	Reserved							
DVD Timestamp Data								
0	Reserved							
1	Reserved							
2	Reserved							
3	Reserved							
4	(MSB) Year							
5								
6								
7	(LSB)							
8	(MSB) Month							
9	(LSB)							
10	(MSB) Day							
11	(LSB)							
12	(MSB) Hour							
13	(LSB)							
14	(MSB) Minute							
15	(LSB)							
16	(MSB) Second							
17	(LSB)							

The DVD STRUCTURE Data Length field specifies the length in bytes of the DVD Timestamp Data to follow. A DVD Structure Data Length field of zero indicates that no DVD Timestamp Data shall be transferred. This condition shall not be considered an error.

The Year field shall specify the year that coded as ASCII in the range "0001" to "9999".

The Month field shall specify the month of the year that coded as ASCII in the range "01" to "12".

The Day field shall specify the day of the month that coded as ASCII in the range "01" to "31".

The Hour field shall specify the hour of the day that coded as ASCII in the range "00" to "23".

The Minute field shall specify the minute of the hour that coded as ASCII in the range "00" to "59".

The Second field shall specify the second of the minute that coded as ASCII in the range "00" to "59".

6.39.5 Format Code = 30h: Disc Control Block

6.39.5.1 General

Disc Control Block data returned is formatted as shown in Table 524.

Table 524 – SEND DVD STRUCTURE Data Format (Format field = 30h)

Byte	Bit	7	6	5	4	3	2	1	0
0	(MSB)	DVD STRUCTURE Data Length							
1		(LSB)							
2		Reserved							Erase
3		Reserved							
Specific Disc Control Block Information									
0		DCB							
...									
32767									

The DVD STRUCTURE Data Length specifies the length in bytes of the following DVD STRUCTURE data that is available to be transferred to the Initiator. The DVD STRUCTURE Data Length value does not include the DVD STRUCTURE Data Length field itself.

The Erase bit, when set to zero, shall indicate that the Disc Control Block be written to the media. When set to one, it shall indicate that each Disc Control Block on the medium, with a Content Descriptor matching the one sent, shall be erased.

The Logical Unit shall not record any DCB unknown to the Logical Unit.

The Disc Control Block field is defined in the *DVD+R 4,7 Gbytes Basic Formats Specifications* and *DVD+RW 4,7 Gbytes Basic Formats Specifications*. If a Disc Control Block, with fewer than 32 768 bytes is sent, the Logical Unit shall pad the Disc Control Block with 00h bytes.

6.39.5.2 Erasing a DCB

For some DCBs, it is sufficient to include only the DVD Structure header (4 bytes) followed by the DCB content descriptor (4 bytes). For others (e.g. WDCB) the entire DCB information shall be sent.

6.39.5.3 Write Inhibit DCB

The Write Inhibit DCB (WDCB) provides the Initiator with the ability to control write access to the media. If the entire media is write protected, the WDCB is the only writable ECC block on the media and may be written only via the SEND DVD STRUCTURE command with format code = 30h.

Access to the WDCB may be protected by a password (see Table 402). If the WDCB is password protected, writing the WDCB is permitted only when the password field exactly matches the password field of the current WDCB. If the Initiator's password does not match the media password, then the command shall be terminated with CHECK CONDITION status and sense bytes SK/ASC/ASCQ shall be set to ILLEGAL REQUEST/INVALID FIELD IN PARAMETER LIST.

Table 525 shows examples of WDCB management for control of write protect status.

Table 525 – WDCB Management Examples

WDCB Status	Desired Action	Required Command Sequence
No WDCB on media	Write protect the media	Send a valid WDCB.
WDCB present on media – not password protected	Change write protect status	Send a valid WDCB with desired write protect status.
	Password protect current WDCB	Read the DCB to maintain current write protect status. Enable the password and send the WDCB with a valid password in the password field
Password protected WDCB present on media	Change write protect status	Send a valid WDCB with the desired write protect status and the correct password field.
	Change the password	Send a valid WDCB with the desired write protect status and the correct password field. Set the Erase bit in the header. Send a new WDCB with the new password enabled.

If the WDCB Password field is set to all (FF), then the disc is bytesntly wirt protected and further recording on the disc shall not be allowed. This includes formatting.

6.39.6 Format Code = C0h: Write Protection

Table 526 defines data format code C0h.

Table 526 – SEND DVD STRUCTURE Data Format (Format Field = C0h)

Bit	7	6	5	4	3	2	1	0	
Byte									
0	(MSB) Structure Data Length								
1								(LSB)	
2	Reserved								
3	Reserved								
Write Protection Data									
4	Reserved						PWP	Reserved	
5	Reserved								
6	Reserved								
7	Reserved								

The DVD Structure Data Length field shall indicate the number of bytes following this field.

The Persistent Write Protection (PWP) bit of one indicates that the medium surface shall be set to write protected status. The PWP bit of zero indicates that the medium surface shall be set to write permitted status.

If the SEND DVD STRUCTURE command with Format Field set to C0h is sent while the currently mounted medium is DVD+RW, the command shall be terminated with CONDITION STATUS and sense bytes SK/ASC/ASCQ shall be set to ILLEGAL REQUEST/INVALID FIELD IN CDB.

6.39.7 Timeouts

The SEND DVD STRUCTURE command belongs to timeout group 1. If the command is terminated with CHECK CONDITION status due to a timeout, sense bytes SK/ASC/ASCQ shall be set to UNIT ATTENTION/INSUFFICIENT TIME FOR OPERATION.

6.39.8 Error Reporting

Recommended error reporting for the SEND DVD STRUCTURE command is defined in Table 527.

Table 527 – Recommended errors for SEND DVD STRUCTURE Command

Error	Reference
Unit Attention conditions	Table F.1
CDB or parameter list validation errors	Table F.2
Readiness errors	Table F.3
Protocol errors	Table F.4
General media access errors	Table F.5
Write errors	Table F.7
Hardware failures	Table F.8

6.40 SEND KEY Command

6.40.1 Introduction

The SEND KEY command provides data necessary for authentication and for generating a Bus Key for a DVD Logical Unit.

This command, in conjunction with REPORT KEY command, is intended to perform authentication for Logical Units that conform to DVD Content Protection scheme and to generate a Bus Key as the result of authentication.

Table 528 shows the Features associated with the SEND KEY command.

Table 528 – Features Associated with the SEND KEY Command

Feature Number	Feature Name	Command Requirement
0106h	DVD CSS	Mandatory
010Bh	DVD CPRM	Mandatory

6.40.2 The CDB and Its Parameters

6.40.2.1 The CDB

The SEND KEY CDB is shown in Table 529.

Table 529 – SEND KEY CDB

Bit	7	6	5	4	3	2	1	0
Byte 0	Operation Code (A3h)							
1	Reserved							
2	Reserved							
3	Reserved							
4	Reserved							
5	Reserved							
6	Reserved							
7	Key Class							
8	Parameter List Length							
9	(MSB)							(LSB)
10	AGID			Key Format				
11	Control							

6.40.2.2 Key Class

The Key Class field shall identify the type of authentication conversation according to Table 530.

Table 530 – Key Class

Key Class	Authentication Type
00h	DVD CSS/CPM or CPRM
01h	ReWritable Security Service – A
02h – FFh	Reserved

6.40.2.3 Parameter List Length

The Parameter List Length field specifies the length in bytes of the SEND KEY parameter list that shall be transferred from the Initiator to the Logical Unit. A Parameter List Length of zero indicates that no data shall be transferred. This condition shall not be considered an error. If the Parameter List Length results in the truncation of any SEND KEY parameter list, the Logical Unit shall terminate

the command with CHECK CONDITION status and set sense bytes SK/ASC/ASCQ to ILLEGAL REQUEST/PARAMETER LIST LENGTH ERROR.

6.40.2.4 AGID

The AGID field is used to control simultaneous key exchange sequences. The AGID specified in subsequent Key Exchange commands shall match a currently active AGID. An AGID becomes active by requesting one with KEY Format 000000b or 010001b. The AGID remains active until the authentication sequence completes or is invalidated. The AGID field shall be reserved when the KEY Format Field contains 0h, 5h or 11h.

NOTE 30: Logical Units that support more than one KEY Format for requesting an AGID do not necessarily support simultaneous key exchange sequences.

6.40.2.5 KEY Format

The KEY Format field (Table 531) indicates the type of information that is to be sent to the Initiator.

Table 531 – Key Format Code definitions for SEND KEY Command

Key Format	Sent Data	Description	AGID Use
000001b	Challenge Key	Accepts a Challenge Key	Valid AGID required
000011b	KEY2	Accepts a KEY2	
000110b	RPC Structure	Set Region	Reserved & Ignored
111111b	None	Invalidate Specified AGID. Invalidating an invalid AGID shall not be considered an error. An AGID that has not been granted shall be considered invalid.	Valid AGID required
All other values	Reserved		

6.40.3 Command Execution

The Challenge Key (Table 532) is sent to the DVD Logical Unit to get corresponding KEY1 from the DVD Logical Unit to interrogate conformity with DVD Content Protection scheme.

Table 532 – SEND KEY Parameter List (KEY Format field =000001b)

Byte	Bit	7	6	5	4	3	2	1	0
0	(MSB)	SEND KEY Parameter List Length (0Eh)							
1									
2									
3									
Challenge Key Value									
0	(MSB)	Challenge Key Value							
:									
9									
10		Reserved							
11		Reserved							

The KEY2 (Table 533), generated external to the DVD Logical Unit, is sent to the DVD Logical Unit to determine its conformity with DVD Copy Protection scheme. The KEY 2 value shall be used for the second input to generate a Bus Key in the DVD Logical Unit.

When the KEY2 value sent does not conform to the DVD Copy Protection scheme, this command shall be terminated with a CHECK CONDITION status and SK/ASC/ASCQ values are set to ILLEGAL REQUEST/COPY PROTECTION KEY EXCHANGE FAILURE – AUTHENTICATION FAILURE.

If the SEND KEY command with KEY Format = 000011b terminates with CHECK CONDITION status, the retry of authentication shall be performed from the beginning.

Table 533 – SEND KEY Parameter List (KEY Format field =000011b)

Byte	Bit	7	6	5	4	3	2	1	0	
0	(MSB)	SEND KEY Parameter List Length (0Ah)								
1									(LSB)	
2		Reserved								
3		Reserved								
KEY2										
0	(MSB)	KEY2 Value								
:										
4									(LSB)	
5		Reserved								
6		Reserved								
7		Reserved								

The Preferred Logical Unit Regional Code (Table 534) is sent to the DVD Logical Unit to make the Logical Unit regionalized. The Preferred Logical Unit Region Code specifies a single region in which the disc may be played. Each bit represents one of eight regions. If a bit is cleared in this field, the disc may be played in the corresponding region. If a bit is set in this field, the disc is unable to be played in the corresponding region. Exactly one bit of the Preferred Logical Unit Region Code shall contain a zero.

If the Logical Unit does not support setting of the Region, or the Region is no longer changeable, then this command shall be terminated with CHECK CONDITION status and SK/ASC/ASCQ values shall be set to DRIVE REGION MUST BE PERMANENT/REGION RESET COUNT ERROR.

Table 534 – SEND KEY Parameter List (KEY Format field =000110b)

Byte	Bit	7	6	5	4	3	2	1	0	
0	(MSB)	SEND KEY Parameter List Length (06h)								
1									(LSB)	
2							Reserved			
3							Reserved			
RPC Structure										
0		Preferred Logical Unit Region Code								
1		Reserved								
2		Reserved								
3		Reserved								

6.40.4 Timeouts

The SEND KEY command belongs to timeout group 1. If the command is terminated with CHECK CONDITION status due to a timeout, sense bytes SK/ASC/ASCQ shall be set to UNIT ATTENTION/INSUFFICIENT TIME FOR OPERATION.

6.40.5 Error Reporting

Recommended error reporting for the SEND KEY command is defined in Table 535.

Table 535 – Recommended errors for SEND KEY Command

Error	Reference
Unit Attention conditions	Table F.1
CDB or parameter list validation errors	Table F.2
Readiness errors	Table F.3
General media access errors	Table F.5
Hardware failures	Table F.8

6.41 SEND OPC INFORMATION Command

6.41.1 Introduction

The SEND OPC INFORMATION command is used to specify the Optimum Power Calibration (OPC) values to the Logical Unit for the currently mounted medium disc. This command should be used in conjunction with the READ DISC INFORMATION command (6.26).

Table 536 shows the Features associated with the SEND OPC INFORMATION command.

Table 536 – Features Associated with the SEND OPC INFORMATION Command

Feature Number	Feature Name	Command Requirement
0021h	Incremental Streaming Writable	When OPC is reported in Disc Information
002Dh	CD Track At Once	When OPC is reported in Disc Information
002Eh	CD Mastering	When OPC is reported in Disc Information

6.41.2 The CDB and Its Parameters

6.41.2.1 The CDB

The SEND OPC INFORMATION CDB is shown in Table 537.

Table 537 – SEND OPC INFORMATION CDB

Bit	7	6	5	4	3	2	1	0
0	Operation Code (54h)							
1	Reserved							DoOpc
2	Reserved							
3	Reserved							
4	Reserved							
5	Reserved							
6	Reserved							
7	(MSB)	Parameter List Length						(LSB)
8								
9	Control							

6.41.2.2 DoOpc

If DoOpc is set to one, the Logical Unit shall perform an OPC operation to set the OPC values for the current speed. These OPC values shall become current. When DoOpc is set to one, the Parameter List may be sent to indicate an initial value of OPC.

If DoOpc is set to zero, the Logical Unit shall transfer the Parameter List and attempt to set OPC values to those in the Parameter List.

If a Logical Unit supports this command, then it shall support DoOPC = 1.

6.41.2.3 Parameter List Length

The Parameter List Length shall be set to reflect the number of the parameter bytes to be transferred. The Parameter List Length shall be an integral multiple of eight. If the Parameter List Length is not an integral multiple of 8, the command shall be terminated with CHECK CONDITION status and sense bytes SK/ASC/ASCQ shall be set to ILLEGAL REQUEST/INVALID FIELD IN CDB. A Parameter List Length field of zero shall not be considered an error.

If an illegal OPC table entry is detected, the logical unit shall report terminate the command with CHECK CONDITION Status and set sense bytes SK/ASC/ASCQ to ILLEGAL REQUEST/INVALID FIELD IN PARAMETER LIST.

The format of the Parameter List is shown in Table 538.

Table 538 – SEND OPC INFORMATION Parameter List

Byte	Bit	7	6	5	4	3	2	1	0
0	(MSB)	OPC Speed in kBytes per Second							
1									
2	(MSB)	OPC Values							
3									
4									
5									
6									
7	(LSB)								

The OPC Speed is the medium speed with which the OPC Values are associated.

The OPC Values are device, media, and speed specific.

The READ DISC INFORMATION command may return current OPC information for each write speed supported. These values may be saved in order to avoid calibration upon future media remount.

6.41.3 Command Execution

If the Logical Unit is unable to write to the currently mounted medium, error reporting should follow the guidelines according to 0.

If DoOpC is requested, and the medium is not already calibrated, the Logical Unit shall perform OPC in order to determine parameters for each speed. If the Logical Unit has already performed calibration since the currently mounted medium first became ready, a new calibration is optional. The OPC parameters shall be made available to the Initiator via the READ DISC INFORMATION command.

If DoOpC is not requested, the parameter list shall be transferred and the OPC parameters shall be made current.

6.41.4 Timeouts

The SEND OPC INFORMATION command belongs to timeout group 1. If the command is terminated with CHECK CONDITION status due to a timeout, sense bytes SK/ASC/ASCQ shall be set to UNIT ATTENTION/INSUFFICIENT TIME FOR OPERATION.

6.41.5 Error Reporting

Recommended error reporting for the SEND OPC INFORMATION command is defined in Table 539.

Table 539 – Recommended errors for SEND OPC INFORMATION Command

Error	Reference
Unit Attention conditions	Table F.1
CDB or parameter list validation errors	Table F.2
Readiness errors	Table F.3
General media access errors	Table F.5
Hardware failures	Table F.8

6.42 SET CD SPEED Command

6.42.1 Introduction

The SET CD SPEED command provides an Initiator with a method to select a preferred physical speed for CD media.

Table 540 shows the Features associated with the SET CD SPEED command.

Table 540 – Features Associated with the SET CD SPEED Command

Feature Number	Feature Name	Command Requirement
0107h	Real-time Streaming	Optional

6.42.2 The CDB and Its Parameters

6.42.2.1 The CDB

The SET CD SPEED CDB is shown in Table 541.

Table 541 – SET CD SPEED CDB

Byte	Bit	7	6	5	4	3	2	1	0	
0		Operation Code (BBh)								
1		Reserved						Rotational Control		
2	(MSB)	Logical Unit Read Speed (□bytes/sec)								
3									(LSB)	
4	(MSB)	Logical Unit Write Speed (□bytes/sec)								
5									(LSB)	
6		Reserved								
7		Reserved								
8		Reserved								
9		Reserved								
10		Reserved								
11		Control								

6.42.2.2 Rotational Control

Rotational Control identifies how the Logical Unit shall interpret the requested Logical Unit Write Speed.

Table 542 – Rotational Control Parameter

Rotational Control	Meaning
00b	CLV and non-pure CAV
01b	Pure CAV
10b	Reserved
11b	Reserved

In the case of non-CLV rotational control on CD media, the Logical Unit Write Speed shall be assumed to reference the speed at 79:59:74 MSF.

6.42.2.3 Logical Unit Read Speed

A Logical Unit Read Speed of 0000h through FFFh specifies a minimum read speed required by the Initiator. A value of FFFFh requests that the Logical Unit Read Speed be set for optimal performance.

6.42.2.4 Logical Unit Write Speed

A Logical Unit Write Speed of 0000h through FFFEh specifies the write speed required by the Initiator. A value of FFFFh requests that the Logical Unit Write Speed be set for optimal performance. If the Logical Unit is requested to write at an unsupported speed, the Logical Unit shall select any slower Logical Unit Write Speed. This condition is not regarded as an error. If the Logical Unit is requested to write at a speed that is lower than the Logical Unit's slowest speed, the Logical Unit may select an appropriate Write Speed. Otherwise, the Logical Unit shall return CHECK CONDITION status and SK/ASC/ASCQ values are set to ILLEGAL REQUEST/INVALID FIELD IN CDB.

6.42.3 Command Execution

Once the Logical Unit has selected a speed, that speed shall be maintained until the current medium is removed. If the medium is changed and the Logical Unit does not support the former speed, the Logical Unit may select an appropriate speed for the current medium.

It is recommended that the Initiator set the Logical Unit speeds upon the media change.

6.42.4 Timeouts

The SET CD SPEED command belongs to timeout group 1. If the command is terminated with CHECK CONDITION status due to a timeout, sense bytes SK/ASC/ASCQ shall be set to UNIT ATTENTION/INSUFFICIENT TIME FOR OPERATION.

6.42.5 Error Reporting

Recommended error reporting for the SET CD SPEED command is defined in Table 543.

Table 543 – Recommended errors for SET CD SPEED Command

Error	Reference
Unit Attention conditions	Table F.1
CDB or parameter list validation errors	Table F.2
Readiness errors	Table F.3
General media access errors	Table F.5
Write errors	Table F.7
Hardware failures	Table F.8

6.43 SET READ AHEAD Command

6.43.1 Introduction

The SET READ AHEAD command requests that the Logical Unit perform Read Ahead Caching operations from the Read-Ahead Logical Block Address once the Logical Unit encounters the Trigger LBA during its internal read-ahead cacheing operation.

The Read-Ahead operation shall be performed in background, i.e., the Logical Unit shall accept a command during the Read-Ahead operation.

Table 544 shows the Features associated with the SET READ AHEAD command.

Table 544 – Features Associated with the SET READ AHEAD Command

Feature Number	Feature Name	Command Requirement
0107h	Real-time Streaming	Mandatory

6.43.2 The CDB and Its Parameters

6.43.2.1 The CDB

The SET READ AHEAD CDB is shown in Table 545.

Table 545 – SET READ AHEAD CDB

Bit	7	6	5	4	3	2	1	0
0	Operation Code (A7h)							
1	Reserved							
2	Trigger Logical Block Address							
3								
4								
5								
6	Read Ahead Logical Block Address							
7								
8								
9								
10	Reserved							
11	Control							

6.43.2.2 Trigger Logical Block Address

The Trigger Logical Block Address identifies the last sector that shall be cached during the current read-ahead cacheing process.

6.43.2.3 Read-Ahead Logical Block Address

The Read-Ahead Logical Block Address identifies the first sector at which cacheing shall continue.

If the Trigger LBA is equal to the Read Ahead LBA, no action is required and the command shall be terminated with GOOD status.

If the Read-Ahead LBA is less than the Trigger LBA, the command shall be terminated with CHECK CONDITION status and sense bytes SK/ASC/ASCQ shall be set to ILLEGAL REQUEST/.LOGICAL BLOCK ADDRESS OUT OF RANGE.

6.43.3 Command Execution

Three LBAs are involved in determining Logical Unit action: Current cacheing LBA, Trigger LBA, and Read Ahead LBA. Table 546 shows Logical Unit reaction to each case.

Table 546 – Logical Init Reactions to SET READ AHEAD Command

Condition	Logical Unit Response
Current cacheing LBA \leq Trigger LBA < Read Ahead LBA	Read Ahead process shall continue until Trigger LBA data is in cache. The Read Ahead process shall be redirected to the Read Ahead LBA and continue read cacheing. The cache shall contain no data from sectors Trigger LBA+1 through Read Ahead LBA – 1.
Trigger LBA < Current cacheing LBA \leq Read Ahead LBA	Read-ahead process shall be terminated. The Read-ahead process shall be redirected to the Read Ahead LBA and continue read cacheing. All data from sectors Trigger LBA+1 through Read Ahead LBA – 1 should be discarded.
Trigger LBA < Read Ahead LBA \leq Current cacheing LBA	Read Ahead process shall continue. All data from sectors Trigger LBA+1 through Read Ahead LBA – 1 should be discarded.

If the Logical Unit receives this command after the Trigger LBA but before the Read Ahead LBA, data between the Trigger and the Read Ahead LBA shall be discarded and Read Ahead Caching shall be restarted from the specified Read Ahead LBA.

Sectors after the Trigger LBA (Not including the Trigger LBA) should be skipped. The Initiator normally reads the data for both the Trigger and Read Ahead LBA. The sectors between these addresses (exclusive) are normally not read by the Initiator.

6.43.4 Timeouts

The SET READ AHEAD command belongs to timeout group 1. If the command is terminated with CHECK CONDITION status due to a timeout, sense bytes SK/ASC/ASCQ shall be set to UNIT ATTENTION/INSUFFICIENT TIME FOR OPERATION.

6.43.5 Error Reporting

Recommended error reporting for the SET READ AHEAD command is defined in Table 547.

Table 547 – Recommended errors for SET READ AHEAD Command

Error	Reference
Unit Attention conditions	Table F.1
CDB or parameter list validation errors	Table F.2
Readiness errors	Table F.3
General media access errors	Table F.5
Write errors	Table F.7
Hardware failures	Table F.8

6.44 SET STREAMING Command

6.44.1 Introduction

The SET STREAMING command provides the Initiator with a method to communicate requirements for data rate. The performance setting is persistent and remains until a new descriptor is sent. The setting applies only to the extent identified by the Start and End LBA fields. Only zero or one performance extents shall be valid at any time.

If the SET STREAMING Command is used to set performance, the Logical Unit may disable read and write reallocation in the specified region in order to meet the performance criteria.

Table 548 shows the Features associated with the SET STREAMING command.

Table 548 – Features Associated with the SET STREAMING Command

Feature Number	Feature Name	Command Requirement
0107h	Real-time Streaming	Mandatory

6.44.2 The CDB and Its Parameters

6.44.2.1 The CDB

The SET STREAMING CDB is shown in Table 549.

Table 549 – SET STREAMING CDB

Bit	7	6	5	4	3	2	1	0	
Byte									
0	Operation Code (B6h)								
1	Reserved								
2	Reserved								
3	Reserved								
4	Reserved								
5	Reserved								
6	Reserved								
7	Reserved								
8	Type								
9	(MSB)	Parameter List Length							
10								(LSB)	
11	Control								

6.44.2.2 Type

The Type field specifies the type of data that shall be transferred. If the logical unit does not report Enhanced Defect Reporting Feature, Initiator should set the Type field to 0. If the logical unit reports the Enhanced Defect Reporting Feature, the logical unit shall support the Type field. The Type field is defined in Table 550.

If logical unit does not support “Small DBI cache memory model” (see 4.6.4.5.4) and Type field is set to other than 0, the logical unit shall terminate this command with CHECK CONDITION status, INVALID FIELD IN CDB.

Table 550 – Type field definition

Type field value	Reference
0	Performance descriptor
1– 4	Reserved
5	DBI cache zone descriptor
Others	Reserved

6.44.2.3 Parameter List Length

The Parameter List Length field specifies the length in bytes of the Performance Descriptor that shall be transferred from the Initiator to the Logical Unit. A Parameter List Length of zero indicates that no data shall be transferred. This condition shall not be considered as an error.

If the Parameter List Length results in the truncation of Performance Descriptor, the command shall be terminated with CHECK CONDITION status and sense bytes SK/ASC/ASCQ shall be set to ILLEGAL REQUEST/PARAMETER LIST LENGTH ERROR.

6.44.3 Command Execution

6.44.3.1 General

The SET STREAMING command provides a way for the Initiator to indicate to the logical unit that the application has specific request or requirements for logical unit performance.

6.44.3.2 Performance Descriptor (Type=0)

The Initiator should send a Performance Descriptor during the data phase of this command. The Performance Descriptor shall be sent in the format shown in Table 551.

Table 551 – Performance Descriptor

Bit	7	6	5	4	3	2	1	0
Byte								
0	Reserved			WRC		RDD	Exact	RA
1	Reserved							
2	Reserved							
3	Reserved							
4	(MSB)							
...								
7								
8	(MSB)							
...								
11								
12	(MSB)							
...								
15								
16	(MSB)							
...								
19								
20	(MSB)							
...								
23								
24	(MSB)							
...								
27								

The Write Rotation Control (WRC) field specifies the type of the medium rotation control to write. . If Logical Unit does not support the write rotation control mode specified, the Logical Unit shall generate CHECK CONDITION status and SK/ASC/ASCQ values are set to ILLEGAL REQUEST/INVALID FIELD IN PARAMETER LIST.

The RDD (Restore Logical Unit Defaults) bit, when set to zero, indicates the remaining fields are valid. When set to one, it shall indicate that the Logical Unit is to return to its default performance settings and the remaining fields in this descriptor shall be ignored. Read and Write reallocation ability shall be restored to the operation specified by the Read/Write Error Recovery Mode Page.

The Exact bit, when set to zero, shall indicate that the Logical Unit shall set its internal configuration

to match the parameters as best as possible. No errors shall occur. When set to one, the Logical Unit shall set its internal configuration to support the requested parameters. If the Logical Unit is unable to perform as requested, it shall generate CHECK CONDITION status and SK/ASC/ASCQ values are set to ILLEGAL REQUEST/ INVALID FIELD IN PARAMETER LIST.

The RA (Random Access) bit, when set to zero, allows the Logical Unit to independently set the read and write speeds. When set to one, directs the Logical Unit to set its performance settings for the optimized settings for random changes between reading and writing by the Initiator. e.g., a CD recorder that is able to record at 2X and read at 6X may choose to limit reading to 2X if the RA bit was set to one.

The Start LBA field is the first logical block for which the performance request is being made.

The End LBA field is the last logical block for which the performance request is being made.

The data rate to be delivered for reading is (Read Size)/(Read Time).

The Read Size field shall indicate the number of kilobytes the Initiator expects to be delivered per period of Read Time when the Initiator's requests for data occur sufficiently fast.

The Read Time field shall indicate the amount of time, in milliseconds, over that the Read Size is expected to be read. The Initiator may set these two fields by setting Read Size to the size of its application's buffer and the Read Time to the amount of time it takes to empty that buffer.

The Write Size field shall be set to the number of kilobytes to be written per Write Time.

The Write Time field shall indicate the amount of time, in milliseconds, over that the Write Size is expected to be written.

In many cases, the Write Size and Write Time fields should be set to match the corresponding Read fields. If not, the Initiator may set the Write Size to the size of its application buffer and the Write Time to the time it takes to fill that buffer.

6.44.3.3 DBI cache zone Descriptor (Type=5)

The DBI cache zone descriptor provides a way for the Initiator to indicate to the logical unit that the application has specific request for logical unit behavior of small DBI cache model in DRT-DM mode. Disc volume space is divided into a few DBI cache zones. RDBI and WDBI memory shall be allocated for each DBI cache zones. At least two DBI cache zones shall be supported. Number of supported DBI cache zone is shown in Number of DBI cache zones field of Table 113 – Enhanced Defect Reporting Feature Descriptor.

Table 552 – DBI cache zone Descriptor

Bit	7	6	5	4	3	2	1	0
Byte								
0-7	DBI cache zone Header							
8-n	DBI cache zone Descriptor(s)							

Table 553 – DBI cache zone Header

Bit	7	6	5	4	3	2	1	0
Byte								
0	(MSB) DBI cache zone Data Length (LSB)							
1								
2								
3								
4-7	Reserved							

The DBI cache zone data length field specifies the length in bytes of the following data. The DBI cache zone data length value does not include the DBI cache zone data length field itself.

Table 554 – DBI cache zone Descriptor(s)

Bit	7	6	5	4	3	2	1	0
Byte								
0	Start LBA of DBI cache zone							
1								
2								
3								
4-7	Reserved							

Start LBA of DBI cache zone field specifies start LBA of a DBI cache zone. Logical unit shall adjust the start LBA to the packet start address that includes specified start LBA by Blocking factor for each media. The end address of a DBI cache zone is the end address of a packet that is preceded to the next DBI cache zone. The end address of the last DBI cache zone is the value of the last addressable LBA for the media. In case of C/DVD-RW media, the last readable address of the last track/Rzone is the end address of the last DBI cache zone.

For C/DVD-RW media, the first DBI cache zone shall be started from 0 and Initiator should set the first cache zone start address to 0. In case of small DBI cache model, Initiator should specify 2 descriptors minimally.

If logical unit received any invalid DBI cache zone descriptor and if number of DBI cache zone descriptors exceeded the value of Number of DBI cache zones field, the logical unit shall terminate this command with CHECK CONDITION status and set sense bytes SK/ASC/ASCQ to ILLEGAL REQUEST/INVALID FIELD IN PARAMETER LIST.

6.44.4 Timeouts

The SET STREAMING command belongs to timeout group 1. If the command is terminated with CHECK CONDITION status due to a timeout, sense bytes SK/ASC/ASCQ shall be set to UNIT ATTENTION/INSUFFICIENT TIME FOR OPERATION.

6.44.5 Error Reporting

Recommended error reporting for the SET STREAMING command is defined in Table 555.

Table 555 – Recommended errors for SET STREAMING Command

Error	Reference
Unit Attention conditions	Table F.1
CDB or parameter list validation errors	Table F.2
Hardware failures	Table F.8

6.45 START STOP UNIT Command

6.45.1 Introduction

The START STOP UNIT command allows the Initiator to request that the MM device be enabled or disabled for media access operations. This command may also be used to control certain power conditions.

Table 556 shows the Features associated with the START STOP UNIT command.

Table 556 – Features Associated with the START STOP UNIT Command

Feature Number	Feature Name	Command Requirement
0003h	Removable Medium	Mandatory
0100h	Power Management	Mandatory

6.45.2 The CDB and Its Parameters

6.45.2.1 The CDB

The START STOP UNIT CDB is shown in Table 557.

Table 557 – START STOP UNIT CDB

Bit	7	6	5	4	3	2	1	0
Byte								
0	Operation Code (1Bh)							
1	Reserved							IMMED
2	Reserved							
3	Reserved							
4	Power Conditions				Reserved		LoEj	Start
5	Control							

6.45.2.2 IMMED

If IMMED (Immediate) is set to zero, status shall be returned only after the operation is completed. If IMMED is set to one, status shall be returned as soon as the CDB has been validated.

6.45.2.3 Power Conditions

The Power Conditions field requests the block device to be placed in the power condition defined in Table 558. If this field has a value other than 0h then the Start and LoEj bits shall be ignored.

Table 558 – Power Conditions

Code	Description
0h	No change in power conditions
1h	Reserved
2h	Place Logical Unit into the Idle State, Standby Timer is reloaded
3h	Place Logical Unit into the Standby State
4h	Reserved
5h	Place Logical Unit into Sleep State. Before entering the sleep state, all buffers shall be successfully flushed by the Logical Unit. If the sleep command is successful, the Initiator should not issue new commands after receiving the successful completion status. The Device shall de-power and disable the interface only after all Logical Units have successful complete sleep commands.
6h – Fh	Reserved

6.45.2.4 LoEj and Start

When Power Conditions field is zero, the meanings of LoEj and Start are defined in Table 559.

Table 559 – LoEj and Start Meanings when Power Conditions = 0

LoEj	Start	Operation
0	0	Stop the disc
0	1	Start the disc and make ready for access
1	0	Eject the disc if permitted. It is not an error If no media is present. See 6.18, PREVENT ALLOW MEDIUM REMOVAL Command
1	1	Load the disc, Start the disc and make ready for access. It is not an error If no media is present.

If the Logical Unit already has the requested state (e.g. Start = 1 and medium is already loaded and ready), the command shall be terminated with GOOD status.

6.45.3 Timeouts

The START STOP UNIT command belongs to timeout group 1. If the command is terminated with CHECK CONDITION status due to a timeout, sense bytes SK/ASC/ASCQ shall be set to UNIT ATTENTION/INSUFFICIENT TIME FOR OPERATION.

6.45.4 Error Reporting

Recommended error reporting for the START STOP UNIT command is defined in Table 560.

Table 560 – Recommended errors for START STOP UNIT Command

Error	Reference	May be Deferred
Unit Attention conditions	Table F.1	
CDB or parameter list validation errors	Table F.2	
General media access errors	Table F.5	√
Hardware failures	Table F.8	√

6.46 STOP PLAY/SCAN Command

6.46.1 Introduction

The STOP PLAY/SCAN command stops playback of CD audio or scan commands.

Table 561 shows the Features associated with the STOP PLAY/SCAN command.

Table 561 – Features Associated with the STOP PLAY/SCAN Command

Feature Number	Feature Name	Command Requirement
0103h	CD Audio External Play	Mandatory

6.46.2 The CDB and Its Parameters

The STOP PLAY/SCAN CDB is shown in Table 562.

Table 562 – STOP PLAY/SCAN CDB

Byte	Bit	7	6	5	4	3	2	1	0
0		Operation Code (4Eh)							
1		Reserved							
2		Reserved							
3		Reserved							
4		Reserved							
5		Reserved							
6		Reserved							
7		Reserved							
8		Reserved							
9		Control							

The STOP PLAY/SCAN command has no parameters. CDB bytes 1 through 8 are reserved and should be zero.

6.46.3 Command Execution

Issuing a Stop Play/Scan command while the Logical Unit is scanning shall result in continuation of the play command. Issuing a Stop Play/Scan command while the Logical Unit is paused shall stop the play command.

Issuing a Stop Play/Scan command when no play operation is in progress shall not be considered an error. Figure 50 provides an overview of the terminate sequences performed by the STOP PLAY command.

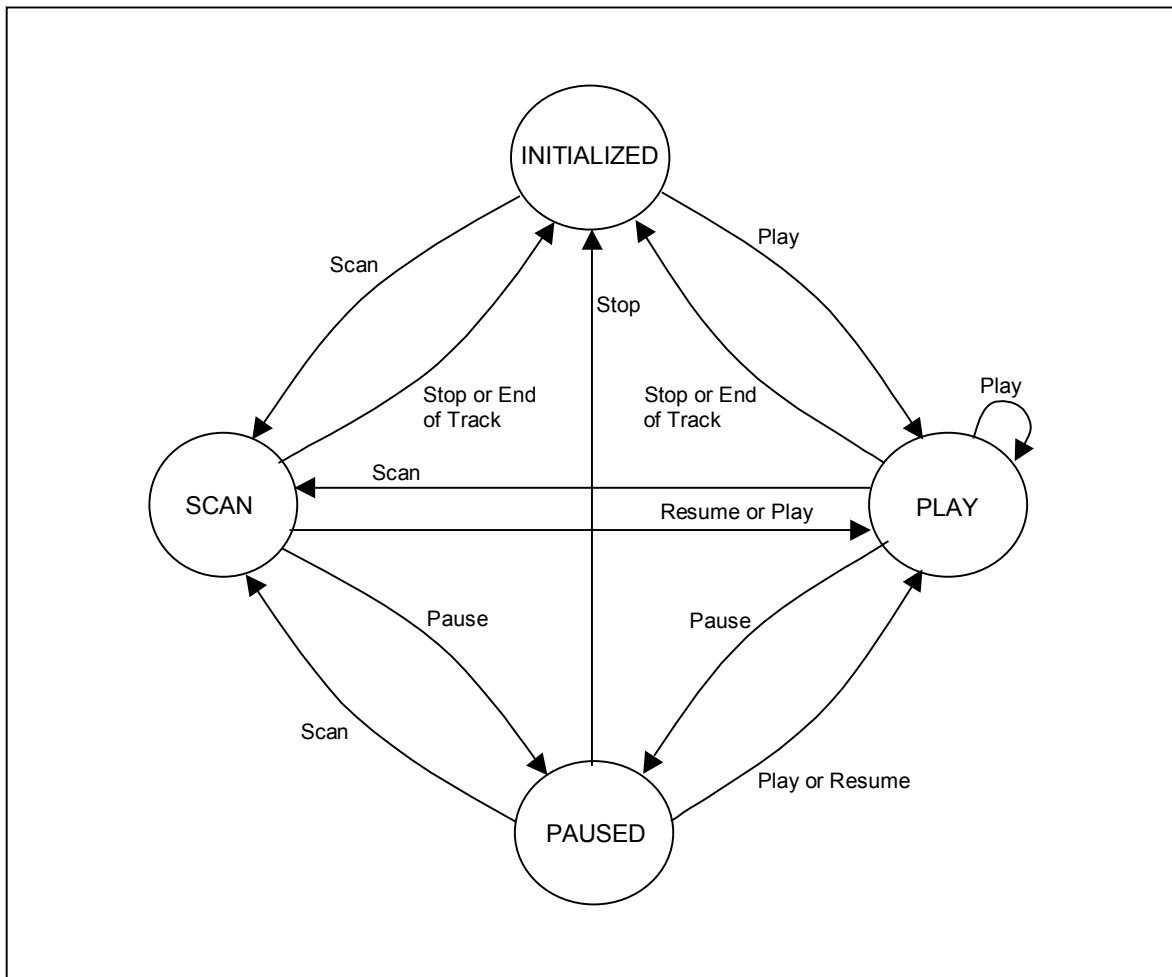

Figure 50 – Stop Play/Play Audio/Audio Scan/Pause/Resume Sequencing

6.46.4 Timeouts

The STOP PLAY/SCAN command belongs to timeout group 1. If the command is terminated with CHECK CONDITION status due to a timeout, sense bytes SK/ASC/ASCQ shall be set to UNIT ATTENTION/INSUFFICIENT TIME FOR OPERATION.

6.46.5 Error Reporting

Recommended error reporting for the STOP PLAY/SCAN command is defined in Table 581.

Table 563 – Recommended errors for STOP PLAY/SCAN Command

Error	Reference
Unit Attention conditions	Table F.1
CDB or parameter list validation errors	Table F.2
General media access errors	Table F.5
Hardware failures	Table F.8

6.47 SYNCHRONIZE CACHE Command

6.47.1 Introduction

The SYNCHRONIZE CACHE command shall ensure that logical blocks in the cache memory have their most recent data value recorded on the physical medium. If a more recent data value for a logical block exists in the cache memory than on the physical medium, then the logical blocks from the cache memory shall be written to the physical medium.

Table 564 shows the Features associated with the SYNCHRONIZE CACHE command.

Table 564 – Features Associated with the SYNCHRONIZE CACHE Command

Feature Number	Feature Name	Command Requirement
0020h	Random Writable	Mandatory
0021h	Incremental Streaming Writable	Mandatory
0025h	Write Once	Mandatory
0026h	Restricted Overwrite	Mandatory
0027h	CD-RW CAV Write	Mandatory
002Bh	DVD+R	Mandatory (when Write bit is set to one)
002Ch	Rigid Restricted Overwrite	Mandatory
002Dh	CD Track At Once	Mandatory
002Eh	CD Mastering (RAW)	Mandatory

6.47.2 The CDB and Its Parameters

6.47.2.1 The CDB

The SYNCHRONIZE CACHE CDB is shown in Table 565.

Table 565 – SYNCHRONIZE CACHE CDB

Bit	7	6	5	4	3	2	1	0
0	Operation Code (35h)							
1	Reserved						IMMED	RelAdr
2	(MSB) Logical Block Address (LSB)							
3								
4								
5								
6								
7	(MSB) Number of Blocks (LSB)							
8								
9	Control							

6.47.2.2 IMMED

If IMMED (Immediate) is set to zero, status shall be returned only after the operation is completed. If IMMED is set to one, status shall be returned as soon as the CDB has been validated.

6.47.2.3 RelAdr

RelAdr (Relative Address) is not used by MM Logical Units and shall be set to zero.

6.47.2.4 Logical Block Address

The Logical Unit may ignore the Logical Block Address field.

6.47.2.5 Number of Blocks

The Logical Unit may ignore the Number of Blocks field.

6.47.3 Command Execution

In streamed write operations, the SYNCHRONIZE CACHE command shall force conditions equivalent to a buffer underrun.

If all data in the cache is synchronized with the media when this command is received, it shall not be considered an error.

6.47.4 Timeouts

The SYNCHRONIZE CACHE command belongs to timeout group 2 when IMMED is zero. The group 2 timeout value is only for Initiator information. The Logical Unit shall not time group 2 timeout commands. Execution shall continue until completion.

When the IMMED is set to one, status shall be returned within a Group 1 timeout.

6.47.5 Error Reporting

Recommended error reporting for the SYNCHRONIZE CACHE command is defined in Table 581.

Table 566 – Recommended errors for SYNCHRONIZE CACHE Command

Error	Reference	May be Deferred
Unit Attention conditions	Table F.1	
CDB or parameter list validation errors	Table F.2	
General media access errors	Table F.5	√
Hardware failures	Table F.8	√

6.48 TEST UNIT READY Command

6.48.1 Introduction

The TEST UNIT READY Command provides a means to check if the Logical Unit is ready. This is not a request for a self-test. The features associated with this command are shown in Table 567.

Table 567 – Features Associated with the TEST UNIT READY Command

Feature Number	Feature Name	Command Requirement
0001h	Core Feature	Mandatory

The TEST UNIT READY command is described in SPC-3.

6.48.2 Timeouts

The TEST UNIT READY command belongs to timeout group 1. If the command is terminated with CHECK CONDITION status due to a timeout, sense bytes SK/ASC/ASCQ shall be set to UNIT ATTENTION/INSUFFICIENT TIME FOR OPERATION.

6.48.3 Error Reporting

Recommended error reporting for the TEST UNIT READY command is defined in Table 581.

Table 568 – Recommended errors for TEST UNIT READY Command

Error	Reference
Unit Attention conditions	Table F.1
CDB or parameter list validation errors	Table F.2
General media access errors	Table F.5
Hardware failures	Table F.8

6.49 VERIFY (10) Command

6.49.1 Introduction

Table 569 shows the Features associated with the VERIFY (10) command.

Table 569 – Features Associated with the VERIFY (10) Command

Feature Number	Feature Name	Command Requirement
0022h	Sector Erasable	Mandatory
0023h	Formattable	Mandatory
0028h	MRW	Mandatory
002Ch	Rigid Restricted Overwrite	Mandatory

6.49.2 The CDB and Its Parameters

6.49.2.1 The CDB

The VERIFY (10) CDB is shown in Table 570.

Table 570 – VERIFY (10) CDB

Bit	7	6	5	4	3	2	1	0	
Byte									
0	Operation Code (2Fh)								
1	Reserved			DPO	Reserved		BytChk	RelAdr	
2	Logical Block Address								
3									(MSB)
4									
5									
6	G3tout	Reserved							
7	Number of Blocks								
8									(MSB)
								(LSB)	
9	Control								

6.49.2.2 DPO

Disable Page Out (DPO) is not used by MM Logical Units and shall be set to zero.

6.49.2.3 BytChk

BytChk (Byte Check) is not used by MM Logical Units and shall be set to zero.

6.49.2.4 RelAdr

RelAdr (Relative Address) is not used by MM Logical Units and shall be set to zero.

6.49.2.5 Logical Block Address

Logical Block Address references the block at which the operation shall begin.

6.49.2.6 Number of Blocks

Number of Blocks specifies the number of contiguous logical blocks of data or blanks that shall be verified. If Number of Blocks is zero indicates that no logical blocks shall be verified. This condition shall not be considered as an error. Any other value indicates the number of logical blocks that shall be verified.

6.49.2.7 G3tout

If the G3tout bit is set to 1 and if the logical unit supports Group3 timeout and if Restricted Overwrite Feature or Rigid Restricted Overwrite Feature (e.g., CD-RW, DVD-RW) is current and if the

G3Enable bit in Timeout & Protect Mode Page (1Dh) is set to 1, the logical unit shall terminate this command within Group 3 timeout. In other cases, this command is categorized as Group 2 timeout.

6.49.3 Command Execution

Verify Error Recovery Mode Page parameters are not supported by MM Logical Units. The Logical Unit shall utilize the Read/Write Error Recovery Mode Page as verify parameters. For Writable device-media systems with defect management, the ARRE bit shall control automatic reallocation.

If the currently mounted medium is DVD-RAM, the verify operation of this command shall use stricter criteria for data recoverability than is used by read commands. The criteria are derived from the DVD-RAM Book, with additional vendor specific criteria allowed.

If the currently mounted medium is CD-RW with MRW formatting operating in background, DVD+RW with basic formatting operating in background, or DVD+RW with MRW formatting operating in background, the VERIFY command operation shall be as follows:

- If any of the sectors within the range specified by the CDB are in a blank area of the media where format writing has not yet occurred, the blank sectors shall not be read and the command shall operate as if the sectors had been verified as good.
- If all of the sectors within the range specified by the CDB are in an area of the media where format writing has occurred, the command shall operate normally.

If Enhanced Defect Reporting Feature is current, the logical unit shall follow the setting of the PER bit and the EMCDR field in Read/Write Error Recovery Parameters Mode Page (01h). See clause 4.6, "Logical unit assisted software defect management model".

6.49.4 Timeouts

The VERIFY (10) command belongs to timeout group 2. The group 2 timeout value is only for Initiator information. The Logical Unit shall not time group 2 timeout commands. Execution shall continue until completion.

If the logical unit supports Group3 time-out and the G3Enable bit in Time-out & Protect Mode Page (1Dh) is set to 1, VERIFY (10) is re-categorized as Group 3 time-out. Refer to 4.1.8.5.

6.49.5 Error Reporting

Recommended error reporting for the VERIFY (10) command is defined in Table 571.

Table 571 – Recommended errors for VERIFY (10) Command

Error	Reference	May be Deferred
Unit Attention conditions	Table F.1	
CDB or parameter list validation errors	Table F.2	
General media access errors	Table F.5	
Hardware failures	Table F.8	

6.50 WRITE (10) Command

6.50.1 Introduction

The WRITE (10) Command requests that the Logical Unit write Initiator data to the medium. In order to achieve correct operation, the Logical Unit may require information from the Write Parameters Mode Page.

Table 572 shows the Features associated with the WRITE (10) command.

Table 572 – Features Associated with the WRITE (10) Command

Feature Number	Feature Name	Command Requirement
0020h	Random Writable	Mandatory
0021h	Incremental Streaming Writable	Mandatory
0022h	Sector Erasable	Mandatory
0025h	Write Once	Mandatory
0026h	Restricted Overwrite	Mandatory
0027h	CD-RW CAV Overwrite	Mandatory
0028h	MRW	Mandatory (when Write bit is set)
002Ah	DVD+RW	Mandatory (when Write bit is set)
002Bh	DVD+R	Mandatory (when Write bit is set)
002Ch	Rigid Restricted Overwrite	Mandatory
002Dh	CD Track At Once	Mandatory
002Eh	CD Mastering (both SAO and RAW)	Mandatory
002Fh	DVD-R/-RW	Mandatory
0031h	DDCD-R Write	Mandatory
0032h	DDCD-RW Write	Mandatory

6.50.2 The CDB and Its Parameters

6.50.2.1 The CDB

The WRITE (10) CDB is shown in Table 573.

Table 573 – WRITE (10) CDB

Bit	7	6	5	4	3	2	1	0
0	Operation Code (2Ah)							
1	Reserved			DPO	FUA	Reserved		RelAdr
2	(MSB) Logical Block Address (LSB)							
3								
4								
5								
6								
7	(MSB) Transfer Length (LSB)							
8								
9	Control							

6.50.2.2 DPO

Disable Page Out (DPO) is not used by MM Logical Units and shall be set to zero.

6.50.2.3 FUA

A FUA (force unit access) bit, set to one, indicates that the Logical Unit shall access the media in

performing the command prior to returning GOOD status. In the case where the cache contains a more recent version of a logical block than the media, the logical block shall first be written to the media. WRITE commands shall not return GOOD status until the logical blocks have actually been written on the media, and the Write process is complete. This mode may not operate correctly with a sequence of writes intended to produce a continuous stream unless command queuing is implemented

A FUA bit of zero indicates that the Logical Unit may satisfy the command by accessing the cache memory. For WRITE operations, logical blocks may be transferred directly to the cache memory. GOOD status may be returned to the Initiator prior to writing the logical blocks to the medium. Any error that occurs after the GOOD status is returned is a deferred error, and information regarding the error is not reported until the following command.

6.50.2.4 RelAdr

RelAdr (Relative Address) is not used by MM Logical Units and shall be set to zero.

6.50.2.5 Logical Block Address

The Logical Block Address field specifies the logical block where the write operation shall begin. If Starting Logical Block Address is not within the range specified by the READ CAPACITY command response, the command shall be terminated with CHECK CONDITION status and sense bytes SK/ASC/ASCQ shall be set to ILLEGAL REQUEST/LOGICAL BLOCK ADDRESS OUT OF RANGE. When the Random Writable Feature is not current, valid Logical Block Addresses may be further restricted. In such cases, if the Starting Logical Block Address is not valid, the command shall be terminated with CHECK CONDITION status and sense bytes SK/ASC/ASCQ shall be set to ILLEGAL REQUEST/INVALID ADDRESS FOR WRITE. For DDCD and all DVD media, the write block size is 2048 bytes. The Write Parameters Mode Page shall determine the write block size for writable CD media.

6.50.2.6 Transfer Length

The Transfer Length specifies the number of contiguous logical blocks of data that shall be transferred. A Transfer Length of zero indicates that no data shall be transferred. This condition shall not be considered an error and no data shall be written.

6.50.3 Command Execution

6.50.3.1 General

If the Logical Unit is unable to write to the currently mounted medium, error reporting should follow the guidelines according to 4.1.6.3.

6.50.3.2 CD-R Fixed Packet, Variable Packet, Track-At-Once

The Logical Block Address shall be valid within the range 0 through MAXLBA where MAXLBA is the address limit reported by the READ CAPACITY command.

For each track on the disc in which the Track Information reports a valid Next Writable Address, the starting LBA shall be one of the Next Writable Addresses.

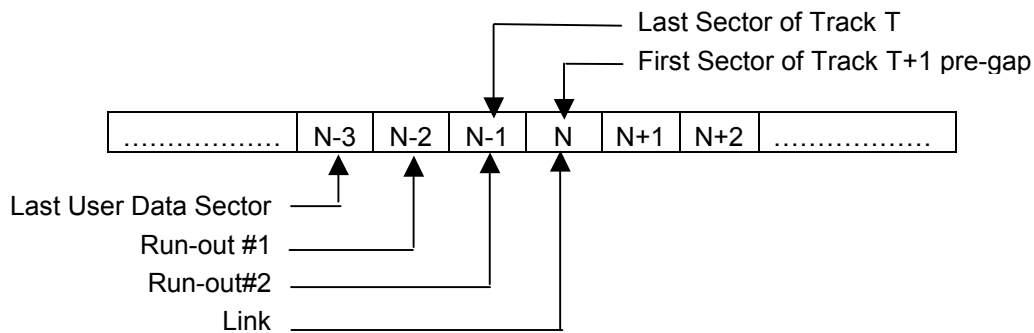

If the Starting LBA plus the Transfer Length minus 3 is greater than the remaining blank space of the

track, the data shall be written until the end of track is encountered

6.50.3.3 SAO Raw on CD-R/-RW, DAO and Incremental on DVD-R/-RW

Session-At-Once Raw recording begins in the disc lead-in. LBAs in the range of -45 150 (FFFF4FA2h) to -1 (FFFFFFFFh) shall be encoded as a two's complement negative number. Values in the range 0 through FFFF4FA1h shall be considered positive values.

Table 574 shows the LBA to MSF mapping.

For CD-R/RW media, the block size shall be determined by the Write Parameters Page (if in track at once, packet, or raw mode) or by the cue sheet (session at once mode).

If the medium is MRW formatted or in progress with MRW formatting, then the block size shall be 2 048 bytes. The Logical Block Address shall be valid within the range 0 through MAXLBA where MAXLBA is the address reported by the READ CAPACITY command.

Table 574 – LBA to MSF translation

Condition	Formulae
$-150 \leq LBA \leq 404849$	$M = IP \left(\frac{LBA + 150}{60 \cdot 75} \right)$ $S = IP \left(\frac{LBA + 150 - M \cdot 60 \cdot 75}{75} \right)$ $F = IP(LBA + 150 - M \cdot 60 \cdot 75 - S \cdot 75)$
$-45150 \leq LBA \leq -151$	$M = IP \left(\frac{LBA + 450150}{60 \cdot 75} \right)$ $S = IP \left(\frac{LBA + 450150 - M \cdot 60 \cdot 75}{75} \right)$ $F = IP(LBA + 450150 - M \cdot 60 \cdot 75 - S \cdot 75)$
$00:00:00 \leq MSF \leq 89:59:74$	$LBA = (M \cdot 60 + S) \cdot 75 + F - 150$
$90:00:00 \leq MSF \leq 99:59:74$	$LBA = (M \cdot 60 + S) \cdot 75 + F - 450150$

For CD-R and DVD-R, once actual writing to the media has started, the data stream shall be uninterrupted until the recording is done. Interruptions of data are called “under-run.” The under-run condition may also be forced with the SYNCHRONIZE CACHE command. The Logical Unit shall behave as follows in an under-run condition.

1. Session at Once mode (Disc at Once mode for DVD): The Logical Unit shall generate and write a Lead-out (the Lead-in was generated and written before any data). The Logical Unit shall update the PMA (CD) or RMA (DVD).
2. Track at Once mode: The Logical Unit shall pad the track (if reserved or not minimum length) and update the PMA (CD).
3. Variable Packet (Incremental mode of DVD): For CD, if insufficient space exists for another variable packet within a reserved track, the Logical Unit shall pad the packet such that it fills the track. Otherwise, the Logical Unit shall write run-out and link blocks. For DVD the Logical Unit shall perform linking.
4. Fixed Packet (Restricted Overwrite mode CD-RW): The Logical Unit shall pad the packet.
5. Raw mode: The Logical Unit shall write run-out and link blocks. The Logical Unit shall read the TOC and track information from the session just written and update the PMA. It is assumed that the Initiator has written the Lead-out.

6. Rigid Restricted Overwrite mode (DVD-RW): The start address and the end address of a write command shall be ECC block boundary. If the address is not ECC block boundary, the Logical Unit shall return a CHECK CONDITION status and SK/ASC/ASCQ values are set to ILLEGAL REQUEST/INVALID ADDRESS FOR WRITE.

If the block number specified by the LBA field is already written on CD-R media, the Logical Unit shall return a CHECK CONDITION status and SK/ASC/ASCQ values are set to ILLEGAL REQUEST/INVALID ADDRESS FOR WRITE. This error indicates that an under-run may have occurred, as the run-out and link blocks occupy logical addresses. On CD-RW media, the LBA shall specify an address that is an appendable point (according to CD-R rules) or is the first user data block of an existing packet or track.

While writing is occurring, the Logical Unit may not be able to process all SCSI commands. The following is a list of commands that shall function during writing without causing a SYNCHRONIZE CACHE.

1. TEST UNIT READY
2. REQUEST SENSE
3. INQUIRY
4. READ TRACK INFO (for current track). If the LBA or track number specified is not within the current track, the Logical Unit may return CHECK CONDITION status and SK/ASC/ASCQ values are set to ILLEGAL REQUEST/INVALID FIELD IN CDB.
5. READ BUFFER CAPACITY
6. WRITE with the NWA in the current track.
7. GET CONFIGURATION
8. GET EVENT STATUS NOTIFICATION

All other commands shall process normally, but may force a SYNCHRONIZE CACHE before executing. The process of writing from the Logical Unit's cache to the medium shall not cause a not ready condition for any command. When the Logical Unit is padding a reserved track or writing Lead-in and Lead-out, a WRITE command may be terminated with CHECK CONDITION status with SK/ASC/ASCQ values set to LOGICAL UNIT NOT READY, LONG WRITE IN PROGRESS.

When Restricted Overwrite method is currently performed (Restricted Overwrite Feature (0026h) or Rigid Restricted Overwrite Feature (002Ch)), READ (10) command or READ (12) command shall be performed normally after data in buffer is written on the disc.

In case of DRT-DM mode, when Enhanced Defect Reporting Feature (0029h) is current and when the EMCDR field is set to 2 or 3, and if a Type 1, Type 2, or Type 3 defect level is found in DBI memory for any of the blocks being written, the logical unit shall terminate the command with CHECK CONDITION status and sense bytes SK/ASC/ASCQ shall be set to RECOVERED ERROR/RECOVERED DATA – RECOMMEND REASSIGNMENT at the completion of the command. Type 4 defect shall be stored in DBI memory. Data in buffer shall be written on the medium normally.

6.50.3.4 DVD-RAM

Since DVD-RAM has the Random Writable Feature, there are no special considerations for address translations or loss of streaming.

6.50.3.5 DVD+R

DVD+R shall be recorded sequentially from any valid NWA. Unlike CD-R, DVD+R has zero loss linking. There are no special considerations or loss of streaming.

6.50.3.6 DVD+RW

Since DVD+RW has the Random Writable Feature, there are no special considerations for address translations or loss of streaming.

6.50.4 Timeouts

The WRITE (10) command belongs to timeout group 1. If the command is terminated with CHECK CONDITION status due to a timeout, sense bytes SK/ASC/ASCQ shall be set to NOT READY/

INSUFFICIENT TIME FOR OPERATION. When the FUA bit in the CDB is set to zero, and the WCE bit in the Cacheing Page is set to one timeouts are permitted only as deferred errors.

6.50.5 Error Reporting

Recommended error reporting for the WRITE (10) command is defined in Table 575.

Table 575 – Recommended errors for WRITE (10) Command

Error	Reference	May be Deferred
Unit Attention conditions	Table F.1	
CDB or parameter list validation errors	Table F.2	
General media access errors	Table F.5	√
Errors Associated with writing	Table F.7	√
Hardware failures	Table F.8	√

6.51 WRITE (12) Command

6.51.1 Introduction

The WRITE (12) command requests that the Logical Unit write Initiator data to the medium. In order to achieve correct operation, the Logical Unit may require information from the Write Parameters Mode Page.

Table 576 shows the Features associated with the WRITE (12) command.

Table 576 – Features Associated with the WRITE (12) Command

Feature Number	Feature Name	Command Requirement
002Ah	DVD+RW	Mandatory (when Write bit is set to one)
0032h	DDCD-RW Write	Mandatory
0031h	DDCD-R Write	Mandatory
0032h	DDCD-RW Write	Mandatory
0107h	Real-time Streaming	Mandatory

6.51.2 The CDB and Its Parameters

6.51.2.1 The CDB

The WRITE (12) CDB is shown in Table 577.

Table 577 – WRITE (12) CDB

Bit	7	6	5	4	3	2	1	0
0	Operation Code (AAh)							
1	Reserved			FUA		Reserved		
2	(MSB) Logical Block Address (LSB)							
3								
4								
5								
6	(MSB) Transfer Length (LSB)							
7								
8								
9								
10	Streaming	Reserved						
11	Control							

6.51.2.2 FUA

A FUA (Force Unit Access) bit, set to one, indicates that the Logical Unit shall access the media in performing the command prior to returning GOOD status. In the case where the cache contains a more recent version of a logical block than the media, the logical block shall first be written to the media. WRITE commands shall not return GOOD status until the logical blocks have actually been written on the media, and the Write process is complete. This mode may not operate correctly with a sequence of writes intended to produce a continuous stream unless command queuing is implemented.

A FUA bit of zero indicates that the Logical Unit may satisfy the command by accessing the cache memory. For WRITE operations, logical blocks may be transferred directly to the cache memory. GOOD status may be returned to the Initiator prior to writing the logical blocks to the medium. Any error that occurs after the GOOD status is returned is a deferred error, and information regarding the error is not reported until the following command.

6.51.2.3 Logical Block Address

The Logical Block Address field specifies the logical block where the write operation shall begin. If Starting Logical Block Address is not within the range specified by the READ CAPACITY command response, the command shall be terminated with CHECK CONDITION status and sense bytes SK/ASC/ASCQ shall be set to ILLEGAL REQUEST/LOGICAL BLOCK ADDRESS OUT OF RANGE. When the Random Writable Feature is not current, valid Logical Block Addresses may be further restricted. In such cases, if the Starting Logical Block Address is not valid, the command shall be terminated with CHECK CONDITION status and sense bytes SK/ASC/ASCQ shall be set to ILLEGAL REQUEST/INVALID ADDRESS FOR WRITE. For DDCD and all DVD media, the write block size is 2048 bytes. The Write Parameters Mode Page shall determine the write block size for writable CD media.

6.51.2.4 Transfer Length

The Transfer Length specifies the number of contiguous logical blocks of data that shall be transferred. A Transfer Length of zero indicates that no data shall be transferred. This condition shall not be considered an error and no data shall be written.

6.51.2.5 Blocking Factor

The Starting LBA and the Transfer Length identify a logical track into which the data is to be written. The Track Information for that logical track identifies a Blocking Factor. When the Initiator issues the command with the Streaming bit set to one, the values of the Starting Logical Block Address and the Transfer Length fields shall each be an integral multiple of the Blocking factor. If either the Starting Logical Block Address field or the Transfer Length field is not set to an integral multiple of the Blocking Factor, the command shall be terminated with CHECK CONDITION status and sense bytes SK/ASC/ASCQ shall be set to ILLEGAL REQUEST/INVALID FIELD IN CDB.

6.51.2.6 Streaming

If the Streaming bit is zero, the write operation shall be according to the WRITE (10) command. If the Streaming bit is one, Stream recording operation shall be used for the command.

If the Streaming bit is set to 1 and if the logical unit supports Group3 timeout and if G3Enable bit in Timeout & Protect Mode Page (1Dh) is set to 1, the logical unit shall terminate this command within Group 3 timeout. If the G3Enable bit is set to 0, this command is categorized as Group 1 timeout.

When the Streaming bit is set to one, the FUA bit shall be set to zero. If both the Streaming bit and the FUA bit are set to one, the command shall be terminated with CHECK CONDITION status with SK/ASC/ASCQ values set to ILLEGAL REQUEST/INVALID FIELD IN CDB.

If the Streaming bit is set to one and the Caching Page is supported, the WCE (Write Cache Enable) bit in the Caching Page shall be set to one. If the Streaming bit is set to one and WCE is zero, the command shall be terminated with CHECK CONDITION status with SK/ASC/ASCQ values set to ILLEGAL REQUEST/INVALID FIELD IN CDB.

6.51.3 Command Execution

If the Logical Unit is unable to write to the currently mounted medium, error reporting should follow the guidelines according to 4.1.6.3.

For the DVD-RAM Ver.2.1, the Logical Unit shall set to one all Recording Type bits that are in the Data ID fields of all sectors within the ECC Block to be written, when WRITE (12) command with the Streaming bit set to one is issued by the Initiator. The Logical Unit shall set all the Recording Type bits to zero when WRITE (12) command with the Streaming bit set to zero is issued by the Initiator.

If the media is DVD+RW and is blank (never formatted), then a write to any address shall be terminated with CHECK CONDITION status and SK/ASC/ASCQ values shall be set to ILLEGAL REQUEST/MEDIUM NOT FORMATTED.

6.51.4 Timeouts

The WRITE (12) command belongs to timeout group 1. If the command is terminated with CHECK CONDITION status due to a timeout, sense bytes SK/ASC/ASCQ shall be set to NOT READY/INSUFFICIENT TIME FOR OPERATION. When the FUA bit in the CDB is set to zero, and the WCE

bit in the Cacheing Page is set to one timeouts are permitted only as deferred errors.

If the logical unit supports Group3 time-out and the G3Enable bit in Time-out & Protect Mode Page (1Dh) is set to 1, WRITE (12) with Streaming = 1 is re-categorized as Group 3 time-out. Refer to 4.1.8.5.

6.51.5 Error Reporting

Recommended error reporting for the WRITE (12) command is defined in Table 578.

Table 578 – Recommended errors for WRITE (12) Command

Error	Reference	May be Deferred
Unit Attention conditions	Table F.1	
CDB or parameter list validation errors	Table F.2	
General media access errors	Table F.5	√
Errors Associated with writing	Table F.7	√
Hardware failures	Table F.8	√

6.52 WRITE AND VERIFY (10) Command

6.52.1 Introduction

The WRITE AND VERIFY (10) command requests that the Logical Unit write the data transferred from the Initiator to the medium and then verify that the data is correctly written.

Table 579 shows the Features associated with the WRITE AND VERIFY (10) command.

Table 579 – Features Associated with the WRITE AND VERIFY (10) Command

Feature Number	Feature Name	Command Requirement
0020h	Random Writable	Mandatory
0025h	Write Once	Mandatory
0028h	MRW	Mandatory (when Write bit is set to one)
002Ah	DVD+RW	Mandatory (when Write bit is set to one)

6.52.2 The CDB and Its Parameters

6.52.2.1 The CDB

The WRITE AND VERIFY (10) CDB is shown in Table 580.

Table 580 – WRITE AND VERIFY (10) CDB

Bit	7	6	5	4	3	2	1	0
Byte								
0	Operation Code (2Eh)							
1	Reserved							
2	Starting Logical Block Address							
3								
4								
5								
6								
7	Reserved							
8	Transfer Length							
9	(LSB)							
	Control							

6.52.2.2 Starting Logical Block Address

Starting Logical Block Address references the block at which the operation shall begin.

6.52.2.3 Transfer Length

Transfer length specifies the number of contiguous logical blocks of data or blanks that shall be written and verified. A transfer length of zero indicates that no logical blocks shall be verified. This condition shall not be considered as an error. Any other value indicates the number of logical blocks that shall be verified.

6.52.3 Command Execution

If the Logical Unit is unable to write to the currently mounted medium, error reporting should follow the guidelines according to 4.1.6.3.

Writing shall be according to the description of the WRITE (10) command with the FUA bit is set to one.

Verify Error Recovery Mode Page parameters are not supported by MM Logical Units. The Logical Unit shall utilize the Read/Write Error Recovery Mode Page as verify parameters. The AWRE and ARRE bits shall control automatic reallocation.

If Enhanced Defect Reporting Feature (0029h) is current, the logical unit shall follow the setting of the

PER bit and the EMCDR field in Read/Write Error Recovery Parameters Mode Page (01h). See Clause 4.6, "Logical unit assisted software defect management model".

If the currently mounted medium is DVD-RAM, the verify operation of this command shall use stricter criteria for data recoverability than is used by read commands. The criteria are derived from the DVD-RAM Book, with additional vendor specific criteria allowed.

If the currently mounted medium is DVD-RAM Ver.2.1, the Logical Unit shall set to zero all Recording Type bits that are in the Data ID fields of all sectors within the ECC Block to be written.

If the currently mounted medium is DVD+RW and the medium is blank (never formatted), then a write to any address shall be terminated with CHECK CONDITION status and SK/ASC/ASCQ values shall be set to ILLEGAL REQUEST/MEDIUM NOT FORMATTED.

6.52.4 Timeouts

The WRITE AND VERIFY (10) command belongs to timeout group 2. The group-2 timeout value is only for Initiator information. The Logical Unit shall not time group 2 timeout commands. Execution shall continue until completion.

6.52.5 Error Reporting

Recommended error reporting for the WRITE AND VERIFY (10) command is defined in Table 581.

Table 581 – Recommended errors for WRITE AND VERIFY (10) Command

Error	Reference	May be Deferred
Unit Attention conditions	Table F.1	
CDB or parameter list validation errors	Table F.2	
General media access errors	Table F.5	√
Hardware failures	Table F.8	√

6.53 WRITE BUFFER Command

6.53.1 Introduction

The WRITE BUFFER Command is used in conjunction with the READ BUFFER Command as a diagnostic function for testing Logical Unit memory in the target device and the integrity of the service delivery subsystem. Additional modes are provided for downloading/saving microcode. This command shall not alter any medium of the Logical Unit when the data mode or the combined header and data mode is specified.

The features associated with this command are shown in Table 582.

Table 582 – Features Associated with the WRITE BUFFER Command

Feature Number	Feature Name	Command Requirement
0104h	Microcode Upgrade	Mode 111b is Mandatory

The WRITE BUFFER command is described in SPC-3.

6.53.2 Timeouts

The WRITE BUFFER command belongs to timeout group 1. If the command is terminated with CHECK CONDITION status due to a timeout, sense bytes SK/ASC/ASCQ shall be set to UNIT ATTENTION/INSUFFICIENT TIME FOR OPERATION.

6.53.3 Error Reporting

Table 583 describes errors that may occur during the operation of the Command or that may cause a CHECK CONDITION status to be reported.

Table 583 – WRITE BUFFER Command Errors

Error	Reference
Unit Attention conditions	Table F.1
CDB or parameter list validation errors	Table F.2
Hardware failures	Table F.8

7 Mode Parameters for Multi-Media Devices

7.1 Structure Formats

7.1.1 Mode Parameter List

A mode parameter list shall be transferred from the logical unit to the Initiator during the execution of the MODE SENSE (10) command.

A mode parameter list shall be transferred from the Initiator to the logical unit during the execution of the MODE SELECT (10) command.

The mode parameter list (Table 584) contains a header followed by zero or more variable-length mode pages.

Table 584 – Mode Parameter List

Bit	7	6	5	4	3	2	1	0
Byte								
0 – 7	Mode Parameter Header							
8 – n	Mode Page(s)							

7.1.2 Mode Parameter Header Format

The Mode Parameters Header (Table 585) contains information about subsequent mode parameter data.

Table 585 – Mode Parameters Header

Bit	7	6	5	4	3	2	1	0
Byte								
0	(MSB) Mode Data Length (LSB)							
1								
2	Reserved							
3	Reserved							
4	Reserved							
5	Reserved							
6	(MSB) Block Descriptor Length = 0 (LSB)							
7								

When returned by the MODE SENSE (10) command, the Mode Data Length field is the length in bytes of available data that follows the Mode Data Length field. The Mode Data Length does not include the number of bytes in the Mode Data Length field.

When transferred during execution of the MODE SELECT (10) command, Mode Data Length is reserved.

7.1.3 Mode Pages

Mode Pages are used to provide parametric information from the Logical Unit to the Initiator or from the Initiator to the Logical Unit. Table 586 shows the mode pages available for use by Multi-media Logical Units.

Table 586 – Mode Pages for MM Logical Units

Page Code	Description	Reference
00h	Vendor-specific (does not require mode page format)	-
01h	Read/Write Error Recovery mode page	7.2
02h	Reserved	-
03h	MRW mode page	7.3
04h	Reserved	-
05h	Write Parameter mode page	7.4
06h	Reserved	-
07h	Verify Error Recovery mode page	SBC (Not permitted for MM LUs)
08h	Caching mode page	7.5
08h – 0Ah	Reserved	-
0Bh	Medium types supported mode page	SBC (Not permitted for MM LUs)
0Ch	Reserved	-
0Dh	CD Device Parameters mode page	E.3.2
0Eh	CD Audio Control mode page	7.6
0Fh – 19h	Reserved	-
1Ah	Power Condition mode page	7.7
1Bh	Reserved	-
1Ch	Fault/Failure Reporting	7.8
1Dh	Time-out & Protect mode page	7.9
1Eh – 1Fh	Reserved	-
20h – 29h	Vendor Specific	-
2Ah	MM Capabilities & Mechanical Status mode page	E.3.3
2Bh	Reserved	-
2Dh – 3Eh	Vendor Specific	-
3Fh	Return all pages (valid only for the Mode Sense command)	-

7.1.4 Mode Page Format

The general format of a mode page is shown in Table 587.

Table 587 – Mode Page Format

Bit	7	6	5	4	3	2	1	0
Byte								
0	PS/ Reserved	Reserved	Page Code					
1	Page Length (n – 1)							
2	Mode Parameters							
...								
N								

7.1.4.1 Parameters Savable bit (PS)

7.1.4.1.1 PS in the MODE SENSE Returned Data

When Parameters Savable (PS) bit is zero (0), the Logical Unit does not support saving this mode page data.

7.1.4.1.2 PS in the MODE SELECT Parameter List

When using the MODE SELECT (10) command, the PS bit is reserved.

7.1.4.2 Page Code

The Page Code field identifies the format and parameters defined for the mode page.

7.1.4.2.1 Page Code in the MODE SENSE Returned Data

If the Logical Unit implements Mode Page 00h (a vendor specific page) and the MODE SENSE (10) command is received with Page Code (CDB parameter) set to 3Fh (return all pages), then Mode Page 00h shall appear last in the returned data.

7.1.4.2.2 Page Code in the MODE SELECT Parameter List

The Initiator may specify a Page Code from any of the pages in Table 586. If the Logical Unit does not support the page specified by the Page Code, then the command shall be terminated with CHECK CONDITION status and SK/ASC/ASCQ shall be set to ILLEGAL REQUEST/INVALID FIELD IN PARAMETER LIST.

7.1.4.3 Page Length

The Page Length field specifies the length in bytes of the mode parameters that follow.

7.1.4.3.1 Page Length in the MODE SENSE Returned Data

The Logical Unit is permitted to implement a mode page that is less than the full-page length, provided no field is truncated and the Page Length field correctly specifies the actual length implemented.

7.1.4.3.2 Page Length in the MODE SELECT Parameter List

If the Initiator does not set this value to the value that is returned for the page by the MODE SENSE command, the Logical Unit shall terminate the command with CHECK CONDITION status and SK/ASC/ASCQ values shall be set to ILLEGAL REQUEST/INVALID FIELD IN PARAMETER LIST.

7.2 Read/Write Error Recovery Parameters Mode Page (Page Code 01h)

7.2.1 Introduction

The Read/Write Error Recovery Parameters Mode Page (Table 589) specifies the error recovery parameters the Logical Unit shall use during any command that performs a data read or write operation from the media (e.g. READ, READ CD, WRITE, etc.).

Table 588 shows the Features associated with the Read/Write Error Recovery Mode Page.

Table 588 – Features Associated with the READ/WRITE Error Recovery Mode Page

Feature Number	Feature Name	Requirement
0010h	Random Readable	Mandatory when PP bit is 1.
0020h	Random Writable	Mandatory when PP bit is 1.
0024h	Hardware Defect Management	Mandatory
0025h	Write Once	Mandatory when PP bit is 1.
0029h	Enhanced Defect Reporting	Mandatory

7.2.2 The Mode Page and its Parameters

7.2.2.1 The Mode Page

Table 589 – Read/Write Error Recovery Parameters Mode Page Format

Bit	7	6	5	4	3	2	1	0
0	PS	Reserved	Page Code (01h)					
1	Page Length (0Ah)							
2	Error Recovery Behavior							
	AWRE	ARRE	TB	RC	Reserved	PER	DTE	DCR
3	Read Retry Count							
4	Reserved							
5	Reserved							
6	Reserved							
7	Reserved						EMCDR	
8	Write Retry Count							
9	Reserved							
10	Reserved							
11	Reserved							

7.2.2.2 PS

The Parameters Savable (PS) bit is defined in 7.1.4.1.

7.2.2.3 Page Code

The Page Code field shall be set to 01h, identifying the Read/Write Error Recovery Parameters Mode Page.

7.2.2.4 Page Length

The Page Length shall be set to 0Ah.

7.2.2.5 Error Recovery Behavior

7.2.2.5.1 Automatic Write Reallocation Enabled (AWRE)

The Automatic Write Reallocation Enabled bit (AWRE) shall be ignored when the Current bit of the Defect Management Feature descriptor is set to zero.

If AWRE is set to one, the Logical Unit shall enable automatic reallocation of defective blocks during write operations. If AWRE bit is set to zero, the Logical Unit shall not perform automatic reallocation of defective data blocks during write operations. If the media format is MRW, the default value for AWRE is one (1b). Error reporting as required by the error recovery bits (EER, PER, DTE, and DCR) shall be performed only after completion of the reallocation.

The Automatic Read Reallocation Enabled bit (ARRE) shall be ignored when the Current bit of the Defect Management Feature descriptor is set to zero.

7.2.2.5.2 Automatic Read Reallocation Enabled (ARRE)

If the Automatic Read Reallocation Enabled bit (ARRE) is set to one, the Logical Unit shall enable automatic reallocation of defective data blocks during read operations. If ARRE is set to zero, the Logical Unit shall not perform automatic reallocation of defective data blocks during read operations. All error recovery actions required by the error recovery bits (TB, EER, PER, DTE, and DCR) shall be processed. The automatic reallocation shall then be performed only if the Logical Unit successfully recovers the data. Error reporting as required by the error recovery bits shall be performed only after completion of the reallocation. The reallocation process shall present any failures that occur. When ARRE is set to one, DCR and RC shall be each set to zero. When media formatted as MRW is detected, the value of ARRE shall default to zero. When DVD+RW media with the Basic Format is detected, ARRE and AWRE shall default to zero and is unable to be set to one by the Initiator.

7.2.2.5.3 Transfer Block (TB)

A transfer block (TB) bit of zero indicates that a data block that has not been successfully recovered shall not be transferred to the Initiator. A TB bit of one indicates that a data block that is not recovered within the recovery limits specified shall be transferred to the Initiator before CHECK CONDITION status is returned. The TB bit does not affect the action taken for recovered data.

7.2.2.5.4 Read Continuous (RC)

A Read Continuous (RC) bit of zero indicates that error recovery operations that cause delays are acceptable during the data transfer. The Logical Unit shall assign priority to this bit over conflicting error control bits (EER, DCR, DTE, and PER) within this byte.

A RC bit of one indicates the Logical Unit shall transfer the entire requested length of data without adding delays to perform error recovery procedures. This implies that the Logical Unit may send data that is erroneous or fabricated in order to maintain a continuous flow of data. Fabricated data may be data already in the buffer or any other vendor-specific data. This bit may be used in image processing, audio, or video applications. A read continuous (RC) bit of zero indicates that error recovery operations that cause delays are acceptable during the data transfer.

7.2.2.5.5 Post Error (PER)

A Post Error (PER) bit controls recovered error reporting of logical unit. This bit is used in conjunction with the EMCDR field if logical unit supports Enhanced Defect Reporting Feature. The description of this bit is described in 7.2.2.7.1, "Description of PER bit and EMCDR field".

A Post Error (PER) bit of one indicates that the Logical Unit shall report recovered errors. A PER bit of zero indicates that the Logical Unit shall not report recovered errors. Error recovery procedures shall be performed within the limits established by the error recovery parameters. In order to enhance data recovery from DVD media, error correction shall always be enabled. Thus, PER shall not apply to error corrected data. This bit for DVD media shall only be used to report when auto reallocation of a logical block has been performed. For CD media this capability is used only to report when the Layered Error correction has been used to recover the data.

A Disable Transfer on Error (DTE) bit of one indicates that the Logical Unit shall terminate the data transfer to the Initiator upon detection of a recovered error. A DTE bit of zero indicates that the Logical Unit shall not terminate the data transfer upon detection of a recovered error.

A Disable Correction (DCR) bit of one indicates that error correction codes shall not be used for data error recovery. A DCR bit of zero allows the use of error correction codes for data error recovery. In order to enhance data recovery from DVD media, error correction shall always be enabled regardless of the setting of DCR.

7.2.2.5.6 Disable Transfer on Error (DTE)

A Disable Transfer on Error (DTE) bit of one indicates that the Logical Unit shall terminate the data transfer to the Initiator upon detection of a recovered error. A DTE bit of zero indicates that the Logical Unit shall not terminate the data transfer upon detection of a recovered error.

7.2.2.5.7 Disable Correction (DCR)

A Disable Correction (DCR) bit of one indicates that error correction codes shall not be used for data error recovery. A DCR bit of zero allows the use of error correction codes for data error recovery.

7.2.2.5.8 Error Recovery Cases for CD and DDCD

An interpretation of the bits 5-0 in byte 2 for CD-ROM Logical Units is given in Table 590.

Table 590 – CD-ROM Devices, error recovery description

Error code	Description
00h	The maximum error recovery procedures available are used. If an error occurs that is uncorrectable with the error correction codes (ECC) on the media, data transfer is terminated with CHECK CONDITION status. The block with the error is not transferred. The sense key is set to MEDIUM ERROR. The information bytes give the address of the block where the un-recovered error was detected. Recovered errors are not reported.
01h	Only retries of the read operation and CIRC are used (layered error correction is not used). Only CIRC un-recovered data errors are reported. If an CIRC un-recovered data error occurs, data transfer is terminated with CHECK CONDITION status. The block with the error is not transferred. The sense key is set to MEDIUM ERROR. The information bytes give the address of the block where the un-recovered error was detected. Recovered errors are not reported.
04h	The maximum error recovery procedures available are used. Recovered data errors are reported. If a recovered data error occurs, data transfer is not terminated. However, when the data transfer has completed CHECK CONDITION status is reported. The sense key is set to RECOVERED ERROR. The information bytes give the address of the last block where a recovered data error was detected. If a data error occurs that is uncorrectable with the ECC information available on the media, data transfer is terminated and CHECK CONDITION status is reported. The block with the error is not transferred. The sense key is set to MEDIUM ERROR. The information bytes give the address of the block where the uncorrectable error was detected.
05h	Only retries of the read operation and CIRC are used (layered error correction is not used). Recovered data errors are reported. If a recovered data error occurs, data transfer is not terminated. However, when the data transfer has completed CHECK CONDITION status is reported. The sense key is set to RECOVERED ERROR. The information bytes give the address of the last block where a CIRC recovered data error was detected. If an un-recovered data error occurs, data transfer is terminated and CHECK CONDITION status is reported. The block with the error is not transferred. The sense key is set to MEDIUM ERROR. The information bytes give the address of the block where the un-recovered error was detected.
06h	The maximum error recovery procedures are used. Recovered data errors are reported. If a recovered data error occurs data transfer is terminated and CHECK CONDITION status is reported. The block with the recovered error is not transferred. The sense key is set to RECOVERED ERROR. The information bytes give the address of the block where the recovered data error was detected. If a data error occurs that is uncorrectable with the ECC information on the medium, data transfer is terminated with CHECK CONDITION status. The block with the error is not transferred. The sense key is set to MEDIUM ERROR. The information bytes give the address of the block where the uncorrectable error was detected.

Table 590– CD-ROM Devices, error recovery description (cont.)

Error Code	Description
07h	<p>Only retries of the read operation are used (layered error correction is not used). CIRC recovered data errors are reported. If a CIRC recovered data error occurs, data transfer is terminated with CHECK CONDITION status. The block with the recovered error is not transferred. The sense key is set to RECOVERED ERROR. The information bytes give the address of the block where the recovered data error was detected.</p> <p>If an CIRC un-recovered data error occurs, data transfer is terminated with CHECK CONDITION status. The block with the error is not transferred. The sense key is set to MEDIUM ERROR. The information bytes give the address of the block where the uncorrectable error was detected.</p>
10h	<p>If it is possible to maintain data transfer, the maximum error recovery procedures available are used. (RC=1.) If an error occurs that is uncorrectable with the error codes (ECC) on the media, or is uncorrectable in time to maintain data transfer, the data transfer is not terminated. However, when the data transfer has completed, CHECK CONDITION status is reported. The sense key is set to MEDIUM ERROR. The information bytes give the address of the block where the first un-recovered error was detected. Recovered errors are not reported.</p>
11h	<p>If it is possible to maintain data transfer, retries of the read operation and CIRC are used (layered error correction is not used). (RC=1.) Only CIRC un-recovered data errors are reported. If a CIRC un-recovered data error occurs, data transfer is not terminated. However, when data transfer has completed, CHECK CONDITION status is reported. The sense key is set to MEDIUM ERROR. The information bytes give the address of the block where the first un-recovered error was detected. Recovered errors are not reported.</p> <p>If a data error occurs that is uncorrectable with the ECC information available on the media, data transfer is terminated and CHECK CONDITION status is reported. The block with the error is not transferred. The sense key is set to MEDIUM ERROR. The information bytes give the address of the block where the uncorrectable error was detected.</p>
14h	<p>If it is possible to maintain data transfer, the maximum error recovery procedures available are used. (RC=1.) Recovered data errors are reported. If a recovered data error occurs, data transfer is not terminated. However, when the data transfer has completed, CHECK CONDITION status is reported. The sense key is set to RECOVERED ERROR. The information bytes give the address of the block where a recovered data error was detected.</p> <p>If an data error occurs that is uncorrectable with the ECC information available on the media, or is uncorrectable in time to maintain data transfer, the data transfer is not terminated. However, when the data transfer has completed, CHECK CONDITION status is reported. The sense key is set to MEDIUM ERROR. The information bytes give the address of the block where the first un-recovered error was detected. Reporting un-recovered errors takes precedence over reporting recovered errors.</p>
15h	<p>If it is possible to maintain data transfer, retries of the read operation and CIRC are used (layered error correction is not used). (RC=1.) Recovered data errors are reported. If a recovered data error occurs, data transfer is not terminated. However, when the data transfer has completed CHECK CONDITION status is reported. The sense key is set to RECOVERED ERROR. The information bytes give the address of the block where a CIRC recovered data error was detected.</p> <p>If an un-recovered data error occurs, data transfer is not terminated. However, when the data transfer has completed CHECK CONDITION status is reported. The sense key is set to MEDIUM ERROR. The information bytes give the address of the block where the un-recovered error was detected. Recovered errors are not reported.</p>
20h	<p>The maximum error recovery procedures available are used. If an error occurs that is uncorrectable with the error correction codes (ECC) on the media, data transfer is terminated with CHECK CONDITION status. The block with the error is transferred. The sense key is set to MEDIUM ERROR. The information bytes give the address of the block where the un-recovered error was detected. Recovered errors are not reported.</p>

Table 590– CD-ROM Devices, error recovery description (cont.)

Error Code	Description
21h	Only retries of the read operation and CIRC are used (layered error correction is not used). Only CIRC un-recovered data errors are reported. If an CIRC un-recovered data error occurs, data transfer is terminated with CHECK CONDITION status. The block with the error is transferred. The sense key is set to MEDIUM ERROR. The information bytes give the address of the block where the un-recovered error was detected. Recovered errors are not reported.
24h	The maximum error recovery procedures available are used. Recovered data errors are reported. If a recovered data error occurs, data transfer is not terminated. However, when the data transfer has completed, CHECK CONDITION status is reported. The sense key is set to RECOVERED ERROR. The information bytes give the address of the last block where a recovered data error was detected. If a data error occurs that is uncorrectable with the ECC information available on the media, data transfer is terminated and CHECK CONDITION status is reported. The block with the error is transferred. The sense key is set to MEDIUM ERROR. The information bytes give the address of the block where the uncorrectable error was detected.
25h	Only retries of the read operation and CIRC are used (layered error correction is not used). Recovered data errors are reported. If a recovered data error occurs, data transfer is not terminated. However, when the data transfer has completed CHECK CONDITION status is reported. The sense key is set to RECOVERED ERROR. The information bytes give the address of the last block where a CIRC recovered data error was detected. If an un-recovered data error occurs, data transfer is terminated and CHECK CONDITION status is reported. The block with the error is transferred. The sense key is set to MEDIUM ERROR. The information bytes give the address of the block where the un-recovered error was detected.
26h	The maximum error recovery procedures are used. Recovered data errors are reported. If a recovered data error occurs data transfer is terminated and CHECK CONDITION status is reported. The block with the recovered error is transferred. The sense key is set to RECOVERED ERROR. The information bytes give the address of the block where the recovered data error was detected. If a data error occurs that is uncorrectable with the ECC information on the medium, data transfer is terminated with CHECK CONDITION status. The block with the error is transferred. The sense key is set to MEDIUM ERROR. The information bytes give the address of the block where the uncorrectable error was detected.
27h	Only retries of the read operation are used (layer error correction is not used). CIRC recovered data errors are reported. If a CIRC recovered data error occurs, data transfer is terminated with CHECK CONDITION status. The block with the recovered error is transferred. The sense key is set to RECOVERED ERROR. The information bytes give the address of the block where the recovered data error was detected. If a CIRC un-recovered data error occurs, data transfer is terminated with CHECK CONDITION status. The block with the error is transferred. The sense key is set to MEDIUM ERROR. The information bytes give the address of the block where the un-recovered error was detected.
30h	Same as code 10h
31h	Same as code 11h
34h	Same as code 14h
35h	Same as code 15h
NOTES:	
<ol style="list-style-type: none"> 1. A CIRC Recovered Data Error is defined as a block that the CIRC based error correction algorithm was unsuccessful for a read attempt, but on a subsequent read operation no error was reported. The number of subsequent read operations is limited to the read retry count. Layered error correction was not used. 2. A CIRC Un-recovered Data Error is defined as a block that the CIRC based error correction algorithm was unsuccessful on all read attempts up to the read retry count. Layered error correction was not used. 3. An L-EC Recovered Data Error is defined as a block that the CIRC based error correction algorithm was unsuccessful, but the layered error correction was able to correct the block within the read retry count. 4. An L-EC Un-correctable Data Error is defined as a block that was not corrected by layered error correction within the read retry count. 	

7.2.2.5.9 Error Recovery Cases for DVD

An interpretation of the bits 5-0 in byte 2 for DVD-ROM Logical Units is given in Table 591.

Table 591 – DVD Devices, Error Recovery Description

Code	Error Recovery Description
00h	The maximum error recovery procedures available are used. If an error occurs that is uncorrectable with the error correction codes (ECC) on the media, data transfer is terminated with CHECK CONDITION status. The block with the error is not transferred. The sense key is set to MEDIUM ERROR. The information bytes give the address of the block where the un-recovered error was detected. Recovered errors are not reported.
04h	The maximum error recovery procedures available are used. Recovered data errors are reported. If a recovered data error occurs, data transfer is not terminated. However, when the data transfer has completed CHECK CONDITION status is reported. The sense key is set to RECOVERED ERROR. The information bytes give the address of the last block where a recovered data error was detected. If a data error occurs that is uncorrectable with the ECC information available on the media, data transfer is terminated and CHECK CONDITION status is reported. The block with the error is not transferred. The sense key is set to MEDIUM ERROR. The information bytes give the address of the block where the uncorrectable error was detected. The only possible recovered errors are when a block is automatically reassigned using ARRE.
10h	If it is possible to maintain data transfer, the maximum error recovery procedures available are used. (RC = 1.) If an error occurs that is uncorrectable with the error correction codes (ECC) on the media, or is uncorrectable in time to maintain data transfer, the data transfer is not terminated. However, when the data transfer has completed, CHECK CONDITION status is reported. The sense key is set to MEDIUM ERROR. The information bytes give the address of the block where the first unrecovered error was detected. Recovered errors are not reported.
20h	The maximum error recovery procedures available are used. If an error occurs that is uncorrectable with the error correction codes (ECC) on the media, data transfer is terminated with CHECK CONDITION status. The block with the error is transferred. The sense key is set to MEDIUM ERROR. The information bytes give the address of the block where the un-recovered error was detected. Recovered errors are not reported.
24h	The maximum error recovery procedures available are used. Recovered data errors are reported. If a recovered data error occurs data transfer is not terminated. However, when the data transfer has completed, CHECK CONDITION status is reported. The sense key is set to RECOVERED ERROR. The information bytes give the address of the last block where a recovered data error was detected. If a data error occurs that is uncorrectable with the ECC information available on the media data transfer is terminated and CHECK CONDITION status is reported. The block with the error is transferred. The sense key is set to MEDIUM ERROR. The information bytes give the address of the block where the uncorrectable error was detected. The only possible recovered errors are when a block is automatically reassigned using ARRE.

7.2.2.6 Read Retry Count

The Read Retry Count field specifies the number of times that the Logical Unit shall attempt its read recovery algorithm.

7.2.2.7 Enhanced Media Certification and Defect Reporting (EMCDR)

The Enhanced Media Certification and Defect Reporting (EMCDR) field controls medium certification and error reporting of logical unit. This field is used in conjunction with PER bit. Initiator should set this field to 0 if logical unit does not support Enhanced Defect Reporting feature. The description of this bit is described in 7.2.2.7.1.

7.2.2.7.1 Description of PER bit and EMCDR field

Description of PER bit and EMCDR field is different if Enhanced Defect Reporting Feature is supported and is current. Following sub-clause 7.2.2.7.2 and 7.2.2.7.3 describe the description. By the setting PER bit and EMCDR field to 0, DBI data shall not be cleared.

7.2.2.7.2 In case of Enhanced Defect Reporting Feature is not supported or is not current

If the logical unit does not support Enhanced Defect Reporting Feature, Initiator should set EMCDR field to 0.

If logical unit supports Enhanced Defect Reporting Feature and Enhanced Defect Reporting Feature is not current, logical unit shall ignore the EMCDR field setting.

A Post Error (PER) bit of one indicates that the logical unit shall report recovered errors. A PER bit of zero indicates that the logical unit shall not report recovered errors. Error recovery procedures shall be performed within the limits established by the error recovery parameters. This capability is very different for DVD media. To be able to recover the data from DVD media, error correction shall be used. Thus it is not reasonable to report when ECC is used to recover the data. This bit for DVD-RAM media shall only be used to report when auto reallocation of a logical block has been performed. For CD media this capability is used to report when the Layered Error correction has been used to recover the data.

Again as the CIRC is mandatory for recovery of data, then CIRC Recovered Data Error is defined as follows.

A CIRC Recovered Data Error is defined as a block for which the CIRC based error correction algorithm was unsuccessful for a read attempt, but on a subsequent read operation no error was reported. The number of subsequent read operations is limited to the read retry count. Layered error correction was not used.

A CIRC Unrecovered Data Error is defined as a block for which the CIRC based error correction algorithm was unsuccessful on all read attempts up to the Read Retry count. Layered error correction was not used.

An L-EC Recovered Data Error is defined as a block for which the CIRC based error correction algorithm was unsuccessful, but the layered error correction was able to correct the block within the read retry count.

An L-EC Uncorrectable Data Error is defined as a block that was not corrected by layered error correction within the Read Retry count.

7.2.2.7.3 In case of Enhanced Defect Reporting Feature is current

When Enhanced Defect Reporting Feature is supported and is current, logical unit behavior is described in 4.6, "Logical unit assisted software defect management model". The relationship of PER and EMCDR is shown in Table 592.

Table 592 – Relationship of PER and EMCDR when Enhanced Defect Reporting Feature is current

PER	EMCDR	Logical Unit Responses
0	0	Logical Unit shall not certify medium on read operation and shall not report recovered error
	1	Logical unit shall certify medium on read operation and verify operation, and shall not report recovered error
	2	Logical unit shall certify medium on read operation and verify operation, and shall report recovered error or unrecovered error on verify operation.
	3	Logical unit shall certify medium on read operation and verify operation, and shall report recovered error or unrecovered error on read operation and verify operation
1	0	Behavior is described in 7.2.2.7.2
	1	Certify medium on read operation and verify operation. Recovered errors shall be reported as RECOVERED ERROR/RECOVERED DATA – RECOMMEND REASSIGNMENT.
	2	
	3	

7.2.2.8 Write Retry Count

The Write Retry Count field specifies the number of times that the Logical Unit shall attempt its write recovery algorithm.

7.3 MRW Mode Page (Page Code 03h)

7.3.1 Introduction

The MRW Mode Page (Table 594) provides a method by which the Initiator may control the special features of a MRW CD-RW Logical Unit.

Table 593 shows the Features associated with the MRW Mode Page.

Table 593 – Features Associated with the MRW Mode Page

Feature Number	Feature Name	Requirement
0028h	MRW	Mandatory

7.3.2 The Mode Page and its Parameters

7.3.2.1 The Mode Page

Table 594 – MRW Mode Page

Byte	Bit	7	6	5	4	3	2	1	0
0		PS	Resvd	Page Code (03h)					
1		Page Length (06h)							
2		Reserved							
3		Reserved							LBA Space
4		Reserved							
5		Reserved							
6		Reserved							
7		Reserved							

7.3.2.2 PS

The Parameters Savable (PS) bit is defined in 7.1.4.1.

7.3.2.3 Page Code

The Page Code field shall be set to 03h, identifying the MRW Mode Page.

NOTE 31: This mode page may be implemented as Page Code 2Ch, a vendor unique code. Use of Page Code 2Ch is obsolete. In order to avoid compatibility problems, it is recommended that both Logical Units and Initiators implement both codes.

7.3.2.4 Page Length

The Page Length shall be set to 06h.

7.3.2.5 LBA Space

If the currently mounted medium is a MRW disc, then the value of LBA Space defines the current address space available to the Initiator. If LBA Space is set to 0, the Logical Unit shall reference the DMA for all LBA space reads and writes. If LBA Space is set to 1, the Logical Unit shall reference the GAA for all LBA space reads and writes.

After power-on, any reset, or a medium change, the LBA Space value shall be set to zero. This assures that the default LBA Space is always the DMA.

Whenever Initiator changes the LBA Space bit, the Logical Unit shall generate an Operational Change Event to indicate that the currency of features has changed (e.g. Hardware Defect Management).

All commands that refer to the LBA space of the medium is restricted to the LBA space selected by this mode page.

7.4 Write Parameters Mode Page (Page Code 05h)

7.4.1 Introduction

The Write Parameters Mode Page (Table 596) provides parameters that are often needed in the execution of commands that write to the media. After power-on or hard reset, the Logical Unit shall assign default values according to some supported medium.

Table 595 shows the Features associated with the Write Parameters Mode Page.

Table 595 – Features Associated with the Write Parameters Mode Page

Feature Number	Feature Name	Requirement
0021h	Incremental Streaming Writable	Mandatory
0026h	Restricted Overwrite	Mandatory
0027h	CD-RW CAV Write	Mandatory
002Dh	CD Track-At-Once	Mandatory
002Eh	CD Mastering (Both SAO and Raw)	Mandatory
002Fh	DVD-R/-RW Write Feature	Mandatory

7.4.2 Applicable Media

This mode page is useful for CD-R, CD-RW (not MRW formatted), DDCD-R, DDCD-RW, DVD-R, and DVD-RW media.

For DVD-RW media, if a medium is in Sequential recording mode, usage of this mode page shall conform to descriptions for DVD-R unless otherwise specified. If a medium is in Restricted overwrite mode, this mode page shall not be used.

The values in this page do not necessarily reflect the status on a given medium.

If any parameter value is incompatible with the current medium, the Logical Unit shall terminate any write type command with CHECK CONDITION status and set SK/ASC/ASCQ values to ILLEGAL REQUEST/ILLEGAL MODE FOR THIS TRACK. Fields not required or ignored for the current medium may contain 0 for the default mode parameter value.

7.4.3 Exempted Media

The parameters specified in this mode page are not applicable to DVD-RAM, DVD+R, DVD+RW, and any media that is formatted as MRW. When any of these media is mounted and recognized by the Logical Unit, it shall set write speed and internal write parameters as needed to properly access the medium. This shall be done without Initiator intervention. Furthermore, the Logical Unit shall not modify the current parameters of the Write Parameters Mode Page.

If the Initiator changes the Write Parameters Mode Page, operation with the medium shall not be affected. When a CD-RW disc is mounted that does not have the MRW format and a FORMAT UNIT command is sent for the purpose of formatting the disc as MRW, the same rule applies. Specifically, the Initiator is not required to set the Write Parameters Mode Page prior to sending the FORMAT UNIT command when specifying format type 24h (MRW). Furthermore, the Logical Unit shall not alter current the Write Parameters Page in performing the format.

7.4.4 The Mode Page and its Parameters

7.4.4.1 The Mode Page

The mode page format is shown in Table 596.

Table 596 – Write Parameters Page

Byte	Bit	7	6	5	4	3	2	1	0
0		PS	Reserved	Page Code (05h)					
1		Page Length (32h or 36h)							
2		Reserved	BUFE	LS_V	Test Write	Write Type			
3		Multi-session		FP	Copy	Track Mode			
4		Reserved				Data Block Type			
5		Link Size							
6		Reserved							
7		Reserved		Initiator Application Code					
8		Session Format							
9		Reserved							
10	(MSB)	Packet Size							
11									
12									
13	(LSB)								
14	(MSB)	Audio Pause Length							
15		(LSB)							
16	(MSB)	Media Catalog Number							
17									
...									
30									
31	(LSB)								
32	(MSB)	International Standard Recording Code							
33									
...									
46									
47	(LSB)								
48		Sub-header Byte 0							
49		Sub-header Byte 1							
50		Sub-header Byte 2							
51		Sub-header Byte 3							
52 – 55		Vendor Specific							

7.4.4.2 PS

The Parameters Savable (PS) bit is defined in 7.1.4.1.

7.4.4.3 Page Code

The Page Code field shall be set to 05h, identifying the Write Parameters Mode Page.

7.4.4.4 Page Length

The Page Length shall be set to either 32h or 36h, depending upon support for the Vendor Specific field.

7.4.4.5 BUFE

The meaning and use of the BUFE (Buffer Under-run Free recording enable) bit is described in Table 597.

Table 597 – Use of BUFE bit

Logical Unit action with BUFE bit as applied to...		
CD-R and CD-RW	0	Buffer Under-run Free recording is disabled. When performing sequential recording and Logical Unit's write buffer becomes empty, it shall perform linking and terminate writing.
	1	Buffer Under-run Free recording is enabled for sequential recording. The Logical Unit shall perform zero-loss linking and continue writing when the buffer becomes non-empty.
DVD-RAM, DVD+R and DVD+RW	0	The setting of BUFE has no meaning for either DVD-RAM, DVD+R or DVD+RW media and shall be ignored.
	1	
DVD-R and DVD-RW	0	Buffer Under-run Free recording is disabled. When performing sequential recording and Logical Unit's write buffer becomes empty, it shall perform linking and terminate writing.
	1	Buffer Under-run Free recording is enabled for sequential recording. The Logical Unit shall perform zero-loss linking and continue writing when the buffer becomes non-empty.

7.4.4.6 LS_V

If the LS_V (Link Size Valid) bit is set to one, the value in the Link Size field is valid. If the LS_V bit is set to zero, the Link Size field shall be assumed to contain 7.

7.4.4.7 Link Size

The Link Size field specifies the Linking Loss area size in sectors. The Link Size field is valid only for Write Type "Packet/Incremental." When another Write Type is specified, the Logical Unit shall ignore both LS_V bit and Link Size field. The Logical Unit shall accept values that are valid for the Logical Unit but not valid for the current medium. If writing is attempted when an invalid Link Size is set, the Logical Unit shall generate CHECK CONDITION status and set SK/ASC/ASCQ values to ILLEGAL REQUEST/ILLEGAL MODE FOR THIS TRACK.

7.4.4.8 Test Write

On CD-R/RW media the Test Write bit is valid only for Write Type 1 or 2 (Track at Once or Session at Once). On DDCD-R/RW media the Test Write bit is valid only for Write Type 1 or 2 (Track at Once or Session at Once). On DVD-R media, the Test Write bit is valid only for Write Type 0 or 2 (Incremental or Disc-at-once). When the Test Write bit is set to one, it indicates that the device performs the write process, but does not write data to the media. When the bit is set to zero the Write laser power is set such that user data is transferred to the media. In addition, all track and disc information collected, during test write mode, shall be cleared. It should be noted that the number of tracks reserved or written may be limited in test write mode.

7.4.4.9 Write Type

Write Type Field (Table 598) specifies the stream type to be used during writing. Write Type values are shown in Table 598.

Table 598 – Write Type Field

Value	Definition
00h	Packet/Incremental
01h	Track-at-once
02h	Session-at-once
03h	RAW
04h – 0Fh	Reserved

Packet/Incremental – the device shall perform Packet/Incremental writing when WRITE commands are issued.

Track At Once – the device shall perform Track At Once recording when write commands are issued.

Session At Once – the device shall perform Session At Once recording. For CD, this mode requires that a cue sheet be sent prior to sending write commands.

RAW – the device shall write data as received from the Initiator. In this mode, the Initiator sends the Lead-in. The Initiator should provide Q Sub-channel in this mode, the only valid Data Block Types are 1, 2, and 3. The Next Writable Address starts at the beginning of the Lead-in (this shall be a negative LBA on a blank disc).

In RAW record mode the Logical Unit shall not generate run-in and run-out blocks (main and Sub-channel 1 data) but shall generate and record the link block. Write Type of Track-at-once and RAW are invalid when DVD-R media is present.

The Multi-session field defines how session closure affects the opening of the next session. See Table 599.

Table 599 – Multi-session Field Definition

Multi-session Field	Action Upon Session Closure
00b	No B0 pointer. Next Session not allowed
01b	For the CD media, B0 pointer = FF:FF:FF. Next session not allowed. For the DDCD media, B0 pointer = F:FF:FF:FF. Field reserved for non-CD media
10b	Reserved
11b	Next session allowed. B0 pointer = next possible program area.

7.4.4.10 FP

The FP bit, when set to one indicates that the packet type is fixed. Otherwise, the packet type is variable. This bit is ignored unless the write type is set to 0 (Packet). For DVD-R, this bit shall default to one.

7.4.4.11 Copy

When Copy is set to one, SCMS recording is enabled. During recording, the copyright bit in the control nibble of each mode 1 Q Sub-channel shall alternate between 1 and 0 at 9.375 Hz. The duty cycle is 50%, changing every 4 blocks. The initial value on the medium is zero.

When Copy is zero, SCMS recording is disabled.

For DDCD, this bit shall be set to zero.

7.4.4.12 Track Mode

Track Mode is the Control nibble in all Mode 1 Q Sub-channel in the track. The default value of this field for DVD-R Logical Units shall be 5. The default value of this field for DDCD-R/RW Logical Units shall be 5.

7.4.4.13 Data Block Type

Data Block Type defines both the specific data fields in a user data block and its size. The Data Block Type codes are defined in Table 600. This size is used for writing instead of the block size set in the mode select header. The default value of this field for DVD-R Logical Units shall be 8. The default value of this field for DDCD-R/RW Logical Units shall be 8.

Table 600 – Data Block Type Codes

Value	Block Size	Definition	Requirement
0	2 352	Raw data 2 352 bytes of raw data (not valid for write type = packet)	Optional
1	2 368	Raw data with P and Q Sub-channel 2 352 bytes of raw data, 16 bytes for P & Q Sub-channel (see Table 354): Bytes 0..9 are Q Sub-channel data Bytes 10..11 are Q Sub-channel EDC Bytes 12..14 are zero Byte 15, most significant bit has state of P Sub-channel bit (not valid for write type = packet)	Optional
2	2 448	Raw data with P-W Sub-channel appended: 2 352 bytes of raw data. 96 bytes of pack form R-W Sub-channel in the low order 6 bits of each byte. Bit 7 of each byte contains the P Sub-channel state and bit 6 of each byte contains the Q Sub-channel bit. (not valid for write type = packet)	Optional
3	2 448	Raw data with raw P-W Sub-channel appended: 2 352 bytes of raw data. 96 bytes of raw P-W Sub-channel. (not valid for write type = packet)	Optional
4 – 6		Reserved values	
7	NA	Vendor Specific	Optional
8	2 048	Mode 1 (ISO/IEC 10149): 2 048 bytes of user data	Mandatory
9	2 336	Mode 2 (ISO/IEC 10149): 2 336 bytes of user data.	Optional
10	2 048	Mode 2 (CD-ROM XA, form 1): 2 048 bytes of user data, sub-header from write parameters.	Mandatory
11	2 056	Mode 2 (CD-ROM XA, form 1): 8 bytes of sub-header, 2 048 bytes of user data	Optional
12	2 324	Mode 2 (CD-ROM XA, form 2): 2 324 bytes of user data. Sub-header is taken from write parameters.	Optional
13	2 332	Mode 2 (CD-ROM XA, form 1, form 2, or mixed form): 8 bytes of sub-header 2 324 bytes of user data	Mandatory
14	-	Reserved values	
15	NA	Vendor Specific	Optional

The Logical Unit is required to automatically generate CD frame data according to the following:

1. When a track has been designated for packet writing, the device shall ensure that the TDB is written upon receipt of the first write command for the track.
2. With the exceptions of data block types 1, 2, and 3, the device shall generate all P Sub-channel and all mode 1, mode 2, and mode 3 Q Sub-channel.
3. For data block types 8 through 13, the device shall generate all sync fields and all headers.
4. For data blocks of mode 1 or of mode 2, form 1, the device shall generate EDC and L-EC parity.
5. For data block types 0, 1, 2, and 3, the device shall perform no data scrambling per ISO/IEC 10149.
6. For data block types 8 through 13, the device shall perform data scrambling per ISO/IEC 10149.
7. Only Type 10 is valid for DDCD media.

7.4.4.14 Initiator Application Code

The Initiator Application Code field typically has the value zero. When the unrestricted Use Disc bit in the Disc Information Block (Table 361) is set to one, the Initiator Application Code field shall be ignored by the device. If the Unrestricted Use Disc bit is zero, then the Initiator Application Code shall be set to the appropriate value for the medium in order that writing be allowed. An Initiator Application Code of zero is used for a Restricted Use – General Purpose Disc.

7.4.4.15 Session Format Code

The Session Format code is to be written in the TOC of the session containing this track. The Session Format code is the PSEC byte of the mode 1, point A0 TOC entry. For DDCD media, this is always set to 20h.

Table 601 – Session Format Codes

Session Format Codes	Session Format
00h	CD-DA, or CD-ROM or other data discs
10h	CD-I Disc
20h	CD-ROM XA Disc, DDCD Disc
All Other Values	Reserved

7.4.4.16 Packet Size

The Packet Size field, if FP bit is set to one, specifies the number of User Data Blocks per fixed packet. The Packet Size field, if FP bit is set to 0, shall be ignored. For DVD-R media, the default Packet Size shall be 16. Audio Pause Length is the number of blocks from the beginning of the track that the mode 1 Q Sub-channel INDEX shall be zero. If this number is zero, then there is no period where the Mode 1 Q Sub-channel INDEX shall be zero. The default value shall be 150. This field is valid only for audio tracks, otherwise it is ignored.

7.4.4.17 Media Catalog Number (MCN)

The Media Catalog Number (MCN) is valid only for writable CD and DDCD media. This field shall be ignored when other media types are present. The MCN shall be written in the mode 2 Q Sub-channel in at least one out of every 100 blocks in the program area. MCN in the Write Parameters Mode Page is formatted as in Table 602. MCVAL is the MCN valid flag. If MCVAL is zero, then the content of bytes 17 through 31 shall be ignored. If MCVAL is one, the bytes 17 through 31 contain a valid MCN. The MCN digits are ASCII representations of decimal digits (30h through 39h). The Initiator may specify the content of bytes 14 & 15; however, the Logical Unit shall ignore these bytes and insert the appropriate Zero and AFRAME values.

Table 602 – Media Catalog Number Format

Bit	7	6	5	4	3	2	1	0
Byte								
16	MCVAL	Reserved						
17	MCN digit N1 (Most significant)							
18	MCN digit N2							
19	MCN digit N3							
...	...							
28	MCN digit N12							
29	MCN digit N13 (Least significant)							
30	Zero							
31	AFRAME							

7.4.4.18 International Standard Recording Code (ISRC)

The International Standard Recording Code (ISRC) is valid only for Writable CD media. This field shall be ignored when other media types are present. The ISRC shall be written in the mode 3 Q Sub-channel in at least one out of every 100 blocks in the track. ISRC in the Write Parameters Mode The ISRC is formatted as in Table 603.

Table 603 – International Standard Recording Code Format

Bit	7	6	5	4	3	2	1	0																								
Byte																																
32	TCVAL	Reserved																														
33	Country Code: I1																															
34									I2																							
35	Owner Code: I3																															
36									I4																							
37																	I5															
38	Year of Recording: I6																															
39									I7																							
40	Serial Number: I8																															
41									I9																							
42																	I10															
43																									I11							
44																																
45	Zero																															
46	AFRAME																															
47	Reserved																															

Sub-header bytes 0 through 3 contain sub-header bytes to be used when recording CD-R/-RW or DDCD-R/-RW with Data Block Types 10 and 12.

The Vendor Unique field should be ignored if the Logical Unit does not support this field.

7.5 Caching Mode Page (08h)

7.5.1 Introduction

The caching parameters page defines the parameters that affect the use of the cache.

7.5.2 The Mode Page and its Parameters

7.5.2.1 The Mode Page

Table 604 – Caching mode page Format

Bit	7	6	5	4	3	2	1	0
0	PS	Reserved	Page Code (08h)					
1	Page Length (0Ah)							
2	Reserved					WCE	Reserved	RCD
3	Reserved							
...								
11								

7.5.2.2 PS

The Parameter Savable bit is defined in 7.1.4.1.

7.5.2.3 Page Code

The Page Code is set to 08h, identifying the Caching mode page.

7.5.2.4 Page Length

Page Length shall be set to 0Ah.

7.5.2.5 WCE (Write Cache Enable)

A Write Cache Enable (WCE) bit of zero specifies that the Logical Unit shall return GOOD status for a WRITE command after successfully writing all of the data to the medium. A WCE bit of one specifies that the Logical Unit may return GOOD status for a WRITE command after successfully receiving the data and prior to having successfully written it to the medium.

7.5.2.6 RCD (Read Cache Disable)

A read cache disable (RCD) bit of zero specifies that the Logical Unit may return data requested by a READ command by accessing either the cache or media. A RCD bit of one specifies that the Logical Unit shall transfer all of the data requested by a READ command from the medium (i.e., data shall not be transferred from the cache).

7.6 CD Audio Control Page (Page Code 0Eh)

7.6.1 Introduction

The CD Audio Control Page (Table 606) sets the playback modes and output controls for subsequent PLAY AUDIO commands and any current audio playback operation.

Table 605 shows the Features associated with the CD Audio Control Page.

Table 605 – Features Associated with the CD Audio Control Page

Feature Number	Feature Name	Requirement
0103h	CD Audio External Play	Mandatory

7.6.2 The Mode Page and its Parameters

7.6.2.1 The Mode Page

Table 606 – CD Audio Control Page Format

Byte	Bit	7	6	5	4	3	2	1	0
0	PS	Reserved	Page Code (0Eh)						
1	Page Length (0Eh)								
2	Reserved					IMMED	SOTC	Reserved	
3	Reserved								
4	Reserved								
5	Reserved								
6	Reserved								
7	Reserved								
8	Reserved					CDDA Output Port 0 Channel Selection			
9	Output Port 0 Volume Default FFh								
10	Reserved					CDDA Output Port 1 Channel Selection			
11	Output Port 1 Volume Default FFh								
12	Reserved					CDDA Output Port 2 Channel Selection			
13	Output Port 2 Volume Default 00h								
14	Reserved					CDDA Output Port 3 Channel Selection			
15	Output Port 3 Volume Default 00h								

7.6.2.2 PS

The Parameter Savable bit is defined in 7.1.4.1.

7.6.2.3 Page Code

The Page Code is set to 0Eh, identifying the CD Audio Control Mode Page.

7.6.2.4 Page Length

Page Length shall be set to 0Eh.

7.6.2.5 IMMED

The Immediate Bit (IMMED) is used for information purposes only; audio play commands shall send completion status as soon as the playback operation has been started. This bit shall be set to 1.

7.6.2.6 SOTC

A Stop On Track Crossing (SOTC) bit of zero indicates the Logical Unit shall terminate the audio playback operation when the transfer length is satisfied. Multiple tracks shall be played as necessary. Periods of time encoded as audio pause/silence at the beginning of tracks, (index 0) shall also be

played. A SOTC bit of one indicates the Logical Unit shall terminate the audio playback operation when the beginning of a following track is encountered. The default value for the SOTC bit is zero.

7.6.2.7 CDDA Output Port Channel Selection

The CDDA Output Port Channel Selection field (Table 607) specifies the Red Book audio channels that a specific output port shall be connected. More than one output port may be connected to an audio channel. More than one audio channel may be connected to an output port.

Table 607 – CDDA Output Port Channel Selection Codes

Code	Description
0000b	Output port muted
0001b	Connect audio channel 0 to this output port
0010b	Connect audio channel 1 to this output port
0011b	Connect audio channel 0 and audio channel 1 to this output port
0100b	Connect audio channel 2 to this output port
1000b	Connect audio channel 3 to this output port

7.6.2.8 Output Port Volume Control

The Output Port Volume Control indicates the relative volume level for this audio output port. The value used is specified as an attenuation of the normal volume level. A value of zero indicates the minimum volume level (Mute), and a value of FFh indicates maximum volume (No attenuation) level. It is recommended that the MUTE and volume functions should be supported on a per channel basis. The attenuation used shall be as specified in Table 608. All values not shown in the table shall be valid, with the attenuation selected by interpolating using the known table values.

It is recommended that the Logical Unit support at least 16 volume levels. The actual attenuation levels for any given Binary attenuation value shall be given by the following equation: $20 \text{ Log} ((\text{Binary Level} + 1) / 256)$

NOTE 32: Audio channel volume control regarding channel selection of MUTE vs. Volume Level setting of 0. It is recommended that Logical Units allow the setting of the Channel Selection fields to MUTE and also allow the setting of the Volume Level field to 0. It is up to the Logical Unit to determine how to shut off the volume, either via muting circuitry or via the volume control.

Table 608 – Attenuation Levels for Audio

Binary Level	Attenuation
FFh	0db (0n)
F0h	-0.52
E0h	-1.12
C0h	-2.45
80h	-5.95
40h	-11.9
20h	-17.8
10h	-23.6
0Fh	-24.1
0Eh	-24.6
0Ch	-25.9
08h	-29.1
04h	-34.2
02h	-38.6
01h	-42.1
00h	Mute (Off)

7.7 Power Condition mode page (Page Code 1Ah)

7.7.1 Introduction

The Power Condition mode page provides the Initiator with a means to control the length of time a Logical Unit delays before changing its power requirements. There are notification events to the Initiator that a Logical Unit has changed power conditions.

On the receipt of a command the Logical Unit shall adjust itself to the power condition that allows the command to process. The timer that maps to this power condition and any lower power condition timers shall be reset on receipt of the command. On completion of the command the timer associated with this power condition shall be restarted.

Table 609 shows the Features associated with the Power Condition mode page.

Table 609 – Features Associated with the Power Condition mode page

Feature Number	Feature Name	Requirement
0100h	Power Management	Mandatory

The Power Condition Mode Page is described in SPC-3.

7.8 Informational Exceptions Control Mode Page (Page Code 1Ch)

7.8.1 Introduction

The Informational Exceptions Control Mode Page defines the methods used by the target to control the reporting and the operations of specific informational exception conditions. This page shall only apply to informational exceptions when CHECK CONDITION status is reported and ASC set to FAILURE PREDICTION THRESHOLD EXCEEDED to the Initiator.

NOTE 33: This mode page was named the Fault/Failure Reporting Control page in earlier versions of this standard. The name has been changed in order to be consistent with SPC-3.

Informational exception conditions occur as a result of vendor specific events within a target. An informational exception condition may occur asynchronous to any commands issued by an Initiator.

Table 610 shows the Features associated with the Informational Exceptions Control mode page.

Table 610 – Features Associated with the Informational Exceptions Control mode page

Feature Number	Feature Name	Requirement
0101h	SMART	Mandatory when PP bit = 1

The Informational Exceptions Control Mode Page is described in SPC-3.

7.9 Timeout and Protect Page (Page Code 1Dh)

7.9.1 Introduction

The Timeout and Protect page (Table 612) specifies parameters that affect Logical Unit operation. Table 611 shows the Features associated with the Timeout and Protect Page.

Table 611 – Features Associated with the Timeout and Protect Page

Feature Number	Feature Name	Requirement
0105h	Timeout	Mandatory

7.9.2 The Mode Page and its Parameters

7.9.2.1 The Mode Page

Table 612 – Timeout & Protect Page

Byte	Bit	7	6	5	4	3	2	1	0	
0		PS	Reserved	Page Code (1Dh)						
1		Page Length (08h)								
2		Reserved								
3		Reserved								
4		Reserved			G3Enable	TMOE	DISP	SWPP		
5		Reserved								
6	(MSB)	Group 1 Minimum Timeout (Seconds)								(LSB)
7										
8	(MSB)	Group 2 Minimum Timeout (Seconds)								(LSB)
9										

7.9.2.2 PS

The Parameters Savable (PS) bit is defined in 7.1.4.1.

7.9.2.3 Page Code

The Page Code field shall be set to 1Dh, identifying the Timeout and Protect Page.

7.9.2.4 Page Length

The Page Length shall be set to 08h.

7.9.2.5 G3Enable

G3Enable bit, when set to one, enables the Group 3 timeout capability. A G3Enable bit of zero disables the Group 3 timeout capability. In order to minimize compatibility problems, the default value for G3Enable bit should be set to zero.

7.9.2.6 TMOE

The Timeout Enable bit (TMOE), when set to one, enables reporting a Group 1 Timeout as an error: UNIT ATTENTION/INSUFFICIENT TIME FOR OPERATION and the Command Specific Information field of the sense data contains a correct timeout value for retry. When set to zero, the error shall not be reported. When TMOE is zero, the Initiator may discover a Group 1 timeout only via the Device Busy Event (see 6.7.2.7).

The default value for TMOE shall be 0. The Initiator should select TMOE for correct operation based upon its execution environment.

7.9.2.7 DISP

The DISP bit when set to 1 shall make the Logical Unit unavailable until power has been removed

and then reapplied. The Logical Unit shall report not ready for all media access after this bit has been set to 1. The default value for DISP shall be 0.

7.9.2.8 SWPP

The SWPP bit provides a Software Write Protect until power has been removed and then reapplied. When this bit is set to 1 the Logical Unit shall prevent writes to the media. When the bit is set to 1, the Logical Unit shall synchronize the write to the media before preventing any further writes. The default value for SWPP shall be 0.

7.9.2.9 Group 1 Minimum Timeout

The Group 1 Minimum Timeout shall be initialized to a value recommended by the Logical Unit. Changing this value is vendor specific.

7.9.2.10 Group 2 Minimum Timeout

The Group 2 Minimum Timeout shall be initialized to a value recommended by the Logical Unit. Although it is recommended that this value not be changeable, changing this value is vendor specific. See the Timeout model (4.1.8) for more information on the Group 1 & 2 Minimum Timeout fields and Group 3 Timeout field.

**This page is intentionally
blank.**

Annex A Implementation Notes: ATA Layer of ATAPI (Informative)

A.1 Introduction

ATAPI is a layered interface. The underlying interface is ATA utilizing a small subset of the ATA command set. The ATA Packetized Interface (ATAPI) provides a mechanism for transferring and executing SCSI CDBs. Since ATA is a single-Initiator environment, all SCSI commands that are uniquely associated multi-Initiator situations are neither needed by nor defined for ATAPI devices.

This annex describes the implementation of the packetized layer in the specific case of MM devices. For details on implementing ATAPI on ATA, see AT Attachment with Packet Interface - 7 (ATA/ATAPI-7, ANSI NCITS.xxx:200x).

A.2 General

A.2.1 Terms

A.2.1.1 Initiator

The SCSI term "Initiator" is typically replaced by the term "Host" when the underlying interface is not multi-Initiator. This is the case for ATAPI.

A.2.1.2 Device

The SCSI term "Device Server" is typically replaced by the term "Device" when the underlying interface does not support multiple physical units. MM devices have exactly one physical Logical Unit.

A.2.1.3 Command Packet

"Command Packet" is sometimes used in place of "CDB".

A.2.2 Command Packet Format

The MM ATAPI command packet is fixed at 12 bytes. A 6-byte, 10-byte, or 12-byte SCSI CDB is placed within the ATAPI command packet as shown in Table A.1 , Table A.2 , and

Table A.3 . MM ATAPI devices do not support 16-byte SCSI commands.
 Within the CDB, the Control byte is reserved and is set to zero.

Table A.1 – ATAPI Command Packet containing a 6-Byte CDB

Bit	7	6	5	4	3	2	1	0
Byte								
0	Command Operation Code (00h – 1Fh)							
1	Command Parameters							
2								
3								
4								
5	Control Byte = 00h							
6	ATAPI Pad – all zeros							
...								
11								

Table A.2 – ATAPI Command Packet containing a 10-Byte CDB

Bit	7	6	5	4	3	2	1	0
Byte								
0	Command Operation Code (20h – 5Fh,)							
1	Command Parameters							
2								
3								
4								
5								
6								
7								
8								
9	Control Byte = 00h							
10	ATAPI Pad Byte (00h)							
11	ATAPI Pad Byte (00h)							

Table A.3 – ATAPI Command Packet containing a 12-Byte CDB

Bit	7	6	5	4	3	2	1	0
Byte								
0	Command Operation Code (A0h – BFh)							
1	Command Parameters							
2								
3								
4								
5								
6								
7								
8								
9								
10								
11	Control Byte = 00h							

A.2.3 Command Status

ATAPI supports only the GOOD and CHECK CONDITION status values.

A.2.4 No Block Descriptors in MM ATAPI Devices

MM ATAPI devices do not implement Block Descriptors in mode data. The default block size for MM ATAPI devices is 2 048. Other block sizes may be supported.

A.2.5 Use of Immediate

MM ATAPI devices using the parallel ATAPI do not have the opportunity to use the Disconnect/Reselect mechanism of SCSI. Consequently, the use of immediate operations has a greater importance in MM ATAPI devices. In particular, CD Audio analog play is an immediate operation. Serial ATAPI provides a low level solution to the lack of Disconnect/Reselect.

A.2.6 Mapping of Reset Functions

Table A.4 shows how the different reset functions specified in the SCSI standards are used in this standard. This table is not intended to show all possible resets or their mapping.

Table A.4 – Example Reset Function Mapping in ATAPI

Reset Type	ATAPI
Power-On Reset	Same as SCSI Power-On Reset
Hard Reset	Hard Reset
	ATA SRST. This is a channel reset and as such is treated as a Hard Reset. However, the SRST does not reset any mode parameters to the default state.
Logical Unit Reset	ATA Device Reset command

**This page is intentionally
blank.**

Annex B Implementation Notes: SCSI Parallel Interface (Informative)

B.1 Introduction

This standard is intended to be used in conjunction with the SCSI Architecture Model (SAM-3), the SCSI Primary Command Set (SPC-3), and the SCSI Parallel Interface (SPI-5).

B.2 SCSI Signal Utilization

The Logical Unit utilizes the same signals and timing as specified in SPI-5.

B.3 Reset Functionality

B.3.1 Power On Reset

The Power On Reset is an event that causes the Power On condition in SCSI. See SAM-3.

B.3.2 Hard Reset

Hard Reset is described in the SCSI Architecture Model. See "Hard Reset" in SAM-3.

A Hard Reset for a SCSI Device:

- Aborts all tasks in all task sets;
- Clears all auto contingent allegiance conditions;
- Releases all SCSI device reservations;
- Return any device operating modes to their appropriate initial conditions, similar to those conditions that might be found following device power-on. The MODE SELECT conditions are restored to their last saved values if saved values have been established. MODE SELECT conditions for which no saved values, have been established, are returned to their default values;
- Unit Attention condition is set.

B.3.3 TARGET RESET task management function

The TARGET RESET function may be used to reset all Logical Units in the Target.

NOTE 34: The TARGET RESET task management function as described in SPI-5 was called a "Bus Device Reset" in SCSI-2.

If the Initiator issues the LOGICAL UNIT RESET function to a Logical Unit, the response of the Logical Unit are the same as the response to a TARGET RESET task management function.

B.3.4 Device Reset

There are two possible Device Reset alternatives, ABORT TASK SET and CLEAR TASK SET. The ABORT TASK SET is mandatory for all SCSI Logical Units. SCSI Logical Units that do not support tagged tasks may support CLEAR TASK SET.

CLEAR TASK SET is different from ABORT TASK SET in that CLEAR TASK SET clears all of the queued tasks for all Initiators. If the Logical Unit is in a single Initiator environment, ABORT and CLEAR TASK SET functions in the same manner.

The ABORT/CLEAR TASK SET:

- Does not immediately reset SCSI bus protocol.
- Does not reset parameters in mode page to default values
- Always keep the disc information such as disc TOC information
- Does not change the Persistent Prevent state

B.3.5 Power Management and Device Reset in SCSI

When a SCSI Device is in the Power Managed Sleep state, a reset through the service delivery subsystem are used to wake the device.

B.3.6 Mapping of reset functions

Table B.1 shows how the different reset functions specified in the various ATAPI specifications are used in this standard. This table is not intended to show all possible resets or their mapping.

Table B.1 – Example Reset Function Mapping in SCSI

Reset Type	SCSI
Power-On Reset	Same as Power-On Reset
Hard Reset	TARGET RESET task management function
	SAM Reset events – SCSI protocol dependent.
	SPI Reset Signal
Device Reset	TARGET RESET

Annex C Implementation Notes: SCSI Serial Bus Protocol (Informative)

C.1 SBP-2 Definitions

C.1.1 Command block

Space reserved within an ORB to describe a command intended for a Logical Unit that controls device functions or the transfer of data to or from device medium.

C.1.2 IEEE 1394

IEEE 1394 is understood as a reference to IEEE Std 1394-1995 as amended by IEEE Std 1394a-2000.

C.1.3 login

The process by which an Initiator obtains access to a set of device fetch agents. The device fetch agents and their control and status registers provide a mechanism for an Initiator to signal ORB's to the device.

C.1.4 quadlet

Four bytes, or 32 bits, of data.

C.1.5 register

A term used to describe quadlet aligned addresses that may be read or written by IEEE 1394 transactions. In the context of this standard, the use of the term register does not imply a specific hardware implementation. e.g., a processor may emulate the behavior of registers.

C.1.6 status block

A data structure written to system memory by a device when an operation request block has been completed.

C.1.7 system memory

The portion of any node's memory that is directly addressable by a IEEE 1394 address and that accepts, at a minimum, quadlet read and write access. Computers are the most common example of nodes that make system memory addressable from IEEE 1394, but any node, including those usually thought of as peripheral devices, may have system memory.

C.1.8 transaction

An exchange between a requester and a responder that consists of a request and a response sub-action is a transaction. The request sub-action transmits a IEEE 1394 transaction such as quadlet read, block write or lock, from the requesting node to the node intended to respond. Some IEEE 1394 commands include data as well as transaction codes. The response sub-action returns completion status and sometimes data from the responding node to the requesting node.

C.1.9 unit

A component of a IEEE 1394 node that provides processing, memory, I/O or some other functionality. Once the node is initialized, the unit provides a CSR interface that is typically accessed by device driver software at an Initiator. A node may have multiple units that normally operate independently of each other. Within this standard, a unit is equivalent to a device.

C.1.10 unit architecture

The specification of the interface to and the services provided by a unit implemented within an IEEE 1394 node.

C.1.11 unit attention

A state that a Logical Unit maintains while it has unsolicited status information to report to one or more logged-in Initiators. A unit attention condition is created as described elsewhere in this standard

or in the applicable command set- and device-dependent documents.

C.2 SBP-2 Storage Model

C.2.1 Overview

The SBP-2 Storage Model describes general characteristics and functions of MM Logical Units when implemented using SBP-2. It is intended to provide design information and lead to a better understanding of MM Logical Unit functionality.

C.2.2 Model configuration

This configuration is used only as an example of a common implementation. The following assumptions are made for this model configuration.

- The device supports a single Logical Unit.
- The device does not support multiple Initiators.
- The device does not support isochronous data transfers.

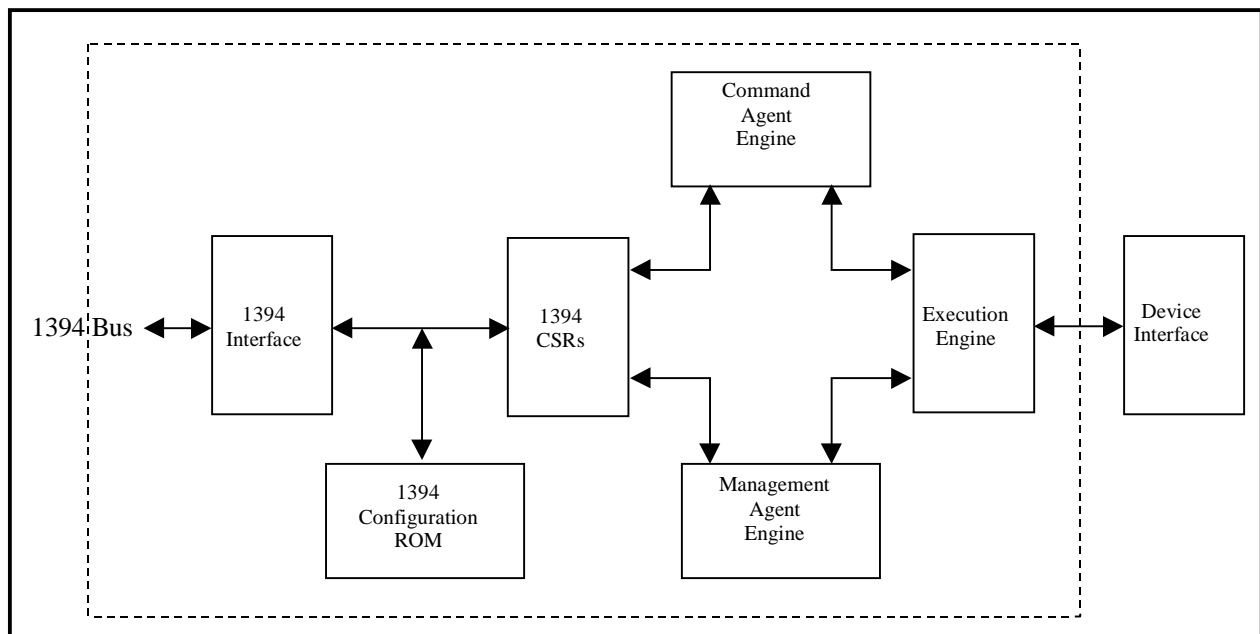

Figure C.1 – Mass storage interface block diagram

C.2.3 Model operation

The block diagram in Figure C.1 indicates the functional blocks contained in an MM device that supports SBP-2. This section describes the function of those blocks when processing a list of ORBs. The ORBs contain READ commands in this example.

After power-on or bus reset, the Command_Agent and Management_Agent engines are in the Reset state.

The Initiator reads the MM device's Configuration ROM data in order to determine its 1394 capabilities, SBP-2 capabilities, EUI-64 value, command set identifiers, software versions, and Management_Agent CSR address.

The Initiator performs a Login operation prior to any request to the MMC2 device. To perform a Login, the Initiator writes its Login ORB address to the Management_Agent register. The Login ORB should contain either the current or master password for the Login to be successful. The MM device returns the Login response to the bus address specified in the Login ORB. One field of the Login response contains the Command_Agent's CSR base address.

Prior to initiating command transfers, the Initiator builds a list of Command_Block ORBs in system memory. The list may be as short as one ORB, but this example assumes a list length of more than one. The last ORB in the list contains a NULL Next_ORB pointer that indicates the end of the list to the MM device's Command_Agent fetch engine.

To transition the Command_Agent state from Reset to Active the Initiator writes the offset of the first ORB in the ORB list to the MM device's ORB_Pointer CSR address. This allows the Command_Agent fetch engine to begin fetching ORBs from Initiator memory. If the Initiator writes to the Doorbell CSR, the MM device ignores the Doorbell at this time.

The MM device fetches ORBs until its ORB space is full or until an ORB containing a NULL Next_ORB pointer is fetched. Fetched ORBs are routed to the Execution engine. The Execution engine may reorder the commands contained in the ORBs for best performance.

As each READ command is processed the MM device transfers READ data to the Initiator's memory space via block write requests.

Following the data transfer portion of each command the MM device writes a Status_Block to the Initiator's Status_FIFO address. The Status_FIFO address for Command Block ORBs is contained in the Login_ORB. The status block contains SBP-2 specific command information, such as the ORB_offset of the Command_Block ORB associated with this status, as well as general sense information.

NOTE 35: ORBs contain a NOTIFY bit that is to be set if a Status_Block is to be written to Initiator memory after every ORB is processed or cleared if a Status_Block is to be written only after ORB execution encounters an error. This bit is advisory only. MM Logical Units return a Status_Block for all ORBs processed.

If an ORB containing a Null Next_ORB pointer is fetched the Execution engine completes all fetched commands, including the one in the just fetched ORB, before the Command_Agent transitions to the Suspended state.

If additional commands are to be processed, the Initiator creates a new list of Command_Block ORBs; changes the Next_ORB pointer in the last ORB of the old list from NULL to the offset of the first ORB in the new list; then writes to the MM device's Doorbell CSR address. This transitions the Command_Agent to the Active state.

The MM device fetches the new Next_ORB pointer value from the last ORB of the old list and begins fetching ORBS from the new list at that offset.

If the Command_Agent fetch engine has not reached the ORB containing a Null Next_ORB pointer (and is still in the Active state), the MM device ignores any writes to the Doorbell CSR address.

This sequence may continue until the MM device is reset, power is removed, or an error occurs.

C.2.4 Reconnect /Power reset support (normative)

MM Logical Units support the Reconnect management function following a bus reset, as described in SBP-2. However, in the case that a Reconnect request occurs following a power reset, MM Logical Units perform as follows:

1. Following a power reset, any previous login information is discarded and the device then transitions to the Reset state.
2. If an Initiator sends a Reconnect ORB to the device, the device returns status with RESP set to 0, REQUEST COMPLETE, and sbp_status set to A₁₆, LOGIN ID NOT RECOGNIZED.

C.3 Configuration ROM support (normative)

C.3.1 Overview

Although most Configuration ROM entries are generic, several contain information that is specific to each device type. Hard disk Logical Unit specific Configuration ROM information is defined in this section.

C.3.2 Unit Directory – Command_Set_Spec_ID

The COMMAND_SET_SPEC_ID entry (key – 38₁₆) is an immediate entry that specifies the organization responsible for the command set definition for the device. SCSI targets have a

COMMAND_SET_SPEC_ID of 00 609Eh that indicates that INCITS is responsible for the command set definition.

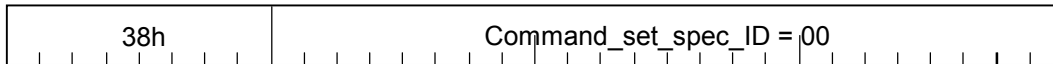

C.3.3 Unit Directory – Command_Set

The COMMAND_SET_ENTRY (key – 39h) is an immediate entry that, in combination with the COMMAND_SET_SPEC_ID entry specifies the command set supported by the unit. SCSI targets have a command_set value of 01 04D8h that indicates that the target’s command set is specified by SCSI Primary Commands - 2 (SPC-3) and related command set standard(s), as determined by the targets peripheral device type(s).



C.3.4 Unit Directory – Command_Set_Revision

The COMMAND_SET_REVISION entry (key – 3Bh) is an immediate entry that specifies the current revision level of the command set implemented by the unit.

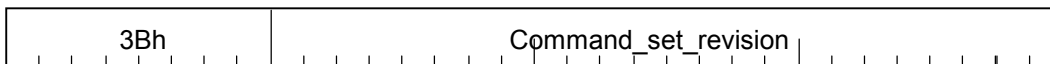

C.3.5 Unit Directory – Logical_Unit_Number

The LOGICAL_UNIT_NUMBER entry (key – 14h) is an immediate entry that specifies the device type and the Logical Unit number of a Logical Unit supported by the device. The format of this entry is defined in SBP-2 and duplicated here with additional field information for hard disk drives.

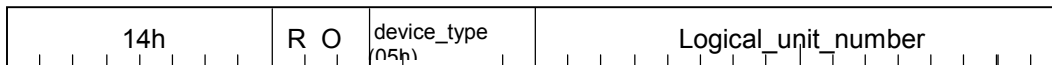

R in the figure above indicates reserved bits.

The ordered bit (abbreviated as O in the figure above) specifies the manner in which the Logical Unit processes tasks signaled to the command block agent. If the Logical Unit processes and reports completion status without any ordering constraints, the ordered bit is zero. Otherwise, if the Logical Unit both processes all tasks in order and reports their completion status in the same order, the ordered bit is one.

The Device_Type field indicates the peripheral device type implemented by the Logical Unit. The value defined for MM Logical Units is 05h.

Logical_Unit_Number field identifies the Logical Unit to which the information in the LOGICAL_UNIT_NUMBER entry applies.

C.4 Login support (normative)

MM Logical Units implement the Login support as defined in SBP-2.

C.5 Security support (normative)

MM Logical Units implement security against unauthorized media access as defined in the security annex of SBP-2.

The master password, referenced in SBP-2, is contained in the INQUIRY command, Vital Product Data, page 80h. Following a successful Login operation, the Initiator requests that the Logical Unit perform the INQUIRY command, in order to obtain the Logical Unit’s serial number.

C.6 Status block support (normative)

The status block for MM Logical Units is implemented as described in the following text and figure. Refer to SBP-2, Annex B, for a complete description of all bits and fields.

If no exception status is generated, only the first two quadlets (LEN =1) is written to the Initiator’s

STATUS_FIFO address.

If exception status is generated, the device writes, at a minimum, the four quadlets (len = 2) shown below. This format is required for unsolicited status as well as command status.

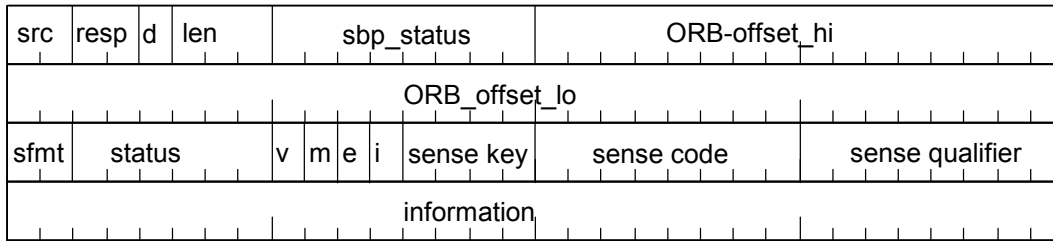

C.7 Unsolicited Status support (normative)

MM Logical Units that support the SBP-2 transport protocol implements the generation of unsolicited status. Devices notify Initiators of unsolicited status support by setting the ASYNCHRONOUS EVENT REPORTING CAPABILITY (AERC) bit to one in the standard data format of the INQUIRY command (see SPC-3)

As stated in SBP-2, unsolicited status is enabled when the Initiator writes to the Unsolicited_Status_Enable CSR. Devices default to unsolicited status disabled and only send unsolicited status following a write to the Unsolicited_Status_Enable CSR. The Unsolicited_Status_Enable CSR is a handshake mechanism and is written after every unsolicited status event in order to enable another such event.

C.8 Unit attention condition

A unit attention condition persists for a logged-in Initiator until

- a) unsolicited status, that reports the unit attention condition, is successfully written to the Initiator’s status FIFO address, or
- b) the Initiator’s login becomes invalid or is released. Logical Units may queue unit attention conditions; more than one unit attention condition may exist at the same time.

**This page is intentionally
blank.**

Annex D Implementation Notes: Universal Serial Bus (Informative)

D.1 USB and Mass Storage Definitions

D.1.1 Bulk Transfer

This is one of the four USB transfer types. A Bulk transfer:

- is non-periodic, large “bursty” communication,
- is able to use all undedicated bandwidth,
- may be delayed until bandwidth is available.

D.1.2 Capabilities

Those attributes of a USB device that are administrated by the Initiator.

D.1.3 Characteristics

Those qualities of a USB device that are unchangeable between resets; e.g., the device class is a device characteristic.

D.1.4 Command Block Wrapper (CBW)

The CBW is a data structure containing a command block and associated information.

D.1.5 Command Status Wrapper (CSW)

The CSW is a data structure containing the status of a command block.

D.1.6 Control Endpoint

A control endpoint is a pair of device endpoints with the same endpoint number that are used by a control message pipe. Control endpoints transfer data in both directions and, therefore, use both endpoint directions of a device address and endpoint number combination. Thus, each control endpoint consumes two endpoint addresses.

D.1.7 Data-In

Indicates a transfer of data IN from the device to the Initiator.

D.1.8 Data-Out

Indicates a transfer of data OUT from the Initiator to the device.

D.1.9 Default Pipe

The message pipe created by the USB System Software to pass control and status information between the Initiator and a USB device’s endpoint zero.

D.1.10 Device

With reference to USB, a device is either a logical or physical entity that performs a function. The actual entity described depends on the context of the reference. At the lowest level, device may refer to a single hardware component, as in a memory device. At a higher level, it may refer to a collection of hardware components that perform a particular function, such as a USB interface device. At an even higher level, device may refer to the function performed by an entity attached to the USB; e.g., a data/FAX modem device. Devices may be physical, electrical, addressable, and logical. When used as a non-specific reference, a USB device is either a hub or a function.

D.1.11 Device Endpoint

The Device Endpoint is a uniquely addressable portion of a USB device that is the source or sink of information in a communication flow between the Initiator and device.

D.1.12 Device Request

Requests from the Initiator to the device using the default pipe.

D.1.13 Endpoint

An endpoint that is capable of consuming an isochronous data stream that is sent by the Initiator.

D.1.14 Endpoint Number

A four-bit value between 0H and FH, inclusive, associated with an endpoint on a USB device.

D.1.15 Message Pipe

A bi-directional pipe that transfers data using a request/data/status paradigm. The data has an imposed structure that allows requests to be reliably identified and communicated.

D.1.16 NAK

This is an abbreviation for negative acknowledgment.

D.1.17 Packet

A bundle of data organized in a group for transmission. Packets typically contain three elements: control information (e.g., source, destination, and length), the data to be transferred, and error detection and correction bits.

D.1.18 Phase

This is a token, data, or handshake packet. A transaction has three phases.

D.1.19 Phase Error

An error returned by the device indicating that the results of processing further CBWs is indeterminate until the device is reset.

D.1.20 Pipe

A pipe is a logical abstraction representing the association between an endpoint on a device and software on the Initiator. A pipe has several attributes; e.g., a pipe may transfer data as streams (stream pipe) or messages (message pipe). See also stream pipe and message pipe. Port Point of access to or from a system or circuit. For the USB, this is the point where a USB device is attached.

D.1.21 Port

A Port is the point of access to or from a system or circuit. For the USB, this is the point where a USB device is attached.

D.1.22 Processed

Data received and controlled internally by the device to the point that the Initiator need no longer be concerned about it.

D.1.23 Protocol

A specific set of rules, procedures, or conventions relating to format and timing of data transmission between two devices.

D.1.24 Relevant

The amount of the data copied in to the Initiator by the device that is significant.

D.1.25 Request

A request made to a USB device contained within the data portion of a SETUP packet.

D.1.26 Reset Recovery

This is an error recovery procedure by which the Initiator prepares the device for further CBWs.

D.1.27 Thin Diagonal

Cases where the Initiator and device are in complete agreement about how many bytes of data to copy in which direction.

D.1.28 Transaction

The delivery of service to an endpoint; consists of a token packet, optional data packet, and optional handshake packet. Specific packets are allowed/required based on the transaction type.

D.1.29 Transfer

One or more bus transactions to move information between a software client and its function.

D.1.30 USB-IF

USB Implementers Forum, Inc. is a nonprofit corporation formed to facilitate the development of USB compliant products and promote the technology. www.usb.org

D.2 Bulk Only Mass Storage

D.2.1 Scope

This normative only covers the Bulk-Only Transport. The complete *USB Mass Storage Class Specification* that covers the Bulk-Only Transport is available at www.usb.org. The CBI (Control/Bulk/Interrupt) transport is used for Full Speed Floppy devices.

D.2.2 Bulk-Only Mass Storage Reset (class-specific request)

This request is used to reset the mass storage device and its associated interface. This class-specific request makes the device ready for the next CBW from the Initiator.

The Initiator sends this request via the default pipe to the device. The device preserves the value of its bulk data toggle bits and endpoint STALL conditions despite the Bulk-Only Mass Storage Reset.

The device NAKs the status stage of the device request until the Bulk-Only Mass Storage Reset is complete.

To issue the Bulk-Only Mass Storage Reset the Initiator issues a device request on the default pipe of:

- bmRequestType: Class, Interface, Initiator to device
- bRequest field set to 255 (FFh)
- wValue field set to 0
- wIndex field set to the interface number
- wLength field set to 0

Table D.1 – Bulk-Only Mass Storage Reset

bmRequestType	bRequest	wValue	wIndex	wLength	Data
00100001b	11111111b	0000h	Interface	0000h	none

D.2.3 Get Max LUN (class-specific request)

The device may implement several logical units that share common device characteristics. The Initiator uses bCBWLUN to designate the logical unit of the device that is the destination of the CBW. The Get Max LUN device request is used to determine the number of logical units supported by the device. Logical Unit Numbers on the device is numbered contiguously starting from LUN 0 to a maximum LUN of 15 (Fh).

To issue a Get Max LUN device request, the Initiator issues a device request on the default pipe of:

- bmRequestType: Class, Interface, device to Initiator
- bRequest field set to 254 (Feh)
- wValue field set to 0
- wIndex field set to the interface number
- wLength field set to 1

Table D.2 – Get Max LUN

bmRequestType	bRequest	wValue	wIndex	wLength	Data
10100001b	11111110b	0000h	Interface	0001h	1 byte

The device returns one byte of data that contains the maximum LUN supported by the device. If no LUN is associated with the device, the value returned is 0. The Initiator does not send a command block wrapper (CBW) to a non-existing LUN.

Devices that do not support multiple LUNs may STALL this command.

D.2.4 Initiator/Device Packet Transfer Order

The Initiator sends the CBW before the associated Data-Out, and the device sends Data-In after the associated CBW and before the associated CSW. The Initiator may request Data-In or CSW before sending the associated CBW.

If the dCBWDataTransferLength is zero, the device and the Initiator transfers no data between the CBW and the associated CSW.

D.2.5 Command Queuing

The Initiator does not transfer a CBW to the device until the Initiator has received the CSW for any outstanding CBW. If the Initiator issues two consecutive CBWs without an intervening CSW or reset, the device response to the second CBW is indeterminate.

D.2.6 Standard Descriptors

The device supports the following standard USB descriptors:

- a. **Device.** Each USB device has one device descriptor (per *USB Specification*).
- b. **Configuration.** Each USB device has one default configuration descriptor that supports at least one interface.
- c. **Interface.** The device supports at least one interface, known herein as the Bulk-Only Data Interface. Some devices may support additional interfaces, to provide other capabilities.
- d. **Endpoint.** The device supports the following endpoints, in addition to the default pipe that is required of all USB devices:
 1. Bulk-In endpoint
 2. Bulk-Out endpoint
 3. Some devices may support additional endpoints, to provide other capabilities. The Initiator uses the first reported Bulk-In and Bulk-Out endpoints for the selected interface.
- e. **String.** The device supplies a unique serial number.

D.2.7 Device Descriptor

Each USB device has one device descriptor (per *USB Specification*). The device specifies the device class and subclass codes in the interface descriptor, and not in the device descriptor.

Table D.3 – Device Descriptor

Offset	Field	Size	Value	Description
0	bLength	Byte	12h	Size of this descriptor in bytes.
1	bDescriptorType	Byte	01h	DEVICE descriptor type.
2	bcdUSB	Word	xxxxh	<i>USB Specification</i> Release Number in Binary-Coded Decimal (i.e., 2.10 = 210h). This field identifies the release of the <i>USB Specification</i> with which the device and its descriptors are compliant.
4	bDeviceClass	Byte	00h	Class code (assigned by the USB-IF).
5	bDeviceSubClass	Byte	00h	Subclass code (assigned by the USB-IF).
6	bDeviceProtocol	Byte	00h	Protocol code (assigned by the USB-IF).
7	bMaxPacketSize0	Byte	xxh	Maximum packet size for endpoint zero. (only 8, 16, 32, or 64 are valid (08h, 10h, 20h, 40h)).
8	idVendor	Word	xxxxh	Vendor ID (assigned by the USB-IF).
10	idProduct	Word	xxxxh	Product ID (assigned by the manufacturer).
12	bcdDevice	Word	xxxxh	Device release number in binary-coded decimal.
14	iManufacturer	Byte	xxh	Index of string descriptor describing the manufacturer.
15	iProduct	Byte	xxh	Index of string descriptor describing this product.
16	iSerialNumber	Byte	xxh	Index of string descriptor describing the device's serial number.
17	bNumConfigurations	Byte	xxh	Number of possible configurations.

D.2.8 Serial Number

The *iSerialNumber* field is set to the index of the string descriptor that contains the serial number. The serial number contains at least 12 valid digits, represented as a UNICODE string. The last 12 digits of the serial number is unique to each USB *idVendor* and *idProduct* pair.

The Initiator may generate a globally unique identifier by concatenating the 16-bit *idVendor*, the 16 bit *idProduct* and the value represented by the last 12 characters of the string descriptor indexed by *iSerialNumber*.

The field *iSerialNumber* is an index to a string descriptor and does not contain the string itself.

D.2.9 Valid Serial Number Characters

Numeric numbers 0030h through 0039h that represent ASCII "0" through "9" and 0041h through 0046h as ASCII "A" through "F".

D.3 Descriptors

D.3.1 Configuration Descriptor

Table D.4 – Configuration Descriptor

Offset	Field	Size	Value	Description										
0	bLength	Byte	09h	Size of this descriptor in bytes.										
1	bDescriptorType	Byte	02h	CONFIGURATION Descriptor Type.										
2	wTotalLength	Word	xxxxh	Total length of data returned for this configuration. Includes the combined length of all descriptors (configuration, interface, endpoint, and class- or vendor-specific) returned for this configuration.										
4	bNumInterfaces	Byte	xxh	Number of interfaces supported by this configuration. The device supports at least the Bulk-Only Data Interface.										
5	bConfigurationValue	Byte	xxh	Value to use as an argument to the SetConfiguration() request to select this configuration.										
6	iConfiguration	Byte	xxh	Index of string descriptor describing this configuration.										
7	bmAttributes	Byte	x0h	Configuration characteristics: <table border="0" style="margin-left: 20px;"> <thead> <tr> <th>Bit</th> <th>Description</th> </tr> </thead> <tbody> <tr> <td>7</td> <td>Reserved (set to one)</td> </tr> <tr> <td>6</td> <td>Self-powered</td> </tr> <tr> <td>5</td> <td>Remote Wakeup</td> </tr> <tr> <td>4..0</td> <td>Reserved (reset to zero)</td> </tr> </tbody> </table> Bit 7 is reserved and is set to one for historical reasons.	Bit	Description	7	Reserved (set to one)	6	Self-powered	5	Remote Wakeup	4..0	Reserved (reset to zero)
Bit	Description													
7	Reserved (set to one)													
6	Self-powered													
5	Remote Wakeup													
4..0	Reserved (reset to zero)													
8	MaxPower	Byte	xxh	Maximum power consumption of the USB device from the bus in this specific configuration when the device is fully operational. Expressed in 2mA units (i.e., 50 = 100mA)										

D.3.2 Interface Descriptor

The device supports at least one interface, known herein as the Bulk-Only Data Interface. The Bulk-Only Data Interface uses three endpoints.

Composite mass storage devices may support additional interfaces, to provide other features such as audio or video capabilities. This specification does not define such interfaces.

The interface may have multiple alternate settings. The Initiator examines each of the alternate settings to look for the bInterfaceProtocol and bInterfaceSubClass it supports optimally.

Table D.5 – Bulk-Only Data Interface Descriptor

Offset	Field	Size	Value	Description
0	bLength	Byte	09h	Size of this descriptor in bytes.
1	bDescriptorType	Byte	04h	INTERFACE Descriptor Type.
2	bInterfaceNumber	Byte	0xh	Number of interface. Zero-based value identifying the index in the array of concurrent interfaces supported by this configuration.
3	bAlternateSetting	Byte	xxh	Value used to select alternate setting for the interface identified in the prior field.
4	bNumEndpoints	Byte	xxh	Number of endpoints used by this interface (excluding endpoint zero). This value is at least 2.
5	bInterfaceClass	Byte	08h	MASS STORAGE Class.
6	bInterfaceSubClass	Byte	0xh	Subclass code (assigned by the USB-IF). Indicates the industry standard command block definition to use. Does not specify a type of storage device such as a floppy disk or CD-ROM drive.
7	bInterfaceProtocol	Byte	50h	BULK-ONLY TRANSPORT.
8	iInterface	Byte	xxh	Index to string descriptor describing this interface.

D.3.3 Endpoint Descriptors

The device supports at least three endpoints: Control, Bulk-In and Bulk-Out.

Each USB device defines a Control endpoint (Endpoint 0). This is the default endpoint and does not require a descriptor.

D.3.4 Bulk-In Endpoint

The Bulk-In endpoint is used for transferring data and status from the device to the Initiator.

Table D.6 – Bulk-In Endpoint Descriptor

Offset	Field	Size	Value	Description								
0	bLength	Byte	07h	Size of this descriptor in bytes.								
1	bDescriptorType	Byte	05h	ENDPOINT Descriptor Type.								
2	bEndpointAddress	Byte	xxh	The address of this endpoint on the USB device. The address is encoded as follows. <table border="1" data-bbox="844 1333 1177 1449"> <thead> <tr> <th>Bit</th> <th>Description</th> </tr> </thead> <tbody> <tr> <td>3..0</td> <td>The endpoint number</td> </tr> <tr> <td>6..4</td> <td>Reserved, set to 0</td> </tr> <tr> <td>7</td> <td>1 = In</td> </tr> </tbody> </table>	Bit	Description	3..0	The endpoint number	6..4	Reserved, set to 0	7	1 = In
Bit	Description											
3..0	The endpoint number											
6..4	Reserved, set to 0											
7	1 = In											
3	bmAttributes	Byte	02h	This is a Bulk endpoint.								
4	wMaxPacketSize	Word	00xxh	Maximum packet size. Is 8, 16, 32 or 64 decimal bytes.								
6	bInterval	Byte	00h	Does not apply to Bulk endpoints.								

D.3.5 Bulk-Out Endpoint

The Bulk-Out endpoint is used for transferring command and data from the Initiator to the device.

Table D.7 – Bulk-Out Endpoint Descriptor

Offset	Field	Size	Value	Description								
0	bLength	Byte	07h	Size of this descriptor in bytes.								
1	bDescriptorType	Byte	05h	ENDPOINT descriptor type.								
2	bEndpointAddress	Byte	0xh	The address of this endpoint on the USB device. This address is encoded as follows: <table border="0" style="margin-left: 40px;"> <thead> <tr> <th style="text-align: left;">Bit</th> <th style="text-align: left;">Description</th> </tr> </thead> <tbody> <tr> <td>3..0</td> <td>Endpoint number</td> </tr> <tr> <td>6..4</td> <td>Reserved, set to 0</td> </tr> <tr> <td>7</td> <td>0 = Out</td> </tr> </tbody> </table>	Bit	Description	3..0	Endpoint number	6..4	Reserved, set to 0	7	0 = Out
Bit	Description											
3..0	Endpoint number											
6..4	Reserved, set to 0											
7	0 = Out											
3	bmAttributes	Byte	02h	This is a Bulk endpoint.								
4	wMaxPacketSize	Word	00xxh	Maximum packet size. Is 8, 16, 32 or 64 decimal bytes.								
6	bInterval	Byte	00h	Does not apply to Bulk endpoints.								

D.4 Command/Data/Status Protocol

D.4.1 Command Block Wrapper (CBW)

The CBW starts on a packet boundary and ends as a short packet with exactly 31 (1Fh) bytes transferred. Fields appear aligned to byte offsets equal to a multiple of their byte size. All subsequent data and the CSW start at a new packet boundary. All CBW transfers are ordered with the LSB (byte 0) first (little endian).

Table D.8 – Command Block Wrapper

Bit	7	6	5	4	3	2	1	0	
Byte									
0	(LSB) dCBWSignature (MSB)								
...									
3									
4	(LSB) dCBWTag (MSB)								
...									
7									
8	(LSB) dCBWDataTransferLength (MSB)								
...									
11									
12	bmCBWFlags								
	Direction	Obsolete	Reserved						
13	Reserved				bCBWLUN				
14	Reserved			bCBWCBLength					
15	CBWCB								
...									
30									

The dCBWSignature field helps identify this data packet as a CBW. The signature field contains the value 43425355h (little endian), indicating a CBW.

The dCBWTag field is a Command Block Tag sent by the Initiator. The device echos the contents of this field back to the Initiator in the dCSWTag field of the associated CSW. The dCSWTag positively associates a CSW with the corresponding CBW.

The dCBWDataTransferLength field is the number of bytes of data that the Initiator expects to transfer on the Bulk-In or Bulk-Out endpoint (as indicated by the Direction bit) during the execution of this command. If this field is zero, the device and the Initiator transfers no data between the CBW and the associated CSW, and the device ignores the value of the Direction bit in bmCBWFlags.

The bmCBWFlags field is bit significant:

Direction - the device ignores this bit if the dCBWDataTransferLength field is zero, otherwise:

- 0 = Data-Out from Initiator to the device,
- 1 = Data-In from the device to the Initiator.

The bCBWLUN field contains the device Logical Unit Number (LUN) to which the command block is being sent. For devices that support multiple LUNs, the Initiator places into this field the LUN to which this command block is addressed. Otherwise, the Initiator sets this field to zero.

The bCBWCBLength field contains the valid length of the CBWCB field in bytes. The only legal values are 1 through 16 (01h through 10h). All other values are reserved.

The CBWCB field is the command block to be processed by the device. The device interprets the first bCBWCBLength bytes in this field as a command block as defined by the command set identified by bInterfaceSubClass. If the command set supported by the device uses command blocks of fewer than 16 (10h) bytes in length, the significant bytes are transferred first, beginning with the byte at

offset 15 (Fh). The device ignores the content of the CBWCB field past the byte at offset (15 + bCBWCBLength – 1).

D.4.2 Command Status Wrapper (CSW)

The CSW starts on a packet boundary and ends as a short packet with exactly 13 (0Dh) bytes transferred. Fields appear aligned to byte offsets equal to a multiple of their byte size. All CSW transfers are ordered with the LSB (byte 0) first (little endian).

Table D.9 – Command Status Wrapper

Bit	7	6	5	4	3	2	1	0
Byte								
0	(LSB) dCSWSignature (MSB)							
...								
3								
4	(LSB) dCSWTag (MSB)							
...								
7								
8	(LSB) dCSWDataResidue (MSB)							
...								
11								
12	bmCSWStatus							

The dCSWSignature field contains the value 53425355h (little endian), indicating CSW.

The dCSWTag is set to the value received in the dCBWTag of the associated CBW.

The dCSWDataResidue field definition is dependent upon the data direction of the associated CBW. For Data-Out the dCSWDataResidue contains the difference between the amount of data expected as stated in the dCBWDataTransferLength, and the actual amount of data processed by the device. For Data-In the dCSWDataResidue contains the difference between the amount of data expected as stated in the dCBWDataTransferLength and the actual amount of relevant data sent by the device. The dCSWDataResidue does not exceed the value sent in the dCBWDataTransferLength.

The bCSWStatus field contains the ending status of the command. The device sets this byte to zero if the command completed successfully. A non-zero value indicates a failure during command execution according to the following table:

Table D.10 – Command Block Status Values

Value	Description
00h	Command Passed (“good status”)
01h	Command Failed
02h	Phase Error
03h and 04h	Reserved
05h to FFh	Reserved

D.5 Data Transfer Conditions

This sub-clause describes how the Initiator and device remain synchronized.

The Initiator indicates the expected transfer in the CBW using the Direction bit and the `dCBWDataTransferLength` field. The device then determines the actual direction and data transfer length. The device responds by transferring data, STALLing endpoints when specified, and returning the appropriate CSW.

D.5.1 Command Transport

The Initiator sends each CBW that contains a command block, to the device via the Bulk-Out endpoint. The CBW starts on a packet boundary and ends as a short packet with exactly 31 (1Fh) bytes transferred.

The device indicates a successful transport of a CBW by accepting (ACKing) the CBW. If the Initiator detects a STALL of the Bulk-Out endpoint during command transport, the Initiator responds with a Reset Recovery.

D.5.2 Data Transport

All data transport begins on a packet boundary. The Initiator attempts to transfer the exact number of bytes to or from the device as specified by the `dCBWDataTransferLength` and the Direction bit.

To report an error before data transport completes and to maximize data integrity, the device may terminate the command by STALLing the endpoint in use (the Bulk-In endpoint during data in, the Bulk-Out endpoint during data out).

D.5.3 Status Transport

The device sends each CSW to the Initiator via the Bulk-In endpoint. The CSW starts on a packet boundary and ends as a short packet with exactly 13 (Dh) bytes transferred.

The CSW indicates to the Initiator the status of the execution of the command block from the corresponding CBW. The `dCSWDataResidue` field indicates how much of the data transferred is to be considered processed or relevant. The initiator ignores any data beyond the number of bytes specified by the `dCSWDataResidue` field.

D.5.4 Phase Error

The Initiator performs a Reset Recovery when Phase Error status is returned in the CSW.

D.5.5 Reset Recovery

For Reset Recovery the Initiator issues in the following order :

- 1) a Bulk-Only Mass Storage Reset
- 2) a Clear Feature HALT to the Bulk-In endpoint
- 3) a Clear Feature HALT to the Bulk-Out endpoint

D.5.6 The 13 Cases

The Initiator software that decides the CBWCB owns the job of making sure the device's interpretation of the CBWCB agrees with `bmCBWFlags`. Direction and `dCBWDataTransferLength`.

Usb Mass, if implemented as specified, works even if the Initiator software fails to deliver this guarantee, but then the details are complex. See section '6.7 The Thirteen Cases' in the full *USB Mass Storage Class Specification*.

Annex E Legacy Specifications (Normative)

E.1 Overview

There are commands, command options, mode pages, and fields within structures defined in earlier standards that are not recommended for use in multi-media devices. Due to the prevalence of installed systems that require continued use of these capabilities, the formal path of obsolescence may have undesirable results. For this reason, MMC preserves these definitions in this annex. These specifications are unchanged from their former state in previous standards.

If a legacy method is implemented, the implementation should be according to the description found in this annex.

E.2 Commands

E.2.1 GET EVENT STATUS NOTIFICATION Command – Operational Change Events

When the Notification Class code in the Event Header is 001b, an Operational Change Event Descriptor (Table E.1) follows the header.

An Operational Change event indicates that the operational capabilities or parameters may have changed for this Logical Unit.

Table E.1 – Operational Change Event Descriptor

Bit	7	6	5	4	3	2	1	0
Byte								
0	Reserved				Event Code			
1	Persistent Prevented	Reserved			Operational Status			
2	(MSB) Operational Change (LSB)							
3								

Persistent Prevented bit reports the current state of the persistent prevent for the Logical Unit. See 5.3.4.

The Event Code (Table E.2) identifies the operational change.

Table E.2 – Event Codes For the Operational Change Class

Code	Status	Description
0h	NoChg	No changes in the Logical Unit Operational state
1h	Operational Change Request	An operational change has been requested and the change is in progress
2h	Logical Unit has changed Operational state	The Logical Unit has changed Operational state
3h – Fh	Reserved	Reserved

If a new Event occurs before an existing Event is reported to the Initiator, the new event should replace the old Event if the new Event has a higher Code than the old Event. Otherwise, the new Event should be deleted.

The Operational Status field (Table E.3) reports the device’s ability to respond to the Initiator.

Table E.3 – Operational Status

Code	Status	Description
0h	Available	The Logical Unit is ready for operation
1h	Temporarily busy	The Logical Unit is performing a task that should self-terminate
2h	Reservation	The Logical Unit is reserved by another Initiator.
3h – Fh	Reserved	Reserved

The Operational Change field (Table E.4) reports the source of the change. If this field contains a non-zero value, the Initiator should send a GET CONFIGURATION command in order to discover any configuration changes.

Table E.4 – Operational Change

Code	Event	Description
0h	NoChg	No changes in operational state requested or performed
1h	Feature Change	An unspecified event has changed Feature currency
2h	New Features	The Feature list may have added Current Features (No Features became non-Current)
3h	Reset	The Logical Unit has been reset or Power-on has I
4h	Firmware Changed	The Logical Unit’s Microcode may have changed
5h	Inquiry change	The Logical Unit’s identification information may have changed
6h – FFFFh	Reserved	

E.2.2 GET EVENT STATUS NOTIFICATION Command – Device Busy Events

Device Busy Events are used to notify the Initiator of commands that are executing but that require an abnormally long time to complete. Response data is defined in Table E.5 .

Table E.5 – Device Busy Event Descriptor

Bit	7	6	5	4	3	2	1	0
Byte								
0	Reserved				Device Busy Event			
1	Device Busy Status							
2	(MSB) Time							
3	(LSB)							

The Device Busy Event field code is defined in Table E.6 .

Table E.6 – Device Busy Event Format

Code	Event	Description
0h	NoChg	No command has timed out.
1h	Busy Event	A time-out has occurred
2h – Fh	Reserved	

The Device Busy Status byte is defined in Table E.7 .

Table E.7 – Device Busy Status Format

Code	Status	Description
0h	No Event	The Logical Unit is ready to accept any command.
1h	Power	The Logical Unit is in the process of waking up from a low-power state.
2h	Immediate	The Logical Unit is in the process of completing an earlier command.
3h	Deferred	The Logical Unit is in the process of completing a deferred operation.
4h – Fh	Reserved	

The Time field is the predicted amount of time remaining for the Logical Unit to become not busy, in units of 100ms.

This type of event is usable in two environments. The first is in a queued environment. The GET EVENT/STATUS NOTIFICATION command may be issued in a non-immediate mode prior to executing commands or in the immediate mode while commands are being processed. The second environment is where immediate commands and deferred writing are performed; this command may be issued in the immediate mode to obtain status. If a normal command is issued while the device is busy, this command is unable to be issued until the normal command completes. Therefore, if queuing is not used, the GET EVENT/STATUS NOTIFICATION command should precede any command that may time out.

If a GET EVENT/STATUS NOTIFICATION command with the Device Busy class bit set, is queued, the Logical Unit should complete the command after a time-out as defined in the time-out section has occurred. However, instead of generating a unit attention condition, the only action is to complete this command. If this event is to be used via polling in the immediate mode, the Logical Unit should disable the Logical Unit time-outs.

If Report Status Notification is not supported or not enabled, the Logical Unit should return CHECK CONDITION status and set SK/ASC/ASCQ values to ILLEGAL REQUEST/INVALID FIELD IN CDB.

If the IMMED bit is set to one, and there is no Event to report the command should return good status.

If the IMMED bit is set to zero (and the Logical Unit supports tagged command queuing) and there is NO event to report, the GET EVENT/STATUS NOTIFICATION command should be queued by the target until there is an Event to report.

If the IMMED bit is set to zero and the target does not support tagged command queuing, the target should return CHECK CONDITION and set SK/ASC/ASCQ values to ILLEGAL REQUEST/INVALID FIELD IN CDB.

E.2.3 FORMAT UNIT Command, Format Code = 111b

If the Format Code in the CDB is 111b the CD-RW Format Descriptor defined in Table E.8 should be sent. Use of this Format Code is defined only for CD-RW.

Table E.8 – CD-RW Format Descriptor

Byte	Bit	7	6	5	4	3	2	1	0
0		SESS	Grow	Reserved					
1		Reserved							
2		Reserved							
3		Reserved							
4	(MSB)	Format Size							
5									
6									
7									

If both the Grow and Session bits are set to zero the format operation should format (Format Size)

user data blocks. Format Size should be integrally divisible by the Packet Size field in the Write Parameters Mode Page. The first formatted user data block should be LBA 0. Existing information on the disc may be overwritten. After the format, a single session containing a single, fixed packet track exists on the medium.

If the Grow bit is set to zero and the Session bit is set to 1 the format operation should create a new session that contains (Format Size) user data blocks. Format Size should be integrally divisible by the Packet Size field in the Write Parameters Page. If the last session on the disc is not closed when this command is issued, a CHECK CONDITION status should be generated.

A Grow bit of 1 indicates that the final session should be “grown” to (Format Size) from its original size. This is accomplished by appending packets to the existing session, writing a new Lead-out, and updating the PMA and Lead-in to change the track size to reflect the new size. Data in existing packets should not be affected. If the Format Size is smaller than the existing size, a CHECK CONDITION status should be returned. The order of updating the PMA, Lead-in, Lead-out, and data area is not specified.

The session bit should be ignored when the Grow bit is set.

NOTE 36: It is strongly recommended that the IP bit in the Format Parameters Header be set to zero. It is strongly recommended that an Initialization Parameters Descriptor precede the Format Descriptor.

E.2.4 READ TOC/PMA/ATIP Command: CDB Format field definition

The Format field for the READ TOC/PMA/ATIP command (6.30) is a 4-bit field occupying bits 3 through 0 of byte 2 as shown in Table 435. An earlier version of the READ TOC/PMA/ATIP command defined the Format field as a 2-bit field that occupies bits 6 and 7 of byte 9 (see Table E.9)

Table E.9 – READ TOC/PMA/ATIP CDB - Legacy Version

Byte	Bit	7	6	5	4	3	2	1	0	
0	Operation Code (43h)									
1	Reserved							MSF	Reserved	
2	Reserved									
3	Reserved									
4	Reserved									
5	Reserved									
6	Starting Track/Session Number									
7	(MSB)	Allocation Length								
8									(LSB)	
9		Format			Control					

The value of the Format field (Table E.10) defines the returned data format.

Table E.10 – Format Field Values

Format Field	MSF Field	Track/Session Number	Description
00b	Valid	Valid as a Track Number	The Track/Session Number field specifies starting track number for which the data is returned. For multi-session discs, TOC data is returned for all sessions. Track number AAh is reported only for the Lead-out area of the last complete session.
01b	Valid	Ignored by Logical Unit	This format returns the first complete session number, last complete session number and last complete session starting address. In this format, the Track/Session Number field is reserved and should be set to 00h.
10b	Ignored by Logical Unit	Valid as a Session Number	This format returns all Q sub-code data in the Lead-In (TOC) areas starting from a session number as specified in the Track/Session Number field. In this mode, the Logical Unit should support Q Sub-channel POINT field value of A0h, A1h, A2h, Track numbers, B0h, B1h, B2h, B3h, B4h, C0h, and C1h. There is no defined LBA addressing and TIME bit should be set to one.
11b	Reserved		

A PC BIOS may require this CDB format for the CD boot process. It is recommended that Logical Units that support CD boot, should support both the older and newer CDB formats.

E.2.5 SEND EVENT Command

The SEND EVENT command requests the Logical Unit to process an event on behalf of the Initiator. Features associated with this command are listed in Table E.11 .

Table E.11 – Features Associated with the SEND EVENT Command

Feature Number	Feature Name	Command Requirement
0002h	Morphing, version 0	Mandatory when Event Class 3 is supported

The event should be one that the Initiator had received from an earlier GET EVENT STATUS NOTIFICATION command. If a Logical Unit has received a persistent prevent, it should report events via the GET EVENT STATUS NOTIFICATION command instead of processing them directly. When the Initiator receives such a request, it should complete any operations in progress and process the event by emulating the button's functionality via commands or by sending the event back to the Logical Unit using the SEND EVENT command.

The Media Status Class Events reported to the Initiator should not be returned to the Logical Unit using the SEND EVENT command. Only events of Class External Request (Class 3) should be sent via the SEND EVENT command.

The SEND EVENT CDB is defined in Table E.12 .

Table E.12 – SEND EVENT CDB

Byte	Bit	7	6	5	4	3	2	1	0
0		Operation Code (5Dh)							
1		Reserved			Reserved				IMMED
2		Reserved							
3		Reserved							
4		Reserved							
5		Reserved							
6		Reserved							
7		Reserved							
8	(MSB)	Parameter List Length							
9		(LSB)							

10	Reserved
11	Control Byte

An Immediate (IMMED) bit of one indicates that status should be returned as soon as the CDB has been validated. The actual operation specified by the Event Parameter should be processed after the status has been reported to the Initiator. The IMMED bit should be set to 1h.

The Parameter List Length field specifies the length in bytes of the Event parameter list that should be transferred from the Initiator to the Logical Unit after the CDB is transferred. A parameter list length of zero indicates that no data should be transferred. This condition should not be considered as an error.

If the Event parameter list length results in the truncation of Event parameter data, the Logical Unit should terminate the command with CHECK CONDITION status and set SK/ASC/ASCQ values to ILLEGAL REQUEST/PARAMETER LIST LENGTH ERROR.

The Logical Unit should terminate the command with CHECK CONDITION status and SK/ASC/ASCQ values are set to ILLEGAL REQUEST/INVALID FIELD IN PARAMETER LIST, and should not take any action directed by the event specified for the following conditions:

1. If the Initiator sets any unreserved field in the Event parameter header to an unsupported value.
2. If an Initiator sends an Event parameter list with a Event Data Length not equal to the length returned by the GET EVENT STATUS NOTIFICATION command for the specified event class.
3. If the Initiator sends an invalid value for any Event parameter.

Table E.13 – Event Parameter Header

Bit	7	6	5	4	3	2	1	0
Byte								
0	(MSB) Event Parameter Length							(LSB)
1								
2	Reserved	Reserved				Notification Class (1h)		
3	Reserved							

The Event Parameter Length field specifies the number of bytes that follow the Event Parameter Length field. Notification Class field specifies the class of Event being sent to the Logical Unit. This field should contain a 1h.

Table E.14 – Operational Change/Notification Parameter Data

Bit	7	6	5	4	3	2	1	0
Byte								
0	Reserved				Operational Event			
1	Persistent Prevented	Reserved			Operational Status			
2	(MSB) Operational Request Code							
3	(LSB)							

The Operational Event field indicates the type of operation to be performed.

Table E.15 – Operational Event Field

Code	Event	Description
0h	No Change (NoCHge)	No request should be processed by the Logical Unit
1h	Operational Change Request	Initiator requests Logical Unit to process the Operational Request
2h – Fh	Reserved	

The Persistent Prevented bit is reserved and should be ignored.

The Operational Status field is reserved and should be ignored. This field may contain the non-zero value reported to the Initiator.

Operational Change Code field contains the actual requested operation. See Table E.15 for code descriptions.

Recommended error reporting is listed in Table E.16 .

Table E.16 – Recommended errors for SEND EVENT Command

Error	Reference	May be Deferred
Unit Attention conditions	Table F.1	
CDB or parameter list validation errors	Table F.2	
Readiness errors	Table F.3	
Protocol errors	Table F.4	
General media access errors	Table F.5	√
Write errors	Table F.7	√
Hardware failures	Table F.8	√

E.3 MODE PARAMETERS

E.3.1 Block Descriptors

The block descriptor associated with the MODE SELECT and MODE SENSE commands allows block size specification for CD sectors. If a block descriptor is supported, then at least a block size of 2 048 should be supported. Other block sizes may be supported. Table E.17 shows the possibilities for the various block sizes. These block size definitions apply for READ (6), READ (10), READ (12), VERIFY (10) and VERIFY (12) commands.

Valid block sizes are shown in Table E.17 .

Table E.17 – Block Descriptor Block Sizes for Read

Bytes	Readable block types
512	Mode 1 or Mode 2 Form 1 sectors divided into four blocks each
2 048	Mode 1, Mode 2 Form1, (and DVD)
2056	Mode 2 Form 1 with sub-header. Equivalent to READ CD, Flag = 50h.
2 324	Mode 2 Form 2 with no sub-header. There is no mapping to READ CD, as the 4 spare bytes are not returned.
2 332	Mode 2, Form 1 or 2 data. The Logical Unit should operate as specified for 2 048 byte blocks except that both forms send 2 332 byte blocks. Form 1 blocks return the third layer ECC with the user data. There is no mapping to READ CD, as the 4 spare bytes are not returned.
2 336	Mode 2 data. The Logical Unit should operate as specified for 2 048 byte block lengths. This mode includes all data: Yellow Book Mode 2 sectors and Form 1 & 3. This is equivalent to READ CD, Flag = 58h.
2 340	All bytes except the synchronization field. Equivalent to READ CD, Flag = 78h.
2 352	Audio or raw blocks. The Logical Unit should operate as specified for 2 048 byte block lengths. A read of data mode sectors should return de-scrambled data. Equivalent to READ CD, Flag = F8h.
2 448 or 2 368	Audio or raw blocks with raw Sub-channel. The Logical Unit should not perform the data descrambling operation. Equivalent to READ CD, Flag = F8. Sub-channel data selection = 010b (2 448) or Sub-channel data selection = 001b (2 368).

E.3.2 CD Device Parameters Mode Page (Page 0Dh)

The CD Parameters page (Table E.18) specifies parameters that affect all CD-ROM data types.

Table E.18 – CD Parameters page

Byte	Bit	7	6	5	4	3	2	1	0
0		PS	Reserved	Page Code (0Dh)					
1		Parameter Length (06h)							
2		Reserved							
3		Reserved				Inactivity Timer Multiplier			
4	(MSB)	Number Of MSF – S Units Per MSF – M Unit							
5									
		(LSB)							
6	(MSB)	Number Of MSF – F Units Per MSF – S Unit							
7									
		(LSB)							

The Parameter Savable bit is defined in 7.1.4.1.

The inactivity timer multiplier value specifies the length of time that the Logical Unit should remain in the hold track state after completion of a seek or read operation (Table E.19).

Table E.19 – Inactivity timer multiplier values

Inactivity timer multiplier value	Minimum time in hold track state	Inactivity timer multiplier value	Minimum time in hold track state
0	Vendor-specific	8	16 s
1	125 ms	9	32 s
2	250 ms	Ah	1 min.
3	500 ms	Bh	2 min.
4	1 s	Ch	4 min.
5	2 s	Dh	8 min.
6	4 s	Eh	16 min.
7	8 s	Fh	32 min.

The number of S units per M unit field gives the ratio of these MSF address values. For media conforming to the CD data and CD-DA standard, this value is 60.

The number of F units per S unit field gives the ratio of these MSF address values. For media conforming to the CD data and CD-DA standard, this value is 75.

E.3.3 MM Capabilities and Mechanical Status Page (Page Code 2Ah)

The MM Capabilities and Mechanical Status Page (Table E.20) is read only and should not be set with Mode Select.

Table E.20 – MM Capabilities and Mechanical Status Page

Byte	Bit	7	6	5	4	3	2	1	0
0		PS	Reserved	Page Code (2Ah)					
1		Page Length (28+4*(maximum number of n))							
2		Reserved		DVD-RAM Read	DVD-R Read	DVD-ROM Read	Method 2	CD-RW Read	CD-R Read
3		Reserved		DVD- RAM Write	DVD-R Write	Reserved	Test Write	CD-R/RW Write	CD-R Write
4		BUF	Multi Session	Mode 2 Form 2	Mode 2 Form 1	Digital Port (2)	Digital Port (1)	Composite	Audio Play
5		Read Bar Code	UPC	ISRC	C2 Pointers supported	R-W De-interleaved & corrected	R-W Supported	CD-DA Stream is Accurate	CD-DA Cmds Supported
6		Loading Mechanism Type			Reserved	Eject (Individual or Magazine)	Prevent Jumper	Lock State	Lock
7		Reserved		R-W in Lead-In	Side Change Capable	S/W Slot Selection (SSS)	Changer Supports Disc Present	Separate Channel Mute	Separate volume levels
8	(MSB)	Obsolete							
9	(LSB)								
10	(MSB)	Number of Volume Levels Supported							
11	(LSB)								
12	(MSB)	Buffer Size Supported							
13	(LSB)								
14	(MSB)	Obsolete							
15	(LSB)								
16		Reserved							
17		Reserved	Length		LSBF	RCK	BCKF	Reserved	
18 – 21		Obsolete							
22	(MSB)	Copy Management Revision Supported							
23	(LSB)								
24 – 26		Reserved							
27		Reserved						Rotation Control Selected	
28	(MSB)	Current Write Speed Selected							
29	(LSB)								
30	(MSB)	Number of Logical Unit Write Speed Performance Descriptor Tables (n)							
31	(LSB)								
32 – 35		Logical Unit Write Speed Performance Descriptor Block #1							
36 – 39		Logical Unit Write Speed Performance Descriptor Block #2							
:		:							
n*4+28 ~ n*4+31		Logical Unit Write Speed Performance Descriptor Block #n							
		Padding							

The Parameter Savable bit is defined in 7.1.4.1.

The Page Length field should be set to a maximum length that contains the maximum number of Logical Unit Write Speed Performance Descriptor Blocks. The Page Length is fixed for a Logical Unit, but may be different from one Logical Unit to another. If the Logical Unit Write Speed Performance Descriptor Block for mounted media is shorter than the maximum length of the Logical Unit Write Speed Performance Descriptor Block, then the rest of the field should be padded with zeros. If a Logical Unit does not support high speed CD-R/RW recording, the Logical Unit should not return mode page data after byte 26.

When DVD-RAM Read is set to one, the Logical Unit should support reading DVD-RAM media.

When DVD-R Read is set to one, the Logical Unit should support reading DVD-R media.

When DVD-ROM Read bit is set to one, the Logical Unit should support reading DVD-ROM media.

When Method 2 is set to one, the Logical Unit should support the reading fixed packet tracks on CD-R/RW media where the Addressing type is Method 2.

When CD-RW Read is set to one, the Logical Unit should support reading CD-RW media.

When CD-R Read is set to one, the Logical Unit should support the read function of CD-R disc.

When DVD-RAM Write is set to one, the Logical Unit should support writing DVD-RAM media.

When DVD-R Write is set to one, the Logical Unit should support writing DVD-R media.

When Test Write is set to one, the Logical Unit should support the Test Write function described in 7.4.

When CD-R/RW Write is set to one, the Logical Unit should support writing CD-R/RW media.

When CD-R Write is set to one, the Logical Unit should support the writing CD-R media.

When Audio Play is set to one, the Logical Unit should be capable of analog Audio Play.

When Composite is set to one, the Logical Unit should be capable of delivering a composite Audio and Video data stream from an independent digital port.

When Digital Port (1) is set to one, the Logical Unit should support digital output (IEC958) on port 1.

When Digital Port (2) is set to one, the Logical Unit should support digital output(IEC958) on port 2.

When Mode 2 Form 1 is set to one, the Logical Unit should support reading CD sectors in Mode 2 Form 1 format.

When Mode 2 Form 2 is set to one, the Logical Unit should support reading CD sectors in Mode 2 Form 2 format.

When Multi Session is set to one, the Logical Unit should support reading multiple session CD discs.

When BUF is set to one, the Logical Unit should support buffer under-run free recording on CD-R/RW media. For non-CD Logical Units, this bit is reserved.

When CD-DA Commands Supported is set to one, the Logical Unit should support reading CD Audio sectors via the READ CD command (see 6.24).

When CD-DA Stream is Accurate is set to one, the Logical Unit should support an audio location without losing place to continue the READ CD command. If 0, the Logical Unit is incapable of accurately restarting the CD-DA read operation. If the audio read stream is lost, the READ CD command should be terminated with CHECK CONDITION status and SK/ASC/ASCQ values should be set to ABORTED COMMAND/READ ERROR – LOSS OF STREAMING. Since the Logical Unit is unable to provide properly aligned data, the Initiator may choose to supply data realignment procedures. If 1, the Logical Unit is able to continue from a loss of streaming condition and no error should be generated.

When Sub-channels R-W Reading Supported is set to one, the Logical Unit should support reading R-W sub-channel via the READ CD command (see 6.24).

When R-W Sub-channels De-interleaved & Corrected is set to one, the Logical Unit should support reading R-W sub-channel via the READ CD command with the returned data de-interleaved and error corrected.

When C2 Pointers Supported is set to one, the Logical Unit should support reading C2 Error Pointers

and C2 Block Error flags via the READ CD command.

When ISRC is set to one, the Logical Unit should support reading International Standard Recording Code Information via the READ SUB-CHANNEL command.

When UPC is set to one, the Logical Unit should support reading Media Catalog Number (also known as Uniform Product Code) via the READ SUB-CHANNEL command.

When Read Bar Code is set to one, the Logical Unit should support reading the disc bar code and returning the information via the READ DISC INFORMATION command.

When Lock is set to one, the Logical Unit should support locking the media within the physical Logical Unit via the PREVENT ALLOW MEDIUM REMOVAL command.

When Lock is set to one and Lock State is set to zero, the Logical Unit is currently in the allow (unlocked) state. When Lock is set to one and Lock is set to one, the Logical Unit is currently in the prevent (locked) state. When Lock is set to zero, Lock State has no meaning.

When Prevent Jumper is set to zero, the Logical Unit has a physical jumper named the Prevent/Allow Jumper and the jumper is present. At power-on time, the default loading mechanism state should be allow (unlocked). Locking the Logical Unit with the PREVENT ALLOW MEDIUM REMOVAL command should not prevent the insertion of media.

When Prevent Jumper is set to one, the Logical Unit has a physical jumper named the Prevent/Allow Jumper and the jumper is not present. At power-on time, the default loading mechanism state should be prevent (locked). The Logical Unit should not accept new media or allow the ejection of media already loaded until an allow command is issued.

NOTE 37: The Prevent Jumper is optional. If the Logical Unit does not implement the prevent Jumper, then it should respond as if the jumper was present.

When Eject command is set to one, the Logical Unit should support media eject via the START STOP UNIT command with the LoEj bit set. If the mechanism is a Changer that uses a Magazine, then this bit indicates that the Magazine may be ejected.

Loading Mechanism Type (Byte 6, bits 7 – 5) should specify the type of disc loading the Logical Unit supports. The meanings of values in this field are shown in Table E.21 .

Table E.21 – Loading Mechanism Type

Byte 6, Bits			Loading Mechanism Type
7	6	5	
0	0	0	Caddy type loading mechanism
0	0	1	Tray type loading mechanism
0	1	0	Popup type loading mechanism
0	1	1	Reserved
1	0	0	Changer with individually changeable discs
1	0	1	Changer using a Magazine mechanism
1	1	0	Reserved
1	1	1	Reserved

When Separate Volume Levels is set to one, the Logical Unit should support separately controllable audio levels for each supported channel via the CD Audio Control Page (see 7.5).

When Separate Channel Mute is set to one, the Logical Unit should support independently muting each audio channel via the CD Audio Control Page (see 7.5).

When Supports Disc Present (SDP) is set to one, the Logical Unit contains an embedded changer, and after a reset condition or a magazine change, the Logical Unit is capable of reporting the exact contents of the slots. The response to the MECHANISM STATUS command should contain valid "Disc is Present" status information for all slots.

When Software Slot Selection (SSS) is set to one, this bit controls the behavior of the LOAD/UNLOAD MEDIUM command when trying to load a Slot with no Disc present.

When Side Change Capable is set to one, the Logical Unit is capable of selecting both sides of Discs. This capability is typically reported only for Logical Units that have changer functions.

When R through W in Lead-in is set to one, the Logical Unit is capable of reading the raw R-W Sub-channel information from the Lead-in.

In an earlier version of this standard, bytes 8 and 9 were assigned to Maximum Read Speed Supported (in kbps). This field has been obsolete.

The Number of Volume Levels Supported field is the number of discrete volume levels supported by the Logical Unit. If the Logical Unit only supports audio on and audio off, the Number of Volume Levels field should be set to 2.

The Buffer Size Supported field is the number of bytes of buffer dedicated to the data stream returned to the Initiator. This value is returned in Kbytes (Size/1 024). If the Logical Unit does not have a buffer cache, the value returned should be zero.

In an earlier version of this standard, bytes 14 and 15 were assigned to Current Read Speed Selected (in kbps). This field has been obsolete.

If both Digital Port (1) and Digital Port (2) are set to zero, then the content of byte 17 is unspecified. If either Digital Port (1) or Digital Port (2) is set to one, the Logical Unit should specify in Byte 17 the format of the Logical Unit's digital output as follows:

When BCKF is set to zero, data is valid on the rising edge of the BCK signal.

When BCKF is set to one, data is valid on the falling edge of the BCK signal.

When RCK is set to zero, HIGH on LRCK indicates right channel.

When RCK is set to one, HIGH on LRCK indicates left channel.

When LSBF is set to zero, most significant bit is first in data words.

When LSBF is set to one, least significant bit is first in data words.

Bits 5, 4 – Describes the bit length of IEC958 words (Table E.22).

Table E.22 – Bit Length of IEC958 Words

Bits 5, 4	Word Length
00	32
01	16
10	24
11	24 (I ² S)

In an earlier version of this standard, bytes 18 and 19 were assigned to Maximum Write Speed (in kbps). This field has been obsolete.

In an earlier version of this standard, bytes 20 and 21 were assigned to Current Write Speed Selected (in kbps). This field has been obsolete.

The Copy Management Revision Supported Field specifies the version of the DVD Content Protection scheme supported by the Logical Unit. For DVD this field should be set to 0001h, if either DVD CSS or CPPM is implemented. Otherwise, this field should be set this field to 0000h.

The Rotation Control Selected field specifies the current Rotation Control applied to the currently mounted disc as shown in Table E.24 .

The Current Write Speed Selected field indicates the data rate currently in use by the Logical Unit.

The Number of Logical Unit Write Speed Performance Descriptor Tables field specifies the number of Logical Unit Write Speed Performance Descriptor Blocks that follow this field.

Each Logical Unit Write Speed Performance Descriptor Block should contain rotation control information and write speed that is supported by the Logical Unit.

The Logical Unit Write Speed Performance Descriptor Block is structured as shown in Table E.23 .

Table E.23 – Logical Unit Write Speed Performance Descriptor Table Format

Byte	Bit	7	6	5	4	3	2	1	0	
0		Reserved								
1		Reserved					Rotation Control			
2	(MSB)	Write Speed Supported (bytes/sec)								
3		(LSB)								

Table E.24 – Rotation Control Selected field definition

Value	Definition
00b	CLV and Non-pure CAV
01b	Pure CAV
10b	Reserved
11b	Reserved

The Write Speed Supported field indicates the write speed that is supported by the Logical Unit. In the case of CAV recording, the returned value should indicate the speed at program area location of 79 min, 59 sec, 74 frames, regardless of actual capacity or disc diameter.

The Logical Unit should report a record speed in descending order. If the Logical Unit supports both CLV and CAV on the medium, then the Logical Unit should report all CLV descriptors first.

In the case of no recordable media mounted, the Logical Unit Write Speed Performance Descriptor Table should report the most appropriate list of the speed such as the list for CD-R disc or just maximum recording speed.

Annex F Error Reporting (Normative)

F.1 Overview

This annex lists error codes that may be generated by MMC defined Logical Units. Specific commands specify that certain errors occur in response to certain conditions, but each command does not contain a comprehensive list of possible error conditions.

F.2 Deferred Errors

Any error may be reported in response to any command due to the occurrence of a deferred error. e.g., a write error may occur due to a cached write command and that error should be reported in response to the next command.

F.3 Error Lists

A number of tables are included within this annex for error classification. Each table has columns identifying SK, ASC, and ASCQ values and the associated meaning. Each command description sub-clause contains an error-reporting table with entries that reference the tables included within this annex. The ASC and ASCQ values in this subclause duplicate information found in SPC-3. In the event there is a conflict between the ASC/ASCQ values in this standard and the ASC/ASCQ values in SPC-3, the values in this standard shall prevail.

There are 9 classifications:

Table F.1 lists Unit Attention conditions

Table F.2 lists errors that may occur during CDB or parameter list validation.

Table F.3 lists readiness errors.

Table F.4 lists protocol errors.

Table F.5 lists errors that may be generated due to general media access errors.

Table F.6 lists errors that may be generated by commands that access the media for reading.

Table F.7 lists errors that may be generated by commands that access the media for writing.

Table F.8 lists errors that may be generated by due to hardware failures.

Table F.9 lists errors associated with non-ATAPI environments.

Additionally, Table F.10 lists all errors.

Table F.1 – Unit Attention Conditions

Sense Key(s)	ASC	ASCQ	Description
6	28	00	NOT READY TO READY CHANGE, MEDIUM MAY HAVE CHANGED
6	28	01	IMPORT OR EXPORT ELEMENT ACCESSED
6	29	00	POWER ON, RESET, OR BUS DEVICE RESET OCCURRED
6	29	01	POWER ON OCCURRED
6	29	02	BUS RESET OCCURRED
6	29	03	BUS DEVICE RESET FUNCTION OCCURRED
6	29	04	DEVICE INTERNAL RESET
6	2A	00	PARAMETERS CHANGED
6	2A	01	MODE PARAMETERS CHANGED
6	2A	02	LOG PARAMETERS CHANGED
6	2E	00	INSUFFICIENT TIME FOR OPERATION
6	3B	0D	MEDIUM DESTINATION ELEMENT FULL
6	3B	0E	MEDIUM SOURCE ELEMENT EMPTY
6	3B	0F	END OF MEDIUM REACHED
6	3B	11	MEDIUM MAGAZINE NOT ACCESSIBLE
6	3B	12	MEDIUM MAGAZINE REMOVED
6	3B	13	MEDIUM MAGAZINE INSERTED
6	3B	14	MEDIUM MAGAZINE LOCKED
6	3B	15	MEDIUM MAGAZINE UNLOCKED
6	3F	00	TARGET OPERATING CONDITIONS HAVE CHANGED
6	3F	01	MICROCODE HAS BEEN CHANGED
6	3F	02	CHANGED OPERATING DEFINITION
6	3F	03	INQUIRY DATA HAS CHANGED
6	5A	00	OPERATOR REQUEST OR STATE CHANGE INPUT
6	5A	01	OPERATOR MEDIUM REMOVAL REQUEST
6	5A	02	OPERATOR SELECTED WRITE PROTECT
6	5A	03	OPERATOR SELECTED WRITE PERMIT
6	5B	00	LOG EXCEPTION
6	5B	01	THRESHOLD CONDITION MET
6	5B	02	LOG COUNTER AT MAXIMUM
6	5B	03	LOG LIST CODES EXHAUSTED
6	5E	00	LOW POWER CONDITION ON
6	5E	01	IDLE CONDITION ACTIVATED BY TIMER
6	5E	02	STANDBY CONDITION ACTIVATED BY TIMER
6	5E	03	IDLE CONDITION ACTIVATED BY COMMAND
6	5E	04	STANDBY CONDITION ACTIVATED BY COMMAND

Table F.2 – CDB or Parameter Validation Errors

Sense Key(s)	ASC	ASCQ	Description
5	1A	00	PARAMETER LIST LENGTH ERROR
5	20	00	INVALID COMMAND OPERATION CODE
5	21	00	LOGICAL BLOCK ADDRESS OUT OF RANGE
5	21	01	INVALID ELEMENT ADDRESS
5	21	02	INVALID ADDRESS FOR WRITE
5	24	00	INVALID FIELD IN CDB
5	26	00	INVALID FIELD IN PARAMETER LIST
5	26	01	PARAMETER NOT SUPPORTED
5	26	02	PARAMETER VALUE INVALID
5	26	03	THRESHOLD PARAMETERS NOT SUPPORTED

Table F.3 – Readiness Errors

Sense Key(s)	ASC	ASCQ	Description
2	04	00	LOGICAL UNIT NOT READY, CAUSE NOT REPORTABLE
2	04	01	LOGICAL UNIT IS IN PROCESS OF BECOMING READY
2	04	02	LOGICAL UNIT NOT READY, INITIALIZING CMD. REQUIRED
2	04	03	LOGICAL UNIT NOT READY, MANUAL INTERVENTION REQUIRED
2	04	04	LOGICAL UNIT NOT READY, FORMAT IN PROGRESS
2	04	07	LOGICAL UNIT NOT READY, OPERATION IN PROGRESS
2	04	08	LOGICAL UNIT NOT READY, LONG WRITE IN PROGRESS
2	30	00	INCOMPATIBLE MEDIUM INSTALLED
2	30	01	CANNOT READ MEDIUM – UNKNOWN FORMAT
2	30	02	CANNOT READ MEDIUM – INCOMPATIBLE FORMAT
2	30	03	CLEANING CARTRIDGE INSTALLED
2	30	04	CANNOT WRITE MEDIUM – UNKNOWN FORMAT
2	30	05	CANNOT WRITE MEDIUM – INCOMPATIBLE FORMAT
2	30	06	CANNOT FORMAT MEDIUM – INCOMPATIBLE MEDIUM
2	30	07	CLEANING FAILURE
2	30	11	CANNOT WRITE MEDIUM – UNSUPPORTED MEDIUM VERSION
2	3A	00	MEDIUM NOT PRESENT
2	3A	01	MEDIUM NOT PRESENT – TRAY CLOSED
2	3A	02	MEDIUM NOT PRESENT – TRAY OPEN
2	3E	00	LOGICAL UNIT HAS NOT SELF-CONFIGURED YET

Table F.4 – Protocol Errors

Sense Key(s)	ASC	ASCQ	Description
5	2C	00	COMMAND SEQUENCE ERROR
5	2C	03	CURRENT PROGRAM AREA IS NOT EMPTY
5	2C	04	CURRENT PROGRAM AREA IS EMPTY
5	30	08	CANNOT WRITE – APPLICATION CODE MISMATCH
5	30	09	CURRENT SESSION NOT FIXATED FOR APPEND
5	30	10	MEDIUM NOT FORMATTED
5	39	00	SAVING PARAMETERS NOT SUPPORTED
5	3D	00	INVALID BITS IN IDENTIFY MESSAGE
5	43	00	MESSAGE ERROR
5	53	02	MEDIUM REMOVAL PREVENTED
5	64	00	ILLEGAL MODE FOR THIS TRACK
5	64	01	INVALID PACKET SIZE
5	6F	00	COPY PROTECTION KEY EXCHANGE FAILURE – AUTHENTICATION FAILURE
5	6F	01	COPY PROTECTION KEY EXCHANGE FAILURE – KEY NOT PRESENT
5	6F	02	COPY PROTECTION KEY EXCHANGE FAILURE –KEY NOT ESTABLISHED
5	6F	03	READ OF SCRAMBLED SECTOR WITHOUT AUTHENTICATION
5	6F	04	MEDIA REGION CODE IS MISMATCHED TO LOGICAL UNIT REGION
5	6F	05	LOGICAL UNIT REGION MUST BE PERMANENT/REGION RESET COUNT ERROR
5	72	04	EMPTY OR PARTIALLY WRITTEN RESERVED TRACK
5	72	05	NO MORE TRACK RESERVATIONS ALLOWED

Table F.5 – General Media Access Errors

Sense Key(s)	ASC	ASCQ	Description
3	06	00	NO REFERENCE POSITION FOUND
4	09	00	TRACK FOLLOWING ERROR
4	09	01	TRACKING SERVO FAILURE
4	09	02	FOCUS SERVO FAILURE
4	09	03	SPINDLE SERVO FAILURE
3	15	00	RANDOM POSITIONING ERROR
3	15	01	MECHANICAL POSITIONING ERROR
5	30	00	INCOMPATIBLE MEDIUM INSTALLED
5	30	01	CANNOT READ MEDIUM – UNKNOWN FORMAT
5	30	02	CANNOT READ MEDIUM – INCOMPATIBLE FORMAT
5	30	03	CLEANING CARTRIDGE INSTALLED
5	30	04	CANNOT WRITE MEDIUM – UNKNOWN FORMAT
5	30	05	CANNOT WRITE MEDIUM – INCOMPATIBLE FORMAT
5	30	06	CANNOT FORMAT MEDIUM – INCOMPATIBLE MEDIUM
5	30	07	CLEANING FAILURE
5	30	08	CANNOT WRITE – APPLICATION CODE MISMATCH
5	30	09	CURRENT SESSION NOT FIXATED FOR APPEND
5	30	10	MEDIUM NOT FORMATTED
3	31	00	MEDIUM FORMAT CORRUPTED
3	31	01	FORMAT COMMAND FAILED
3	31	02	ZONED FORMATTING FAILED DUE TO SPARE LINKING
3	57	00	UNABLE TO RECOVER TABLE-OF-CONTENTS
3	73	00	CD CONTROL ERROR

Table F.6 – Errors Associated with Reading

Sense Key(s)	ASC	ASCQ	Description
3	11	00	UNRECOVERED READ ERROR
3	11	01	READ RETRIES EXHAUSTED
3	11	02	ERROR TOO LONG TO CORRECT
3	11	05	L-EC UNCORRECTABLE ERROR
3	11	06	CIRC UNRECOVERED ERROR
3	11	0F	ERROR READING UPC/EAN NUMBER
3	11	10	ERROR READING ISRC NUMBER
B	11	11	READ ERROR – LOSS OF STREAMING
3	15	00	RANDOM POSITIONING ERROR
3	15	01	MECHANICAL POSITIONING ERROR
3	15	02	POSITIONING ERROR DETECTED BY READ OF MEDIUM
1	17	00	RECOVERED DATA WITH NO ERROR CORRECTION APPLIED
1	17	01	RECOVERED DATA WITH RETRIES
1	17	02	RECOVERED DATA WITH POSITIVE HEAD OFFSET
1	17	03	RECOVERED DATA WITH NEGATIVE HEAD OFFSET
1	17	04	RECOVERED DATA WITH RETRIES AND/OR CIRC APPLIED
1	17	05	RECOVERED DATA USING PREVIOUS SECTOR ID
1	17	07	RECOVERED DATA WITHOUT ECC – RECOMMEND REASSIGNMENT
1	17	08	RECOVERED DATA WITHOUT ECC – RECOMMEND REWRITE
1	17	09	RECOVERED DATA WITHOUT ECC – DATA REWRITTEN
1	18	00	RECOVERED DATA WITH ERROR CORRECTION APPLIED
1	18	01	RECOVERED DATA WITH ERROR CORR. & RETRIES APPLIED
1	18	02	RECOVERED DATA – DATA AUTO-REALLOCATED
1	18	03	RECOVERED DATA WITH CIRC
1	18	04	RECOVERED DATA WITH L-EC
1	18	05	RECOVERED DATA – RECOMMEND REASSIGNMENT
1	18	06	RECOVERED DATA – RECOMMEND REWRITE
1	18	08	RECOVERED DATA WITH LINKING
8	--	--	BLANK CHECK

Table F.7 – Errors Associated with Writing

Sense Key(s)	ASC	ASCQ	Description
3	0C	00	WRITE ERROR
3	0C	07	WRITE ERROR – RECOVERY NEEDED
3	0C	08	WRITE ERROR – RECOVERY FAILED
3	0C	09	WRITE ERROR – LOSS OF STREAMING
3	0C	0A	WRITE ERROR – PADDING BLOCKS ADDED
7	27	00	WRITE PROTECTED
7	27	01	HARDWARE WRITE PROTECTED
7	27	02	LOGICAL UNIT SOFTWARE WRITE PROTECTED
7	27	03	ASSOCIATED WRITE PROTECT
7	27	04	PERSISTENT WRITE PROTECT
7	27	05	PERMANENT WRITE PROTECT
7	27	06	CONDITIONAL WRITE PROTECT
2	30	04	CANNOT WRITE MEDIUM – UNKNOWN FORMAT
2	30	05	CANNOT WRITE MEDIUM – INCOMPATIBLE FORMAT
2	30	06	CANNOT FORMAT MEDIUM – INCOMPATIBLE MEDIUM
2	30	07	CLEANING FAILURE
5	30	08	CANNOT WRITE – APPLICATION CODE MISMATCH
5	30	09	CURRENT SESSION NOT FIXATED FOR APPEND
5	30	10	MEDIUM NOT FORMATTED
2	30	11	CANNOT WRITE MEDIUM – UNSUPPORTED MEDIUM VERSION
3	31	00	MEDIUM FORMAT CORRUPTED
3	31	01	FORMAT COMMAND FAILED
3	31	02	ZONED FORMATTING FAILED DUE TO SPARE LINKING
3	51	00	ERASE FAILURE
3	51	01	ERASE FAILURE – INCOMPLETE ERASE OPERATION DETECTED
1	5D	03	FAILURE PREDICTION THRESHOLD EXCEEDED – Predicted Spare Area Exhaustion
1	5D	FF	FAILURE PREDICTION THRESHOLD EXCEEDED (FALSE)
3	72	00	SESSION FIXATION ERROR
3	72	01	SESSION FIXATION ERROR WRITING LEAD-IN
3	72	02	SESSION FIXATION ERROR WRITING LEAD-OUT
5	72	03	SESSION FIXATION ERROR – INCOMPLETE TRACK IN SESSION
5	72	04	EMPTY OR PARTIALLY WRITTEN RESERVED TRACK
5	72	05	NO MORE TRACK RESERVATIONS ALLOWED
1	73	01	POWER CALIBRATION AREA ALMOST FULL
3	73	02	POWER CALIBRATION AREA IS FULL
3	73	03	POWER CALIBRATION AREA ERROR
3	73	04	PROGRAM MEMORY AREA UPDATE FAILURE
3	73	05	PROGRAM MEMORY AREA IS FULL
1	73	06	RMA/PMA IS ALMOST FULL
8	--	--	BLANK CHECK

Table F.8 – Hardware Failures

Sense Key(s)	ASC	ASCQ	Description
4	00	17	CLEANING REQUESTED
4	05	00	LOGICAL UNIT DOES NOT RESPOND TO SELECTION
4	08	00	LOGICAL UNIT COMMUNICATION FAILURE
4	08	01	LOGICAL UNIT COMMUNICATION TIMEOUT
4	08	02	LOGICAL UNIT COMMUNICATION PARITY ERROR
4	08	03	LOGICAL UNIT COMMUNICATION CRC ERROR (ULTRA-DMA/32)
4	09	00	TRACK FOLLOWING ERROR
4	09	01	TRACKING SERVO FAILURE
4	09	02	FOCUS SERVO FAILURE
4	09	03	SPINDLE SERVO FAILURE
4	09	04	HEAD SELECT FAULT
4	15	00	RANDOM POSITIONING ERROR
4	15	01	MECHANICAL POSITIONING ERROR
4	1B	00	SYNCHRONOUS DATA TRANSFER ERROR
4	3B	16	MECHANICAL POSITIONING OR CHANGER ERROR
4	3E	01	LOGICAL UNIT FAILURE
4	3E	02	TIMEOUT ON LOGICAL UNIT
4	40	NN	DIAGNOSTIC FAILURE ON COMPONENT NN (80H-FFH)
4	44	00	INTERNAL TARGET FAILURE
4	46	00	UNSUCCESSFUL SOFT RESET
4	47	00	SCSI PARITY ERROR
4	4A	00	COMMAND PHASE ERROR
4	4B	00	DATA PHASE ERROR
4	4C	00	LOGICAL UNIT FAILED SELF-CONFIGURATION
4	53	00	MEDIA LOAD OR EJECT FAILED
1	5D	01	FAILURE PREDICTION THRESHOLD EXCEEDED – Predicted Media failure
1	5D	02	LOGICAL UNIT FAILURE PREDICTION THRESHOLD EXCEEDED
1	5D	03	FAILURE PREDICTION THRESHOLD EXCEEDED – Predicted Spare Area Exhaustion
1	5D	FF	FAILURE PREDICTION THRESHOLD EXCEEDED (FALSE)
4	65	00	VOLTAGE FAULT

Table F.9 – Errors Associated with non-ATAPI Environments

Sense Key(s)	ASC	ASCQ	Description
B	00	06	I/O PROCESS TERMINATED
5	07	00	MULTIPLE PERIPHERAL DEVICES SELECTED
4	08	03	LOGICAL UNIT COMMUNICATION CRC ERROR (ULTRA-DMA/32)
4	09	04	HEAD SELECT FAULT
1	0B	00	WARNING
1	0B	01	WARNING – SPECIFIED TEMPERATURE EXCEEDED
1	0B	02	WARNING – ENCLOSURE DEGRADED
4	1B	00	SYNCHRONOUS DATA TRANSFER ERROR
5	25	00	LOGICAL UNIT NOT SUPPORTED
6	2A	03	RESERVATIONS PREEMPTED
5	2B	00	COPY CANNOT EXECUTE SINCE INITIATOR CANNOT DISCONNECT
6	2F	00	COMMANDS CLEARED BY ANOTHER INITIATOR
	34	00	ENCLOSURE FAILURE
	35	00	ENCLOSURE SERVICES FAILURE
	35	01	UNSUPPORTED ENCLOSURE FUNCTION
	35	02	ENCLOSURE SERVICES UNAVAILABLE
	35	03	ENCLOSURE SERVICES TRANSFER FAILURE
	35	04	ENCLOSURE SERVICES TRANSFER REFUSED
5	3D	00	INVALID BITS IN IDENTIFY MESSAGE
5	43	00	MESSAGE ERROR
B	45	00	SELECT OR RESELECT FAILURE
4	47	00	SCSI PARITY ERROR
B	48	00	INITIATOR DETECTED ERROR MESSAGE RECEIVED
B	49	00	INVALID MESSAGE ERROR
4	4A	00	COMMAND PHASE ERROR
4	4B	00	DATA PHASE ERROR
B	4D	NN	TAGGED OVERLAPPED COMMANDS (NN = QUEUE TAG)

Table F.10 – Logical Unit Sense Key, ASC and ASCQ Assignments

Sense Key(s)	ASC	ASCQ	Description
0	00	00	NO ADDITIONAL SENSE INFORMATION
B	00	06	I/O PROCESS TERMINATED
0	00	11	AUDIO PLAY OPERATION IN PROGRESS
0	00	12	AUDIO PLAY OPERATION PAUSED
0	00	13	AUDIO PLAY OPERATION SUCCESSFULLY COMPLETED
0	00	14	AUDIO PLAY OPERATION STOPPED DUE TO ERROR
0	00	15	NO CURRENT AUDIO STATUS TO RETURN
4	00	17	CLEANING REQUESTED
3	02	00	NO SEEK COMPLETE
2	04	00	LOGICAL UNIT NOT READY, CAUSE NOT REPORTABLE
2	04	01	LOGICAL UNIT IS IN PROCESS OF BECOMING READY
2	04	02	LOGICAL UNIT NOT READY, INITIALIZING CMD. REQUIRED
2	04	03	LOGICAL UNIT NOT READY, MANUAL INTERVENTION REQUIRED
2	04	04	LOGICAL UNIT NOT READY, FORMAT IN PROGRESS
2	04	07	LOGICAL UNIT NOT READY, OPERATION IN PROGRESS
2	04	08	LOGICAL UNIT NOT READY, LONG WRITE IN PROGRESS
4	05	00	LOGICAL UNIT DOES NOT RESPOND TO SELECTION
3	06	00	NO REFERENCE POSITION FOUND
5	07	00	MULTIPLE PERIPHERAL DEVICES SELECTED
4	08	00	LOGICAL UNIT COMMUNICATION FAILURE
4	08	01	LOGICAL UNIT COMMUNICATION TIMEOUT
4	08	02	LOGICAL UNIT COMMUNICATION PARITY ERROR
4	08	03	LOGICAL UNIT COMMUNICATION CRC ERROR (ULTRA-DMA/32)
4	09	00	TRACK FOLLOWING ERROR
4	09	01	TRACKING SERVO FAILURE
4	09	02	FOCUS SERVO FAILURE
4	09	03	SPINDLE SERVO FAILURE
4	09	04	HEAD SELECT FAULT
6	0A	00	ERROR LOG OVERFLOW
1	0B	00	WARNING
1	0B	01	WARNING – SPECIFIED TEMPERATURE EXCEEDED
1	0B	02	WARNING – ENCLOSURE DEGRADED
3	0C	00	WRITE ERROR
3	0C	07	WRITE ERROR – RECOVERY NEEDED
3	0C	08	WRITE ERROR – RECOVERY FAILED
3	0C	09	WRITE ERROR – LOSS OF STREAMING
3	0C	0A	WRITE ERROR – PADDING BLOCKS ADDED

Table F.10 – Logical Unit Sense Key, ASC and ASCQ Assignments (continued)

Sense Key(s)	ASC	ASCQ	Description
3	11	00	UNRECOVERED READ ERROR
3	11	01	READ RETRIES EXHAUSTED
3	11	02	ERROR TOO LONG TO CORRECT
3	11	05	L-EC UNCORRECTABLE ERROR
3	11	06	CIRC UNRECOVERED ERROR
3	11	0F	ERROR READING UPC/EAN NUMBER
3	11	10	ERROR READING ISRC NUMBER
B	11	11	READ ERROR – LOSS OF STREAMING
3 or 4	15	00	RANDOM POSITIONING ERROR
3 or 4	15	01	MECHANICAL POSITIONING ERROR
3	15	02	POSITIONING ERROR DETECTED BY READ OF MEDIUM
1	17	00	RECOVERED DATA WITH NO ERROR CORRECTION APPLIED
1	17	01	RECOVERED DATA WITH RETRIES
1	17	02	RECOVERED DATA WITH POSITIVE HEAD OFFSET
1	17	03	RECOVERED DATA WITH NEGATIVE HEAD OFFSET
1	17	04	RECOVERED DATA WITH RETRIES AND/OR CIRC APPLIED
1	17	05	RECOVERED DATA USING PREVIOUS SECTOR ID
1	17	07	RECOVERED DATA WITHOUT ECC – RECOMMEND REASSIGNMENT
1	17	08	RECOVERED DATA WITHOUT ECC – RECOMMEND REWRITE
1	17	09	RECOVERED DATA WITHOUT ECC – DATA REWRITTEN
1	18	00	RECOVERED DATA WITH ERROR CORRECTION APPLIED
1	18	01	RECOVERED DATA WITH ERROR CORR. & RETRIES APPLIED
1	18	02	RECOVERED DATA – DATA AUTO-REALLOCATED
1	18	03	RECOVERED DATA WITH CIRC
1	18	04	RECOVERED DATA WITH L-EC
1	18	05	RECOVERED DATA – RECOMMEND REASSIGNMENT
1	18	06	RECOVERED DATA – RECOMMEND REWRITE
1	18	08	RECOVERED DATA WITH LINKING
5	1A	00	PARAMETER LIST LENGTH ERROR
4	1B	00	SYNCHRONOUS DATA TRANSFER ERROR
A	1D	00	MISCOMPARE DURING VERIFY OPERATION
5	20	00	INVALID COMMAND OPERATION CODE
5	21	00	LOGICAL BLOCK ADDRESS OUT OF RANGE
5	21	01	INVALID ELEMENT ADDRESS
5	21	02	INVALID ADDRESS FOR WRITE
5	24	00	INVALID FIELD IN CDB
5	25	00	LOGICAL UNIT NOT SUPPORTED

Table F.10 – Logical Unit Sense Key, ASC and ASCQ Assignments (continued)

Sense Key(s)	ASC	ASCQ	Description
5	26	00	INVALID FIELD IN PARAMETER LIST
5	26	01	PARAMETER NOT SUPPORTED
5	26	02	PARAMETER VALUE INVALID
5	26	03	THRESHOLD PARAMETERS NOT SUPPORTED
5	26	04	INVALID RELEASE OF ACTIVE PERSISTENT RESERVATION
7	27	00	WRITE PROTECTED
7	27	01	HARDWARE WRITE PROTECTED
7	27	02	LOGICAL UNIT SOFTWARE WRITE PROTECTED
7	27	03	ASSOCIATED WRITE PROTECT
7	27	04	PERSISTENT WRITE PROTECT
7	27	05	PERMANENT WRITE PROTECT
7	27	06	CONDITIONAL WRITE PROTECT
6	28	00	NOT READY TO READY CHANGE, MEDIUM MAY HAVE CHANGED
6	28	01	IMPORT OR EXPORT ELEMENT ACCESSED
6	29	00	POWER ON, RESET, OR BUS DEVICE RESET OCCURRED
6	29	01	POWER ON OCCURRED
6	29	02	SCSI BUS RESET OCCURRED
6	29	03	BUS DEVICE RESET FUNCTION OCCURRED
6	29	04	DEVICE INTERNAL RESET
6	2A	00	PARAMETERS CHANGED
6	2A	01	MODE PARAMETERS CHANGED
6	2A	02	LOG PARAMETERS CHANGED
6	2A	03	RESERVATIONS PREEMPTED
5	2B	00	COPY CANNOT EXECUTE SINCE INITIATOR CANNOT DISCONNECT
5	2C	00	COMMAND SEQUENCE ERROR
5	2C	03	CURRENT PROGRAM AREA IS NOT EMPTY
5	2C	04	CURRENT PROGRAM AREA IS EMPTY
6	2E	00	INSUFFICIENT TIME FOR OPERATION
6	2F	00	COMMANDS CLEARED BY ANOTHER INITIATOR
2	30	00	INCOMPATIBLE MEDIUM INSTALLED
2	30	01	CANNOT READ MEDIUM – UNKNOWN FORMAT
2	30	02	CANNOT READ MEDIUM – INCOMPATIBLE FORMAT
2	30	03	CLEANING CARTRIDGE INSTALLED
2	30	04	CANNOT WRITE MEDIUM – UNKNOWN FORMAT
2	30	05	CANNOT WRITE MEDIUM – INCOMPATIBLE FORMAT
2	30	06	CANNOT FORMAT MEDIUM – INCOMPATIBLE MEDIUM
2	30	07	CLEANING FAILURE
5	30	08	CANNOT WRITE – APPLICATION CODE MISMATCH
5	30	09	CURRENT SESSION NOT FIXATED FOR APPEND
5	30	10	MEDIUM NOT FORMATTED
2	30	11	CANNOT WRITE MEDIUM – UNSUPPORTED MEDIUM VERSION

Table F.10 – Logical Unit Sense Key, ASC and ASCQ Assignments (continued)

Sense Key(s)	ASC	ASCQ	Description
3	31	00	MEDIUM FORMAT CORRUPTED
3	31	01	FORMAT COMMAND FAILED
3	31	02	ZONED FORMATTING FAILED DUE TO SPARE LINKING
	34	00	ENCLOSURE FAILURE
	35	00	ENCLOSURE SERVICES FAILURE
	35	01	UNSUPPORTED ENCLOSURE FUNCTION
	35	02	ENCLOSURE SERVICES UNAVAILABLE
	35	03	ENCLOSURE SERVICES TRANSFER FAILURE
	35	04	ENCLOSURE SERVICES TRANSFER REFUSED
1	37	00	ROUNDED PARAMETER
5	39	00	SAVING PARAMETERS NOT SUPPORTED
2	3A	00	MEDIUM NOT PRESENT
2	3A	01	MEDIUM NOT PRESENT – TRAY CLOSED
2	3A	02	MEDIUM NOT PRESENT – TRAY OPEN
6	3B	0D	MEDIUM DESTINATION ELEMENT FULL
6	3B	0E	MEDIUM SOURCE ELEMENT EMPTY
6	3B	0F	END OF MEDIUM REACHED
6	3B	11	MEDIUM MAGAZINE NOT ACCESSIBLE
6	3B	12	MEDIUM MAGAZINE REMOVED
6	3B	13	MEDIUM MAGAZINE INSERTED
6	3B	14	MEDIUM MAGAZINE LOCKED
6	3B	15	MEDIUM MAGAZINE UNLOCKED
4	3B	16	MECHANICAL POSITIONING OR CHANGER ERROR
5	3D	00	INVALID BITS IN IDENTIFY MESSAGE
2	3E	00	LOGICAL UNIT HAS NOT SELF-CONFIGURED YET
4	3E	01	LOGICAL UNIT FAILURE
4	3E	02	TIMEOUT ON LOGICAL UNIT
6	3F	00	TARGET OPERATING CONDITIONS HAVE CHANGED
6	3F	01	MICROCODE HAS BEEN CHANGED
6	3F	02	CHANGED OPERATING DEFINITION
6	3F	03	INQUIRY DATA HAS CHANGED
4	40	NN	DIAGNOSTIC FAILURE ON COMPONENT NN (80H-FFH)
5	43	00	MESSAGE ERROR
4	44	00	INTERNAL TARGET FAILURE
B	45	00	SELECT OR RESELECT FAILURE
4	46	00	UNSUCCESSFUL SOFT RESET
4	47	00	SCSI PARITY ERROR
B	48	00	INITIATOR DETECTED ERROR MESSAGE RECEIVED
B	49	00	INVALID MESSAGE ERROR

Table F.10 – Logical Unit Sense Key, ASC and ASCQ Assignments (continued)

Sense Key(s)	ASC	ASCQ	Description
4	4A	00	COMMAND PHASE ERROR
4	4B	00	DATA PHASE ERROR
4	4C	00	LOGICAL UNIT FAILED SELF-CONFIGURATION
B	4D	NN	TAGGED OVERLAPPED COMMANDS (NN = QUEUE TAG)
B	4E	00	OVERLAPPED COMMANDS ATTEMPTED
3	51	00	ERASE FAILURE
3	51	01	ERASE FAILURE – INCOMPLETE ERASE OPERATION DETECTED
4	53	00	MEDIA LOAD OR EJECT FAILED
5	53	02	MEDIUM REMOVAL PREVENTED
5	55	00	SYSTEM RESOURCE FAILURE
3	57	00	UNABLE TO RECOVER TABLE-OF-CONTENTS
6	5A	00	OPERATOR REQUEST OR STATE CHANGE INPUT
6	5A	01	OPERATOR MEDIUM REMOVAL REQUEST
6	5A	02	OPERATOR SELECTED WRITE PROTECT
6	5A	03	OPERATOR SELECTED WRITE PERMIT
6	5B	00	LOG EXCEPTION
6	5B	01	THRESHOLD CONDITION MET
6	5B	02	LOG COUNTER AT MAXIMUM
6	5B	03	LOG LIST CODES EXHAUSTED
1	5D	01	FAILURE PREDICTION THRESHOLD EXCEEDED – Predicted Media failure
1	5D	02	LOGICAL UNIT FAILURE PREDICTION THRESHOLD EXCEEDED
1	5D	03	FAILURE PREDICTION THRESHOLD EXCEEDED – Predicted Spare Area Exhaustion
1	5D	FF	FAILURE PREDICTION THRESHOLD EXCEEDED (FALSE)
6	5E	00	LOW POWER CONDITION ON
6	5E	01	IDLE CONDITION ACTIVATED BY TIMER
6	5E	02	STANDBY CONDITION ACTIVATED BY TIMER
6	5E	03	IDLE CONDITION ACTIVATED BY COMMAND
6	5E	04	STANDBY CONDITION ACTIVATED BY COMMAND
5	63	00	END OF USER AREA ENCOUNTERED ON THIS TRACK
5	63	01	PACKET DOES NOT FIT IN AVAILABLE SPACE
5	64	00	ILLEGAL MODE FOR THIS TRACK
5	64	01	INVALID PACKET SIZE
4	65	00	VOLTAGE FAULT
5	6F	00	COPY PROTECTION KEY EXCHANGE FAILURE – AUTHENTICATION FAILURE
5	6F	01	COPY PROTECTION KEY EXCHANGE FAILURE – KEY NOT PRESENT
5	6F	02	COPY PROTECTION KEY EXCHANGE FAILURE –KEY NOT ESTABLISHED
5	6F	03	READ OF SCRAMBLED SECTOR WITHOUT AUTHENTICATION
5	6F	04	MEDIA REGION CODE IS MISMATCHED TO LOGICAL UNIT REGION
5	6F	05	LOGICAL UNIT REGION MUST BE PERMANENT/REGION RESET COUNT ERROR

Table F.10 – Logical Unit Sense Key, ASC and ASCQ Assignments (continued)

Sense Key(s)	ASC	ASCQ	Description
3	72	00	SESSION FIXATION ERROR
3	72	01	SESSION FIXATION ERROR WRITING LEAD-IN
3	72	02	SESSION FIXATION ERROR WRITING LEAD-OUT
5	72	03	SESSION FIXATION ERROR – INCOMPLETE TRACK IN SESSION
5	72	04	EMPTY OR PARTIALLY WRITTEN RESERVED TRACK
5	72	05	NO MORE TRACK RESERVATIONS ALLOWED
3	73	00	CD CONTROL ERROR
1	73	01	POWER CALIBRATION AREA ALMOST FULL
3	73	02	POWER CALIBRATION AREA IS FULL
3	73	03	POWER CALIBRATION AREA ERROR
3	73	04	PROGRAM MEMORY AREA UPDATE FAILURE
3	73	05	PROGRAM MEMORY AREA IS FULL
1	73	06	RMA/PMA IS ALMOST FULL
8	--	--	BLANK CHECK

NOTE 38: All table values are hexadecimal.

NOTE 39: All ASC values 80h through FFh are vendor specific.

NOTE 40: All ASCQ values 80h through FFh are vendor specific.

Annex G Features and Profiles (Informative)

G.1 What Is a Feature?

A Feature is an atomic unit of functionality.

The descriptions of Features in this document appear complex, however, these descriptions describe almost nothing new; they are simply the descriptions of existing legacy behavior. The only new parts are the descriptors themselves that are either static identification blocks or groups of information that the Logical Unit already has to operate, even in a legacy behavior. e.g., a Logical Unit internally identifies whether or not a PLAY AUDIO command may succeed; Features are simply a way to let the Initiator in on the secret.

Previously, new devices had to make a choice: to look completely like an old device with added functionality or as a new device not compatible with old drivers. Feature and Profiles, an Initiator may first determine if the "right" driver is available by examining the Profiles. If "the" right driver isn't available, the Initiator may identify operable subsets when multiple Profiles are reported. Finally, the Initiator may identify basic functions to use the device via the Feature reporting

G.2 History

The separation of status and error reporting is very important in multitasking environments. Typically, the operating system needs to constantly be aware of the status of the Logical Unit. Various applications, operating through a variety of OS interfaces, may also need to be aware of Logical Unit status. Reporting of status via errors breaks down in this environment; only one process is made aware of state changes via the error, while other processes may be unable to obtain the same state information because the error (status change) has already been reported to the Initiator (according to the Logical Unit).

Features do not replace legacy behavior. Features, in most cases, define a subset of legacy behavior. Several Features, taken together, are generally equivalent to legacy devices of the same type. Error and status reporting in legacy Initiator environments is the same as legacy devices, without any special mode setting.

The Features described in Mt. Fuji 2 add something new: reporting. Legacy devices, while implementing the content of the Features, did not have any mechanism to report specifically the Logical Unit's capabilities. The closest mechanism that has existed is a command that reported implemented commands. Implemented mode pages are also reportable via standard mechanisms. However, a command is more than an operation code (OpCode). A set of commands, mode pages, and behavior should be grouped together to be useful. e.g., write once MO, hard disk drives, and CD-R all use the WRITE command, but it is impossible to use the same strategies for writing these three media. Typically, different drivers or fragments of drivers are used for each kind of media. The previous mechanism only specifies that the WRITE command is implemented, but is unable to identify how to use it.

The capabilities of a particular Logical Unit may change at arbitrary times. The most common example of this is seen in a removable medium device. Even a basic removable magnetic medium device changes: from a random read/write device to a virtually less functional device when the medium is removed. Multi-function devices may change their behavior even more radically when they accept a variety of physical and logical formats.

Before Features, Initiators had to use a trial and error method for determining what may or may not function. Medium codes became outdated even before publication of the relevant standard, and still were not adequate to describe all media. The Profiles, also introduced in Mt. Fuji 2, provide an equivalent to the medium type. However, the Profile does not indicate exact capabilities for the Logical Unit/medium system, only a generic identification of core capabilities.

Feature reporting is not completely new. Operating systems first identify a driver via the device type. The device type implied a core set of functions, e.g. a CD-ROM Logical Unit should support READ, READ TOC, etc. However, even these commands do not function if no medium were loaded. A driver is able to determine media status by trying a few commands and examining the error codes. After

determining that media was present, a driver may be required to probe to find out about additional Features such as audio or medium changers. Features were “reportable,” but each Feature had a different mechanism, and many of the mechanisms relied on the success or failure of special “key” commands.

G.3 Implementation of Features

There are only two requirements to fully implement Features. The first is the GET CONFIGURATION command. This command is a very basic reporting command that reports some very static information; only a few Features have any dynamic fields; most Features have only one bit that changes. The command is a form of Inquiry: a technique for the Initiator to identify the device on the bus. The GET CONFIGURATION command simply provides more detail, and the information reported is expected to be dynamic.

Implementation of Feature reporting via the GET CONFIGURATION command is simple: the image of the result data may be copied from device ROM to its buffer, a few fields set with information already known to the Logical Unit (such as the block size), and a few bits set according to already existing flags in the firmware (i.e., DVD vs. CD, audio tracks present, etc.). Devices with non-removable media may have a completely static image that is reported. If a starting point other than the beginning is requested, the Logical Unit walks the table to find the first requested Feature, subtracts the offset from the data length, and transfers data starting at the same offset.

The second part of Features is reporting when the Features change. It is important for the Initiator to know the set of operations function with the Logical Unit at any given moment. Preemptive reporting of Feature changes greatly eases Initiator implementations by reducing the number of error conditions that need to be handled. The GET EVENT/STATUS NOTIFICATION command is used for status change reporting (an “Event.”) In many Logical Units, implementation simply requires recording an event whenever a UNIT ATTENTION is generated.

As mentioned earlier, Features are not new; their reporting is. This reporting has become very important in modern environments. Multiple drivers are talking to the same device, doing different tasks. e.g., a DVD-ROM Logical Unit may use the basic CD-ROM driver when a CD is installed, and another driver when a DVD is installed, and both a basic DVD driver and a separate copy protection process when copy protected media is mounted. All of these processes interact well to provide seamless and solid support. Feature reporting provides a method for clean interaction.

G.4 Compatibility

Logical Units implementing Feature reporting are fully compatible with legacy systems.

The GET CONFIGURATION changes no behavior of the Logical Unit; it simply reports existing state information. Repeated GET CONFIGURATION commands reports the same information (unless the user inserts or removes the medium, etc.). GET CONFIGURATION never changes any state information in the Logical Unit, including unit attention conditions.

The GET EVENT/STATUS NOTIFICATION command does not return CHECK CONDITION status to report a unit attention condition. Any pending unit attention condition for which a corresponding event is reported is not be cleared for the Logical Unit.

G.5 Summary

Features do not radically modify any legacy behavior or functionality. The only new parts involve reporting of behavior, and typically reflect state information already required of any firmware implementation, via two new commands. One command reports status, and the other notifies the Initiator that the status may have changed.

The benefits include easier coding of highly robust drivers, fewer error conditions, and forward and backward compatibility with operating system drivers.

**This page is intentionally
blank.**

Annex H Event Reporting Using GESN (Informative)

H.1 Introduction

The GET EVENT STATUS NOTIFICATION command applies to all MM devices.

The proper implementation of this command, together with operating system support, may result in improved autorun time, better user interface results, better time estimates for long operations, and many other user benefits.

H.2 Functional Behavior Guidelines

Requests for a Notification Class of zero should return an event header with the NEA bit set, the Notification Class field set to 000b, and the Supported Event Classes byte set to reflect all N supported Event Classes.

Requests may arrive at the device from an Initiator requesting any subset of events that the device supports. e.g., if { OpChange, DeviceBusy, Media } events are supported, then any of the following events may be requested by the Initiator by a single command block:

```

{ OpChange },
{ Media },
{ OpChange, Media },
{ OpChange, DeviceBusy, Media },
{ DeviceBusy },
{ OpChange, DeviceBusy },
{ DeviceBusy, Media }
```

The data reported by the Logical Unit to the Initiator should contain exactly one Event Class.

The data reported by the Logical Unit to the Initiator should contain an Event Class that was requested by the Initiator in the command block.

The data reported by the Logical Unit to the Initiator should not report a higher priority Event Class if the Event Class was not requested by the Initiator. If multiple Event Classes are requested by the Initiator in a single command block, the Logical Unit should follow the following procedure to determine the Event Class to report to the Initiator. For each requested Event Class, in order of priority per the specification:

- If an event other than a NoChange event exists, report it.
- If only NoChange events exist, report highest priority NoChange event.

The Logical Unit should simultaneously support (or queue) at least one event of each Event Class it supports. This prevents events of different Event Classes from interfering with each other.

e.g., if a Media Event and External Request event both occur at the same time, and the Initiator is continuously requesting both event types, then the Logical Unit should:

- Store both events.
- Report the External Request event first (higher priority).
- Clear the External Request event.
- Not clear the Media Event upon reporting the External Request event.
- Report the Media Event upon the next GET EVENT STATUS NOTIFICATION request.

To support such behavior early, the following high-level design to support GET EVENT STATUS NOTIFICATION should be considered. This does not preclude other implementations if the device behaves as expected by the operating system.

- For each supported Event Class, have a queue of appropriate depth (typically 1) of events for that Event Class. For Logical Units that support the Mt. Rainier format, the minimum

appropriate queue depth is 2, and special handling should be given to both the BGFormatCompleted and BGFormatRestarted Media Events.

- To implement this more simply, and to avoid queue depths greater than one, logically use a queue depth of 1 for the Media Events unless one of the BGFormat events is supported. When an event is generated by the device, the device looks to see if the new event is of greater priority than the current event that is stored of that class. If it is, the new event replaces the existing event in the 1-deep queue for that Event Class. Otherwise, the new event is discarded.

Annex I Power Management (Informative)

I.1 Power Management States

Four power states are defined. These are named Active, Idle, Standby, and Sleep with Active being the “Full-On” state, Sleep the “Off” state and “Idle, Standby and Sleep” progressively more aggressive power managed states. This model differs significantly from previous ATA and SCSI power management definitions. This new model (Table I.1) defines power states in terms of the perceived impact on the end user, instead of absolute power levels. The Idle state is optimized for minimal end user performance impact. The Standby state is optimized for power savings.

To provide consistent behavior across Logical Units, standard definitions are used for the power states of Logical Units. These states are defined in terms of the following criteria.

- Power Consumption: How much power the Logical Unit uses.
- Logical Unit Context: How much of the internal state of the Logical Unit is retained by hardware and what is to be restored by the responsible software.
- Restore time: How long it takes to raise the power level to the active power state and to put the Logical Unit into operational condition (including mechanical operation such as spin up) required before entering into the Active power state. Restoring is vendor specific and any mechanism may be employed here to raise the power consumption and to put the Logical Unit in operation condition required in a higher power state. e.g., “turning on or raising internal Vcc for power hungry circuits such as motors, laser sensors,” “raising internal Vcc or the clock frequency for the digital circuits,” etc. A critical factor is how quickly restoring the Logical Unit to operation condition required in a higher power state (e.g. spin up).
- De-power time: How long it takes to reduce the power to the desired level in lower power state after entering the lower power state from higher power state. De-powering is vendor specific and any mechanism may be employed here to reduce the power consumption. e.g., “turning off or lowering internal Vcc for power hungry circuits such as motors, laser sensors,” “lowering internal Vcc or reducing the clock frequency for the digital circuits,” “dynamic clock gating,” “cutting off the DC paths for unused circuits,” “turning off PLLs,” etc.

Table I.1 – Power Management Model States

Logical Unit State	Power Consumption	Logical Unit Context Retained	Restore Time
Active	As needed for operation	All	None
Idle	Less than Active	All	The Logical Unit should be restored to active state within 1 second on any request to enter active state, independent of the de-powering process.
Standby	Less than idle	All buffers are empty before entering Standby state.	Vendor specific: Greater than or equal to Idle to Active
Sleep	Less than Standby	None, Buffer & All of command queues are empty before entering Sleep state.	Greater than or equal to Standby to Active. Vendor Specific. May Need full initialization. The Initiator may remove Vcc.

Transitions between these power states may occur at the request of the Initiator or the Logical Unit. Transitions to a higher power state from a lower power state should occur after restoring the Logical Unit to the operating conditions (including mechanical operation if applicable, such as spin up) required in the higher power state. When the Logical Unit transitions from a higher power state to a lower power state, the Logical Unit should be considered to be in the lower power state when the Logical Unit is assured of reaching the lower power condition. Actual de-powering occurs after the Logical Unit enters the lower power state. The Logical Unit should generate a power event when the

Logical Unit is considered to have entered a power state.

In order to create a robust power management environment, Logical Units should support the following:

- Four power states: Active, Idle, Standby, and Sleep.
- Idle Timer. Provides a method for the Logical Unit to enter Idle state from Active state, following a programmed period of inactivity.
- Standby Timer. Provides a method for the Logical Unit to enter Standby state from either Active or Idle state, following a programmed period of inactivity.
- START STOP UNIT command and the Power Condition Field. Provides a method for the Initiator to request the Logical Unit to enter a power state.
- GET EVENT STATUS NOTIFICATION command. Notifies the Initiator of power state changes and current power status.
- Power Condition mode page. Enables or disables timers and specifies the reload value of the Idle and Standby timers.

I.2 Power State Transitions

Active State:

The Logical Unit is completely active and responsive. The Logical Unit is consuming its highest level of power. During the execution of a media access command (commands that reload both timers) the Logical Unit should be in active state.

The Logical Unit should minimize power consumption at all times, even when in the active state. Any mechanism may be employed, as long as it is transparent to software and does not prevent the Logical Unit from performing expected functions.

e.g., the Logical Unit may dynamically gate on/off internal clocks by monitoring bus activities and internal activities.

Idle State:

In Idle state, the Logical Unit is capable of responding to commands but may take up to one second longer to complete commands than the Active state. The Logical Unit is consuming less power than the Active state. Any mechanism may be employed as long as the restoring time is less than one second. The Logical Unit may, e.g.:

- Reduce internal clock frequency
- Lower the internal Vcc for digital circuits
- Dynamically gate internal clocks by monitoring bus/internal activities

Standby State:

In Standby state the Logical Unit should only be required to accept commands from the Initiator. All other mechanisms are in the power save condition. In Standby state, the Logical Unit is capable of responding to commands but the Logical Unit takes longer to complete commands than when in Idle state. Buffers should be emptied before entering into Standby state. The Logical Unit context should be preserved. The Logical Unit is consuming less power than when in Idle state.

Sleep State:

Maximum power saving state. Buffers and all command queues, including GET EVENT STATUS NOTIFICATION commands, should be emptied before entering into the Sleep state. When the Logical Unit enters the sleep state, any GET EVENT STATUS NOTIFICATION commands present in the command queue, should be removed from the command queue, without command completion. In this Sleep state, all functions are stopped and no commands, except for reset may be received. The unit is consuming less power than when in the Standby state. The Logical Unit context is invalid in the Sleep state.

The Initiator software should fully initialize the Logical Unit after exiting Sleep state, as all context may be lost in the Sleep state. Most devices provide a manual eject mechanism for removing/inserting a

disc independent of any lock/unlock mechanism employed. Given this possibility, when the Logical Unit is unable to determine if media has been changed while the Logical Unit was in the sleep state, the Logical Unit should report NEW MEDIA on the next GET EVENT STATUS NOTIFICATION (Media Status) command.

In the Sleep state, the Initiator may completely remove power from the device by turning off Vcc.

I.3 Power Management State Diagram

The state diagram, Figure I.1 defines state transitions for the power management model.

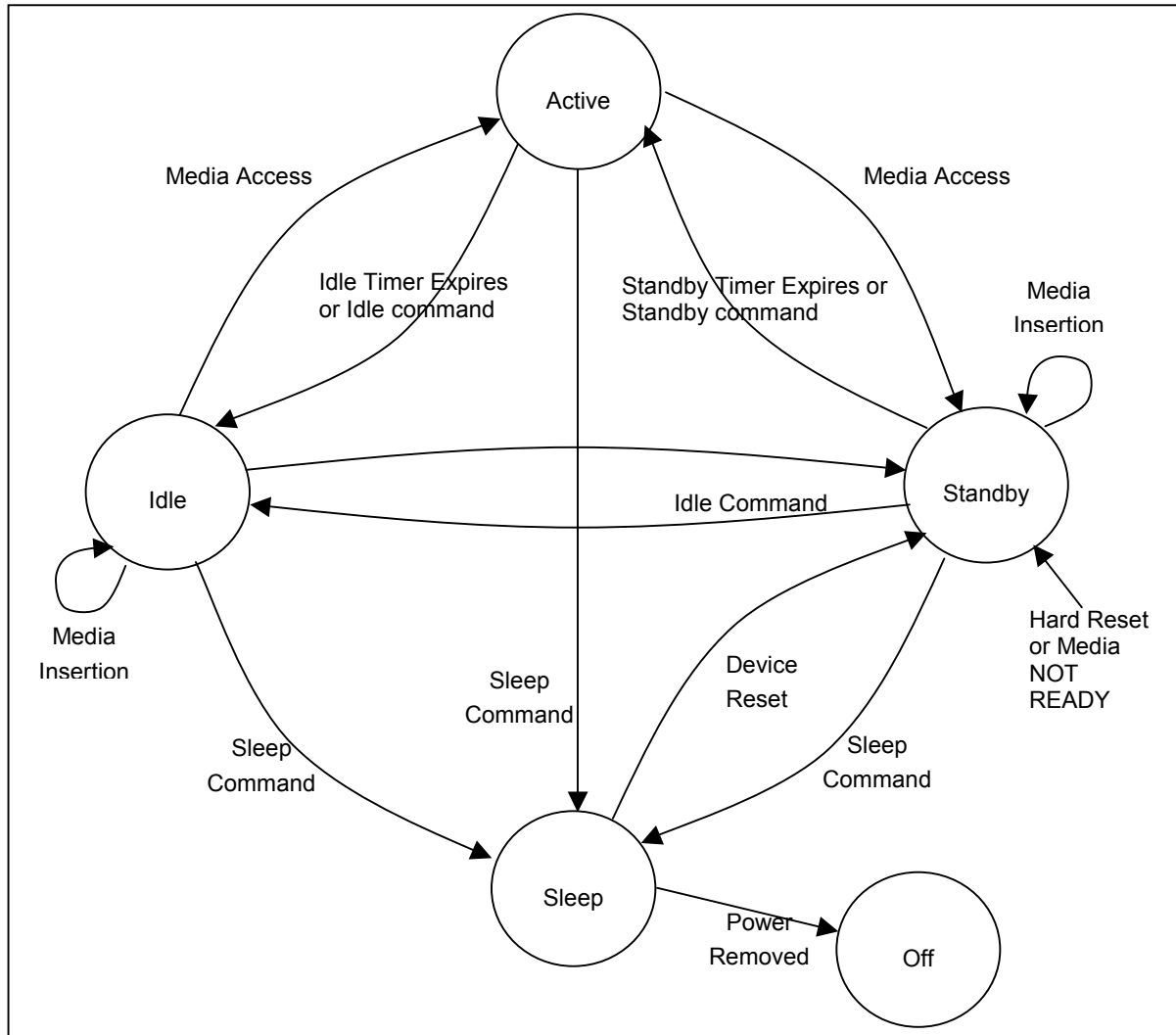

Figure I.1 – Power Management STATE Diagram

A power-on or hard reset always returns the Power State to the Standby State. A Device Reset does not alter the current Power State, unless the current Power State is Sleep. A Device Reset received while in sleep state returns the Power State to Standby.

The Sleep state is entered when the Logical Unit has been commanded to go to Sleep but Vcc is still applied to the device. Removing Vcc always takes the device to the Power Off State. Removing Vcc is recommended only when all Logical Units on a given bus are in Sleep State.

Table I.2 shows transition conditions for this model, and shows the Initial state, the Resultant state, Notification class, and Event class (Media or Power Management). Notification class and Event class

(Power Event/Media Event) fields specify the events that should be generated during the transitions as outlined in the GET EVENT STATUS NOTIFICATION command.

In Idle or Standby states, the Logical Unit should attempt to maintain the minimal power level for that state at all times. However, the Logical Unit may create transitory, higher power level conditions as needed. The transitory power conditions should not affect the reported power state, or generate power state events. Example transitory conditions are: flushing the buffers, emptying command queues, media insertion spin up, or auto off-line, etc. On insertion of new media, the Logical Unit may enter a transitory, higher power condition and stay in this condition for vendor specific time period. If the Logical Unit has not received a media access command (commands that reload both timers) during this period, the Logical Unit should return to the normal power level for the current power state. This prevents excessive power consumption while the Initiator is off-line.

It is permissible to enter intermediate states while in transition between states, however, the Logical Unit should not report power change events for the intermediate states. If the Logical Unit fails to enter the target Power State, the Logical Unit should return to the original Power State. Simultaneous expiration of multiple timers, should cause the Logical Unit to enter the lower Power State, and should only report the result of the transition to that state.

When the Logical Unit is reporting NOT READY, the Logical Unit should enter the Standby State.

If a power change event has not been reported to the Initiator, when a new event is generated, the Logical Unit may choose only to report the most recent power event.

I.4 Power Management Timers

The Idle and Standby timers provide a method for the Logical Unit to enter lower power states after an Initiator programmable period of inactivity, without direct Initiator command.

A timer is deactivated (no longer used by the Logical Unit, regardless of Enable / Disable setting provided from the Initiator) when the Logical Unit is in the associated power state or a lower power state.

A timer is both reactivated (the Logical Unit should use the timer if enabled) and reloaded when a Logical Unit transitions to power state higher than the associated timer.

Timers should be reloaded using the current timer value from the Power Condition mode page

Timers should be disabled/enabled as specified in the Power Condition mode page.

Timers should be set to the default condition upon receiving a power-on, or hard reset. The default condition for the Timers should be enabled with the values of the timers vendor specific.

I.5 Standby Timer

If the Standby Timer expires the Logical Unit should attempt to flush all buffers.

If this operation fails, the Logical Unit should remain in the current power state, and the Standby timer is reloaded. If the flush succeeds, the Logical Unit should enter the Standby State.

Table I.2 – State Transition Events and Status

Initial State	Resultant State	Cause of Transition	Notification Class	Event
Active	Active	Unsuccessful Idle, Standby, or Sleep command	Power	PwrChg-Fail
	Idle	Successful completion of Idle command	Power	PwrChg-Succ
	Idle	The expiration of Idle timer	Power	PwrChg-Succ
	Standby	Successful completion of Standby command	Power	PwrChg-Succ
	Standby	The expiration of Standby timer, all Buffers are empty	Power	PwrChg-Succ
	Sleep	Successful completion of Sleep command	Power	PwrChg-Succ
Idle	Idle	Successful completion of Idle command	Power	PwrChg-Succ
	Idle	Unsuccessful Idle, Standby, or Sleep command	Power	PwrChg-Fail
	Idle	Insertion of media and ready to use	Media	New Media
	Standby	The expiration of Standby timer, all buffers are empty	Power	PwrChg-Succ
	Standby	Successful completion of Standby command	Power	PwrChg-Succ
	Sleep	Successful completion of Sleep command	Power	PwrChg-Succ
	Active	Receptions of a command that reloads both timers	Power	PwrChg-Succ
Standby	Standby	Successful completion of Standby command	Power	PwrChg-Succ
	Standby	Unsuccessful Idle, Standby, or Sleep command	Power	PwrChg-Fail
	Standby	Insertion of media and ready to use	Media	NewMedia
	Idle	Successful completion of Idle command	Power	PwrChg-Succ
	Sleep	Successful completion of Sleep command	Power	PwrChg-Succ
	Active	Receptions of a command that reloads both timers	Power	PwrChg-Succ
Any	Standby	A power-on, or hard reset occurred, or the Logical Unit becomes NOT READY	Power	PwrChg-Succ
Sleep	Standby	Device Reset	Power	PwrChg-Succ

Commands issued by the Initiator should have an effect on the timers implemented by the Logical Unit. The effect is defined in Table I.3 .

Table I.3 – Effects of Initiator Commands on Timers

Initiator Command Issued	Timer Effects	Comments
BLANK	Reload Both	Recordable only
CHANGE DEFINITION	None	
CLOSE TRACK	Reload Both	Recordable only
COMPARE	Reload Both	SCSI only
EXCUTE LOGICAL UNIT DIAGNOSTIC	Reload Both	ATA command
SYNCHRONIZE CACHE	Reload Both	
FORMAT UNIT	Reload Both	Recordable only
GET CONFIGURATION	None	
GET EVENT STATUS NOTIFICATION	None	
INQUIRY	None	
LOAD/UNLOAD MEDIUM	Reload Both	
LOCK/UNLOCK CACHE	None	SCSI only. A Lock Cache command should prevent the Logical Unit from entering Standby or Sleep states.
LOG SELECT/SENSE	None	SCSI only
MECHANISM STATUS	None	
MODE SELECT	May Reload Timers	A MODE SELECT command that changes the Standby or Idle timers should reload the timer.
MODE SENSE	None	
PLAY AUDIO MSF	Reload Both	
PREFETCH	Reload Both	SCSI only
PREVENT ALLOW MEDIUM REMOVAL	Reload Standby	
READ (12)	Reload Both	
READ BUFFER	Reload Standby	
READ MM CAPACITY	Reload Both	
READ CD	Reload Both	
READ CD MSF	Reload Both	
READ DISC INFORMATION	Reload Both	
READ DVD STRUCTURE	Reload Both	
READ FORMATTABLE CAPACITIES	Reload Standby	
READ LONG	Reload Both	SCSI only
READ TRACK INFORMATION	Reload Both	
READ SUB-CHANNEL	Reload Both	
READ TOC/PMA/ATIP	Reload Both	

Table I.4 – Effects of Initiator Commands on Timers (cont.)

Initiator Command Issued	Timer Effects	Comments
RELEASE	None	SCSI only
REPAIR TRACK	Reload Both	Sequential MM Recordable
REPORT KEY	Reload Both	
GET PERFORMANCE	Reload Both	May need to access media
REQUEST SENSE	None	
RESERVE	None	SCSI only
RESERVE TRACK	Reload Both	Recordable only
REZERO	Reload Both	SCSI only
SCAN	Reload Both	
SEEK	Reload Both	
SEND EVENT	Reload Both	May effect media access
SEND KEY	Reload Both	
SEND DVD STRUCTURE	Reload Both	DVD Recordable
SEND OPC INFORMATION	Reload Both	Recordable only
SET CD SPEED	Reload Both	Obsolete
SET READ AHEAD	Reload Both	
SET STREAMING	Reload Both	
START STOP UNIT	See Start Stop Unit command	
TEST UNIT READY	Reload Both	
VERIFY	Reload Both	
WRITE	Reload Both	Recordable only
WRITE AND VERIFY (10)	Reload Both	Recordable only
Device Reset	Reload Both	Reset operation, the Logical Unit should not return to default timer conditions.
Other commands	Vendor Specific	

I.6 Power Management Status Reporting

The POWER STATUS field of the GET EVENT STATUS NOTIFICATION (Power Management Class) event data should always report the current Logical Unit power state. This provides a mechanism for the Initiator to query the current Power State, irrespective of state transitions.

**This page is intentionally
blank.**

Annex J The MRW Format (Informative)

J.1 The CD-MRW Format

J.1.1 Overview

A general description of the CD-MRW format is found in 4.5.

From the perspective of the original version of Orange Book, part III (CD-RW), the entire capacity of a CD-MRW disc consists of a single session containing a single track of 32 sector fixed packets (see Figure J.1).

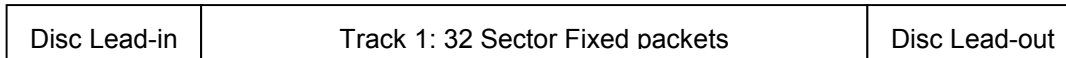

Figure J.1 - Track/Session Structure of a MRW Disc

CD-MRW contains additional structure.

J.1.2 CD-MRW Structure

The CD-MRW disc does have this format, but the *CD-MRW Defect Management & Physical Formatting* requires additional features, built upon the basic format (Figure J.2).

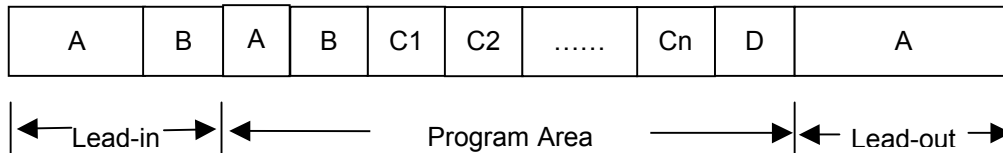

Figure J.2 - The Additional Structure

Lead-in, Part A	TOC, no change
Lead-in, Part B	TOC (in sub-channel Q) along with MTA (information is stored in main channel). The major change: Prior to CD-MRW, the lead-in has always been recorded track-at-once. With this new format, it is recorded as fixed packets. The MTA use begins with the packet that precedes the pre-gap. When needed, the MTA grows backward toward the disc center with a maximum size of 32 packets.
Program Area, Part A	Track 1 pre-gap has a fixed size of 150 sectors. The TDB identifies the track as fixed packet of length 32.
Program Area, Part B	The General Application Area (GAA) is a segment of the track that is not covered by the defect management system. This is fixed at 32 packets - 1 024 logical sectors - 2 MB.
Program Area, Parts Cx	The Defect Managed Area (DMA) consists of DMA segments, Cx. Each Cx consists of a spare area (SA) followed by a data area (DA). Each SA should contain 8 packets. Each DA within C1, C2, ..., Cn-1, should contain 136 packets for primary data. Cn may contain less than 136 packets, based upon disc capacity. The DMA is the logical concatenation of all DAs.
Program Area, Part D	STA: 33 packets reserved for secondary copies of the MTA structures.
Lead-out, Part A	Lead-out, no change

The number of Cx is determined as follows: P = number of 32 sector fixed packets available in the formatted track 1. The number of packets in all Cx is Pt = P – GAA size – STA size = P – 65. When Pt is divided by 144 (= 8 + 136), there is a quotient Q and remainder R.

If R ≤ 8, then Q = n. The DA size for each Cx is 136, and the lead-out begins R packets sooner.

If $R > 8$, then $Q = n - 1$. The DA for C_1, C_2, \dots, C_{n-1} is 136, the DA for C_n is $R - 8$ packets in length, and the lead-out is not offset into the program area.

The Initiator's primary address space is the DMA. By default, an LBA is presumed to refer to this address space. LBAs for the DMA do not match LBAs for a similarly formatted non-MRW disc. The spare block size is 2 048 bytes - one CD user sector from a size 32 fixed packet.

The GAA is available for compatibility with older systems. The GAA LBA space is 0, 1, 2, 3, ..., 1 023d. LBAs for the GAA exactly match LBAs for a similarly formatted pre-MRW disc.

J.1.3 CD-MRW Addressing

Since MRW has two LBA spaces, CD-MRW has two logical addressing schemes. The GAA contains 1 024 sectors, uses method 2 addressing, and exactly matches sector addressing as defined for traditional CD. See Table J.1.

Table J.1 - GAA Addressing on CD-MRW

Non-MRW LBA	MRW LBA in GAA
0	0
1	1
2	2
.	.
.	.
1 023	1023
1 024	Out of Range
1 025	Out of Range
....

When method 2 addressing is used, the primary LBA of the first sector of the DMA is at the non-MRW LBA of $(32 + 8) * 32 = 1280d$. Table J.2 shows the most inequities with non-MRW LBA.

Table J.2 - DMA Addressing on CD-MRW

Non-MRW LBA	MRW LBA (primary)
1 280	DMA 0
1 281	DMA 1
1 282	DMA 2
....
5 631	DMA 4 351
....
5 888	DMA 4 352
5 889	DMA 4 353
....
10 239	DMA 8 703
....

This method of addressing is named "method 3 addressing" in the *CD-MRW Defect Management & Physical Formatting*.

J.1.4 A CD-MRW Example

J.1.4.1 General

A CD-RW disc is mounted into a MRW capable CD-RW Logical Unit. The lead-in ATIP on this disc indicates that the first lead-in begins at 97:38:20 and the last possible lead-out begins at 75:04:12. The disc is completely formatted as a CD-MRW disc.

The MRW format requires that the program area be formatted as a single track of fixed packets with 32 user sectors each. This yields a maximum of 337 812 sectors within the program area (from

00:00:00 to but not including 75:04:12). The first user sector is found at 00:02:00. This means that the first packet overhead invades the track 1 pre-gap by 5 sectors. So, 337 667 sectors may be dedicated to fixed packets. This yields 8 658 packets with 5 sectors remaining $(337\ 812 - (150 - 5) = 39 * 8\ 658 + 5)$. The 5 extra sectors are moved into the lead-out.

The GAA requires 32 packets from the beginning of the program area while the STA requires 33 packets at the end of the program area. This leaves $8\ 658 - 65 = 8593$ packets for the DMA. Each SA/DA pair is 144 packets in length. $8\ 593 = 59 * 144 + 97$, so there may be 59 SA/DA pairs with 97 packets remaining. Of these 97 packets, 8 are reserved for the final SA, leaving 89 packets for the final DA.

The actual number of user sectors in the DMA is $32 * (59 * 136 + 89) = 25\ 916$.

There are a few significant disc addresses of interest (Table J.1):

Table J.1 – MRW Example: Significant Addresses

MSF	LBA	Significance
00:00:00	-	Start of program area of the disc.
00:02:00	0	First user sector of GAA
00:18:40	1023	Last user sector of GAA
00:18:43	-	Link block separating GAA from DMA
00:22:60	0	First user sector of DMA: First user sector of first packet of first DA
74:48:34	259615	Last user sector of DMA: Last user sector of last packet of last DA
75:04:07	-	Actual lead-out start address: Link block separating last STA packet and lead-out
75:04:12	-	Last possible start time for start of lead-out according to ATIP

After unit attention conditions have been cleared, the Initiator may choose to collect information about this disc.

Next, examples of the data returned for:

- READ CAPACITY
- READ DISC INFORMATION
- READ TRACK INFORMATION
- READ TOC/PMA/ATIP

J.1.4.2 READ CAPACITY Command

The READ CAPACITY command response (Table J.2) is the last LBA in the address space and the block size.

Table J.2 – MRW Example: Read Capacity Results

Byte	Field	Value when LBA Space = GAA	Value when LBA Space = DMA
0..3	Last LBA	1 023 (3FFh)	259 615 (3F61Fh)
4..7	Block size	2 048 (800h)	2 048 (800h)

Regardless of the current LBA Space, the block size is 2 048 bytes (0800h) bytes per sector.

J.1.4.3 READ DISC INFORMATION Command

The READ DISC INFORMATION command is sent to the Logical Unit in order to determine the general status of the disc. The DISC INFORMATION BLOCK is returned.

Examine byte 2, bit 4 (Erasable) first. If this bit is set to zero, then the disc is not CD-RW and consequently is not MRW. It is presumed that this bit is set to one, indicating that this is CD-RW disc. Next check byte 7, bits 1, 0 (BG format status). If the value is 00b, then this disc is not formatted as MRW and furthermore, a MRW format is not in progress.

Let's suppose that BG format status is not 00b. The following table shows the DISC INFORMATION BLOCK contents according to the information known so far:

Table J.3 – MRW Example: Disc Information

Byte	Value	Meaning
0	20h + # OPC bytes	Disc Information Length: At least 32 bytes, but may be longer if OPC information is supported
1		
2	00011110b	General Disc Status: Erasable, Last session is complete session, complete disc
3	1	Number of first track on disc
4	1	Number of sessions
5	1	First track number of last session
6	1	Last track number of last session
7	1x1000mmb	Information Validity: Disc ID is valid, Disc bar code validity - don't care, Unrestricted Use Disc, MRW format is not dirty, Has MRW format in some state
8	20h	Disc Type: CD-ROM XA
9	0	Reserved in the CD case
10	0	Reserved in the CD case
11	0	Reserved in the CD case
12	xxxxxxxh	Disc Identification: From PMA. This should be recorded when the MRW format begins.
13		
14		
15		
16	00612614h	Last Session Lead-in Start time: MSF format. For MRW, this is returned as recorded in lead-in ATIP where each BCD encoded value has been converted to binary (hex).
17		
18		
19		
20	004B040Ch	Last Possible Start Time for Start of Lead-out: MSF format. For MRW, this is returned as recorded in lead-in ATIP where each BCD encoded value has been converted to binary (hex).
21		
22		
23		
24	xxxxh	Disc Bar Code: Valid only if indicated so in byte 7. If not valid, this field should be zero filled.
25		
...		
31		

Bytes beyond byte 31 are present only if the SEND OPC command is supported.

J.1.4.4 READ TRACK INFORMATION Command

Next, our Initiator sends the READ TRACK INFORMATION command for track 1. The TRACK INFORMATION BLOCK is returned as follows:

Table J.4 – MRW Example: Track Information

Byte	Value	Meaning
0	20h	Track Information Length: 32 for CD discs
1		
2	1	Track Number
3	1	Session Number
4	0	Reserved
5	0000 0111b	Track Status: Track mode is incrementally recorded data, copying is not prohibited
6	10110010b	Track Status: Reserved, not blank, fixed packet, mode 2 sectors
7	000000x0b	Validities: Last recorded address - don't care, next writable address - not valid
8	00000000h	Track Start Address: This is given in LBA format. It is always zero for MRW.
9		
10		
11		
12	00000000h	Next Writable Address: Not valid on fixed packet formatted discs. Should be zero filled.
13		
14		
15		
16	00000000h	Free Blocks: Not valid on fixed packet formatted discs. Should be zero filled.
17		
18		
19		
20	00000020h	Fixed Packet Size: This value is 32 for CD MRW
21		
22		
23		
24	GAA: 1 024 DMA: 259 616	Track Size: This is the number of user sectors in the track.
25		
26		
27		
28	xxxxxxxh	Last Recorded Address: Not required.
29		
30		
31		

J.1.4.5 READ TOC/PMA/ATIP Command

J.1.4.5.1 Overview

The READ TOC/PMA/ATIP command requires that the Initiator select one of 6 forms:

- a) form 0: Legacy TOC (from SCSI2)
- b) form 1: Multi-session information
- c) form 2: Full TOC - all information recorded in the lead-in(s), presented in a non-redundant way
- d) form 3: PMA - all information recorded in the PMA, presented in a non-redundant way
- e) form 4: ATIP - disc specific parameters from the disc lead-in, encoded in the ATIP
- f) form 5: CD-TEXT - valid only for CD audio discs

J.1.4.5.2 Form 0 TOC: SCSI-2 TOC, List of Track Descriptors

Table J.5 shows the expected data returned for the form 0 TOC request.

Table J.5 – MRW Example: Form 0 TOC (SCSI-2 TOC)

Byte	MSF = 0	MSF = 1	Meaning
0	18	18	Data length
1			
2	1	1	First Track number
3	1	1	Last Track Number
TOC Descriptor: Track 1			
0	0	0	Reserved
1	17h	17h	ADR/CONTROL
2	1	1	Track Number
3	0	0	Reserved
4	GAA: 0 DMA: 0	GAA: 00:02:00 DMA: 00:22:60	Track Start Address
5			
6			
7			
TOC Descriptor: Lead-out			
0	0	0	Reserved
1	16h	16h	ADR/CONTROL
2	AAh	AAh	Track Number
3	0	0	Reserved
4	GAA: 1 024 DMA: 259 712	GAA: 00:18:43 DMA: 74:48:37	Track Start Address
5			
6			
7			

J.1.4.5.3 Form 1 TOC: Multi-Session Information

Table J.6 shows the expected data returned for the form 0 TOC request.

Table J.6 – MRW Example: Form 1 TOC (Multi-Session)

Byte	MSF = 0	MSF = 1	Meaning
0	10	10	Data length
1			
2	1	1	First Complete Session
3	1	1	Last Complete Session
TOC Descriptor: Multi-Session Descriptor			
0	0	0	Reserved
1	17h	17h	ADR/CONTROL
2	1	1	First Track in Last Complete Session
3	0	0	Reserved
4	GAA: 0 DMA: 0	GAA: 00:02:00 DMA: 00:22:60	Start Address of First Track in Last Complete Session
5			
6			
7			

J.1.4.5.4 Form 2: Full TOC

When the MRW format has completed, form 2 TOC is reported as described for other CD formats (Table J.7). When the MRW format is not complete, the final TOC has not been recorded. In this case, the Logical Unit predicts the TOC content. Since some addresses may have no consistent LBA representation, only the MSF form is supported. Because these are not logical addresses, there is no reference to the LBA Space.

Table J.7 – MRW Example: Form 2 TOC (Full TOC)

Byte	MSF = 1	Meaning
0	xx	Data length
1		
2	1	First Complete Session number
3	1	Last Complete Session Number
TOC Descriptor: Track 1		
0	1	Session Number
1	16h	ADR/CONTROL
2	0	TNO
3	1	POINT: Track number
4	mm:ss:ff	MIN, SEC, FRAME
5		Absolute address of current location
6		
7	0	ZERO
8	00:02:00	PMIN, PSEC, PFRAME
9		Start address of Track
10		
TOC Descriptor: Point A0		
0	1	Session Number
1	16h	ADR/CONTROL
2	0	TNO
3	A0h	POINT
4	mm:ss:ff	MIN, SEC, FRAME
5		Absolute address of current location
6		
7	0	ZERO
8	1	PMIN: First Track Number
9	0	PSEC
10	0	PFRAME

Table J.8 – MRW Example: Form 2 TOC (Full TOC), continued

TOC Descriptor: Point A1		
0	1	Session Number
1	16h	ADR/CONTROL
2	0	TNO
3	A1h	POINT
4	mm:ss:ff	MIN, SEC, FRAME
5		Absolute address of current location
6		
7	0	ZERO
8	1	PMIN: Last Track Number
9	0	PSEC
10	0	PFRAME
TOC Descriptor: Point A2		
0	1	Session Number
1	16h	ADR/CONTROL
2	0	TNO
3	A0h	POINT
4	mm:ss:ff	MIN, SEC, FRAME
5		Absolute address of current location
6		
7	0	ZERO
8	75:05:51	PMIN, PSEC, PFRAME
9		Start time of lead-out
10		
TOC Descriptor: Point C0		
0	1	Session Number
1	16h	ADR/CONTROL
2	0	TNO
3	C0h	POINT
4	xx	MIN: Optimum recording power
5	0	SEC
6	0	FRAME
7	0	ZERO
8	97:38:20	PMIN, PSEC, PFRAME
9		Address of first lead-in according to ATIP
10		

Table J.9 – MRW Example: Form 2 TOC (Full TOC), continued

TOC Descriptor: Point C1		
0	1	Session Number
1	16h	ADR/CONTROL
2	0	TNO
3	C1h	POINT
4	xx	MIN: ATIP Additional information 001, min byte
5	yy	SEC: ATIP Additional information 001, sec byte
6	zz	FRAME: ATIP Additional information 001, frm byte
7	0	ZERO
8	0	PMIN
9	0	PSEC
10	0	PFRAME

J.1.4.5.5 Form 3: PMA

Reporting of the PMA values is not changed due to the MRW format.

J.1.4.5.6 Form 4: ATIP

Reporting of the ATIP values is not changed due to the MRW format.

J.1.4.5.7 Form 5: CD-TEXT

Reporting CD-TEXT data is valid only for CD-DA discs. This form is not valid when a MRW formatted disc is present. If this form is requested, then the Logical Unit terminates the READ TOC/PMA/ATIP command with CHECK CONDITION status and SK/ASC/ASCQ values are set to ILLEGAL REQUEST/INVALID FIELD IN CDB.

J.1.4.6 READ (10), READ (12), READ CD, WRITE (10), WRITE AND VERIFY(10), SEEK(10), VERIFY(10) Commands

Each of these commands requires that the Initiator provide a starting LBA and (except SEEK) a transfer length. The limits of the requested range has always been governed by the maximum LBA value returned by the READ CAPACITY command.

When the MRW Mode Page shows the GAA as current LBA Space, all references to sectors within the range 0 through 1023 are valid. If any of the listed commands references a LBA outside that range, then the command is terminated with CHECK CONDITION status and SK/ASC/ASCQ values are set to ILLEGAL REQUEST/LOGICAL BLOCK ADDRESS OUT OF RANGE.

When the MRW Mode Page shows the DMA as current LBA Space, all references to sectors within the range 0 through 259615 are valid. If any of the listed commands references a LBA outside that range, then the command is terminated with CHECK CONDITION status and SK/ASC/ASCQ values are set to ILLEGAL REQUEST/LOGICAL BLOCK ADDRESS OUT OF RANGE.

J.1.5 Legacy Considerations

J.1.5.1 Overview

This medium may be mounted in several system combinations of Logical Unit and Initiator software. Of course, when all parties are aware of MRW formatted CD-RW media, then there should be no misunderstandings. There is an installed base of Logical Units and software that recognizes this medium differently. Each combination is highlighted here. The greatest attention is given to Initiator and Logical Unit interaction when the two components are both Mount Rainier capable.

Table J.10 – MRW: Legacy Combinations

COMBINATIONS		SOFTWARE	
		Legacy Software System	MRW Aware Software System
H A	Legacy CD-ROM Logical Unit (Multi-read capable)	1A	1B
R D	MRW Compliant CD-ROM Logical Unit	2A	2B
W A	Legacy CD-RW Logical Unit (at least MMC1)	3A	3B
R E	MRW Compliant CD-RW Logical Unit	4A	4B

It is not likely that hardware is “too old”. There are some minimal requirements:

1. Logical Units are minimally compliant with OSTA Multi-read in order to read CD-RW medium.
2. Both CD-ROM and CD-RW Logical Units are minimally compliant with MMC1.
3. A DVD-ROM Logical Unit that meets the first 2 requirements when CD-RW medium is mounted may be viewed as an acceptable legacy CD-ROM Logical Unit.

The Legacy software is presumed to be maximally capable with its companion hardware. In the case of reading, the legacy system software is capable of reading information stored in standard file systems (e.g. ISO9660, UDF, Joliet).

NOTE 41: It is only for the sake of completeness that the potential consequences are described for cases 1A, 1B, 3A, and 3B. It is not possible to correct this situation within this standard. That work has been done in the format definition document: CD-MRW Defect Management & Physical Formatting.

J.1.5.2 Combinations 1A, 1B: Legacy CD-ROM Logical Unit

J.1.5.2.1 Overview

The legacy CD-ROM Logical Unit sees a MRW disc as having a single, closed session that contains a single fixed packet track with length 32 packets. This Logical Unit sees this disc as having a single LBA space that begins at LBA = 0 (00:02:00). The LBAs continue upward, following method 2 addressing (according to Orange Book).

J.1.5.2.2 With Legacy Software

If no file system was placed within the GAA, then the Initiator declares that this disc is not initialized in any recognizable way.

If some file system, recognizable by the system software was placed within the GAA, then it exists entirely within the GAA and makes no references into the DMA. No relocations have been made within the GAA, so there is no loss. The file system within the GAA may contain automatic run software that may provide some special function for the user. Minimally, this contains information as described in the CD-MRW DM & PF.

J.1.5.2.3 With Mount Rainier Aware System Software

Software that is able to recognize and read MRW from a legacy Logical Unit is required to operate differently than software that expects a MRW capable Logical Unit:

In the first case, the system software performs address translations and defect insertions

In the second case, the Logical Unit already does all LBA translations and defect replacements.

J.1.5.2.4 Combinations 2A, 2B: MRW Compliant CD-ROM Logical Unit

When the Logical Unit is capable of correctly reading a MRW disc, the system software initially sees only the LBA Space defined by the DMA. Both legacy and MRW system software sees only the file system installed in the DMA.

The primary difference with a read-only system is GAA access. The legacy software is unaware of the existence of the GAA and is unlikely to understand how to address it. The MRW compliant system software is able to switch addressing to the GAA.

J.1.5.3 Combinations 3A, 3B: Legacy (MMC1) CD-RW Logical Unit

J.1.5.3.1 Overview

The legacy CD-RW Logical Unit is unaware of the MRW format and presents the disc to the Initiator as a single session with one fixed packet written track in which the packet size is 32 and the block type is mode 2, form 1.

J.1.5.3.2 With Legacy System Software

With this combination: this Logical Unit may write and the legacy system software knows how to ask it to write.

J.1.5.3.3 With Mount Rainier System Software

In this case, the Mount Rainier aware software is aware of the unit's inability to perform defect management and sector-addressable writes, and forces read-only access to the medium.

J.1.5.4 Combinations 4A, 4B: MRW Compliant CD-RW Logical Unit

J.1.5.4.1 Overview

The most important of these combinations is the case where the system software is Mount Rainier aware.

J.1.5.4.2 With Legacy System Software

Since the system software is not aware of how to enable writing, the Logical Unit effectively becomes a CD-RW Logical Unit.

J.1.5.4.3 With MRW Aware System Software

Since this represents the future, a great deal of attention needs to be given to how the Logical Unit should implement the updated MMC and how the system software might use the command set to fully utilize the MRW format. This is described from the Initiator perspective.

J.1.5.4.4 Determining the Format State of a New Media

When a new medium is mounted, a media event is generated. This event is typically discovered by polling with the Get Event Status Notification command (GESN).

J.1.5.4.5 Case: Discovering that the Media is Formatted/Formatting as a MRW Disc

The GESN poll reports a NewMedia Media Event.

The GESN poll reports NoEvent (no additional Media Events to report).

The GET CONFIGURATION command is issued, and reports CD-RW Profile and MRW Features as current.

The READ DISC INFORMATION command is issued.

It is discovered that the MRW format status is non-zero.

If formatting was started earlier and needs restarting, then the status is 01b.

If formatting was started earlier and is still running, then the status is 10b.

If formatting has completed, then the status is 11b.

J.1.5.4.6 Case: Discovering Blank Media

The GESN poll reports a NewMedia Media Event.

The GESN poll reports NoEvent (no additional Media Events to report).

The GET CONFIGURATION command is issued, and reports CD-RW Profile as current and MRW Feature as not current or not supported.

The READ DISC INFORMATION command is issued.

It is discovered that the media is RW, BLANK, and the MRW state is 00b.

It may now be concluded that a format is required before this medium may be used as a MRW disc.

J.1.5.4.7 Case: Discovering Non-Blank Media that is not a MRW disc

The GESN poll reports a NewMedia Media Event.

The GESN poll reports NoEvent (no additional Media Events to report).

The GET CONFIGURATION command is issued, and reports CD-RW Profile as current and MRW Feature as not current or not supported.

The READ DISC INFORMATION command is issued.

It is discovered that the media is RW, not BLANK, and the MRW state is 00b.

It may now be concluded that a new format is required before this medium may be used as a CD-MRW disc.

When the time arises to access a disc for writing, the Initiator should be aware of whether or not this disc should be formatted.

J.1.5.5 Doing the Format

J.1.5.5.1 Overview

If it is determined that the currently mounted medium requires formatting before it may be used, and the user desires to format the medium, then:

The parameter list for a FORMAT UNIT command is initialized for Format Type 24h, MRW. It is preferred to have the IMMED bit set to zero. The FORMAT UNIT command is then issued. The FORMAT UNIT command should not terminate until the track 1 PMA entry, the track 1 pre-gap, the GAA and the first SA have been written. This assures no waiting for additional action before writes are accepted. The total elapsed time for a Logical Unit with 4x write capability is less than 10 seconds.

The Initiator writes file system structures for initialization, as required.

If the Format completes, the GESN poll reports a BGformatCompleted Media Event.

If our user wishes to remove the medium, and no BGformatCompleted Media Event has been seen, a CLOSE TRACK/SESSION command is issued to stop the background formatting. For a 4x writing system, the medium is ejected within 1 minute after the user's media removal request was noted.

J.1.5.5.2 Writing User Data to the Medium During Background Format

Once the FORMAT UNIT command has completed, the Initiator may issue WRITE (10) commands for the purpose of initializing the logical volume (e.g. writing initial file system structures). i.e., the Initiator is not required to perform any special functions or sequences of functions in order to write to the medium. When reading this medium Read(10) and Read(12) commands are guaranteed to be accepted. The Initiator should check the CD READ feature to determine if the READ CD and/or READ CD MSF commands are supported.

In order to write the GAA, the Initiator is required to first select the GAA address space using the MRW Mode Page.

J.1.5.5.3 Completing a Format

Suppose that a disc was mounted and our medium identification discovered a disc with incomplete background format. A new FORMAT UNIT command may be issued with the Format Descriptor indicating that the background format should be continued. There are good reasons to not do that.

Suppose a format has begun or a format restart is requested, then sometime after the background part of the format has begun, a CLOSE SESSION is requested in preparation for medium eject. The time required to stop the background format and then close the disc may be up to 30 seconds.

It is possible that a partially formatted disc is mounted only for reading. The Initiator knows best when to restart BG format, so the Initiator is required to restart the BG format.

J.1.5.5.4 Early Eject

The Initiator determines when a BG format is restarted. It follows then, that it is very much the job of the Initiator to ensure that the disc is ejected in a usable state. For this reason the Logical Unit should not take independent action to stop the formatting or close the session. However, the Logical Unit is responsible for protecting a BG format, so the Logical Unit is responsible to disallow improper action. The Logical Unit simply disallows media spin-down or ejects when a BG format is in progress. The behavior is described in 6.5.3.4.11.

J.2 The DVD+MRW Format

J.2.1 Overview

A general description of the MRW format is found in 4.5.

A description of DVD+RW media may be found in *DVD+RW 4,7 Gbytes Basic Format Specifications*. For the purpose of presenting the mapping of MRW onto DVD+RW media it is only necessary to:

- a) Identify the location of the MTA within the lead-in.
- b) Identify the location of the GAA.
- c) Identify the location of the DMA.
- d) Identify the location of the STA within the data zone.
- e) Present use models.

J.2.2 DVD+MRW Structure

The DVD+RW 120-mm one-sided disc has a 4,70GB information zone, while the two-sided disc has 9,40GB. The (one-sided) MRW capacity is either 4,56GB or 4,16GB, based on formatting.

The DVD+RW 80-mm one-sided disc has 1,46GB information zone, while the two-sided disc has 2,92GB. The (one-sided) MRW capacity is 1,33GB.

The Information Zone is divided into the three primary areas: Lead-in, Data Area, and Lead-out.

MRW is mapped onto DVD+RW media as follows (see Figure J.3):

1. The MTA is 128 sectors in length in two 64-sector parts.
2. The GAA is 1 024 sectors in length, beginning with PSN = 30000h
3. The DMA is constructed as follows:
 - a. Spare Area 1 (SA1) has a length of 4 096 sectors.
 - b. The User Data Area (UDA) has a length of 2 227 488 or 2 030 880 sectors on 12cm media and a length of 646 928 on 8cm media.
 - c. Spare Area 2 (SA2) has a length of 61 440 sectors. On 12 cm media, SA2 may optionally have 258 048 sectors.
4. The STA is 1 056 (66 ECC blocks) sectors in length, beginning with PSN = 260120h.
5. The Lead-out begins at PSN = 260540h and has a nominal length of 47 952 sectors

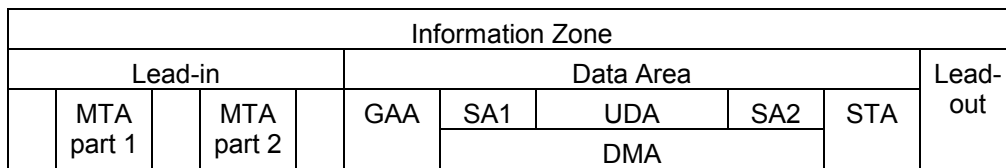

Figure J.3 – MRW Mapping onto DVD+RW, General

The spare block size is 32 768 bytes - one ECC block.

Table J.11 shows the layout of the DVD+MRW formatted groove.

Table J.11 – DVD+MRW Format Lay-out

Disc Area	Zone	12 cm Disc		8 cm Disc		
		Start PSN	Length in Sectors	Start PSN	Length in Sectors	
LEAD-IN	Initial Zone	01D830h	52 304 nominal	01D830h	52 304 nominal	
	Inner Disc Test Zone	02A480h	2 048	02A480h	2 048	
	Inner Drive Test Zone	02AC80h	12 288	02AC80h	12 288	
	Guard Zone 1	02DC80h	512	02DC80h	512	
	MTA, part 1	02DE80h	4 096	02DE80h	4 096	
	MTA, part 2	02EE80h	64	02EE80h	64	
	Inner Disc Identification Zone	02EEC0h	256	02EEC0h	256	
	MTA, part 3	02EFC0h	64	02EFC0h	64	
	Reference Code Zone	02F000h	32	02F000h	32	
	Buffer Zone 1	02F020h	480	02F020h	480	
	Control Data Zone	02F200h	3 072	02F200h	3 072	
	Buffer Zone 2	02FE00h	512	02FE00h	512	
DATA	GAA	030000h	1 024	030000h	1 024	
	DMA	SA1	030400h	4 096	030400h	4 096
		UDA	031400h	2 227 488 or 2 030 880	031400h	646 928
		SA2	251120h/ 221120h	61 440 or 258 048	0CF310h	61 440
	STA	260120h	1056	0DE310h	1056	
LEAD-OUT	Buffer Zone 3	260540h	768	0DE730h	768	
	Outer Disc Identification Zone	260840h	256	0DEA30h	256	
	Guard Zone 2	260940h	4 096	0DEB30h	4 096	
	Reserved Zone 4	261940h	4 096	0DFB30h	4 096	
	Outer Drive Test Zone	262940h	12 288	0E0B30h	12 288	
	Outer Disc Test Zone	265940h	2 048	0E3B30h	2 048	
	Guard Zone 3	266140h	24 400 nominal	0E4330h	7 936 nominal	

J.2.3 Addressing

Table J.11 shows that the GAA begins at PSA = 030000h and the DMA primary space begins at PSA = 031400h.

Logical addressing for the GAA exactly overlaps the logical addressing for first 1 024 sectors of DVD-ROM.

Logical addressing for the primary DMA sectors is exactly DVD-ROM logical addressing plus the offset of 1 400h. The DMA has two possible sizes for SA2 (spare area 2) and consequently, two possible capacities. The specific capacity should be selected at format time.

J.2.4 Using DVD+MRW

J.2.4.1 Overview

Initiator usage of the DVD+MRW format as a data interchange disc is more like a removable magnetic medium than the streamed character of most CD and DVD formats. There are differences due to the multi-use capability of the DVD+RW media.

J.2.4.2 Determining the Format State of a New Media

J.2.4.2.1 General

When a new medium is mounted, a media event is generated. Polling with the Get Event Status Notification Command (GESN) typically discovers this event.

J.2.4.2.2 Case: Discovering that the Media is Formatted/Formatting as a MRW Disc

The GESN poll reports a NewMedia Media Event.

The GESN poll reports NoEvent (no additional Media Events to report).

The GET CONFIGURATION Command is issued, and reports DVD+RW Profile and MRW Features as current.

The READ DISC INFORMATION Command is issued.

It is discovered that the Background format status is non-zero.

If formatting was started earlier and needs restarting, then the status is 01b.

If formatting was started earlier and is still running, then the status is 10b.

If formatting has completed, then the status is 11b.

J.2.4.2.3 Case: Discovering Blank Media

The GESN poll reports a NewMedia Media Event.

The GESN poll reports NoEvent (no additional Media Events to report).

The GET CONFIGURATION Command is issued, and reports DVD+RW Profile as current and MRW Feature as not current or not supported.

The READ DISC INFORMATION Command is issued.

It is discovered that the media is RW, BLANK, and the MRW state is 00b.

It may now be concluded that a format is required before this medium may be used as a MRW disc.

J.2.4.2.4 Case: Discovering Non-Blank Media that is not a MRW disc

The GESN poll reports a NewMedia Media Event.

The GESN poll reports NoEvent (no additional Media Events to report).

The GET CONFIGURATION Command is issued, and reports DVD+RW Profile as current and MRW Feature as not current or not supported.

The READ DISC INFORMATION Command is issued.

It is discovered that the media is RW and not BLANK.

It may now be concluded that a new format is required before this medium may be used as a MRW disc.

J.2.4.3 Formatting

J.2.4.3.1 Overview

If it is determined that the currently mounted medium requires formatting before it may be used, and the user desires to format the medium, then:

The parameter list for a FORMAT UNIT Command is initialized for Format Type 24h, MRW. It is preferred to have the IMMED bit set to zero. The FORMAT UNIT Command is then issued. The FORMAT UNIT Command does not terminate until the MTA and the GAA have been initialized. This assures no waiting for additional action before writes are accepted.

The Initiator writes file system structures for initialization, as required.

If the Format completes, the GESN poll reports a BGformatCompleted Media Event.

If our user wishes to remove the medium, and no BGformatCompleted Media Event has been seen, a CLOSE TRACK/SESSION Command is issued to stop the background formatting.

J.2.4.3.2 Writing User Data to the Medium During Background Format

Once the FORMAT UNIT Command has completed, the Initiator may issue WRITE commands for the purpose of initializing the logical volume (e.g. writing initial file system structures). i.e., the Initiator is not required to perform any special functions or sequences of functions in order to write to the medium.

In order to write the GAA, the MRW Mode Page should be written for addressing that area.

J.2.4.3.3 Reading User Data from the Medium During Background Format

Whenever the Initiator requests information that reports capacity in any way, the Logical Unit responds as if the format had completed. For this reason, all addresses within the range of the currently active MRW address space is made to appear accessible by the Initiator.

For each requested sector that has already been written either by the Initiator or the format process, the Logical Unit returns the written data.

For each requested sector that has not yet been written by either the format process or the Initiator (since the format process began) the Logical Unit returns data as if the format process had written the sector.

J.2.4.3.4 Completing a Format

Suppose that a disc was mounted and our medium identification discovered a disc with incomplete background format. A new FORMAT UNIT Command may be issued with the Format Descriptor indicating that the background format be continued. There are good reasons to not do that.

Suppose a format has begun or a format restart is requested, then sometime after the background part of the format has begun, a CLOSE SESSION is requested in preparation for medium eject. The time required to stop the background format and then close the disc may be up to 30 seconds.

It is possible that a partially formatted disc is mounted only for reading. The Initiator knows best when to restart BG format, so the Initiator should initiate the BG format restart.

J.2.4.3.5 Early Eject

The Initiator is determines when a restart format is started. It should be clearly specified that it is very much the job of the Initiator to assure that the disc is ejected in a usable state. For this reason the Logical Unit should not take independent action to stop the formatting or close the session. However, the Logical Unit is the last place when formats may be protected, so the Logical Unit is responsible to disallow improper action. The Logical Unit simply disallows media spin-down or eject when a background format is in progress.

J.2.4.4 Accessing the Media

Once the formatting process has reached the point that the background format status is either "format in progress" regardless of the running condition, the entire address space of the currently addressed MRW Address space is available to the Initiator. So, reading and writing after the format has completed is no different than reading and writing during the format process.

**This page is intentionally
blank.**

END